

WIRELESS REMOTE

Operations Guide





SIMPLY. CLEARLY. BETTER.

THANK YOU!

Thank you for choosing Humminbird®, the #1 name in marine electronics. Humminbird has built its reputation by designing and manufacturing top-quality, thoroughly reliable marine equipment. Your Humminbird is designed for trouble-free use in even the harshest marine environment. In the unlikely event that your Humminbird does require repairs, we offer an exclusive Service Policy. For complete details, see the Warranty section of this manual. We encourage you to read this manual carefully in order to get full benefit from all the features and applications of your Humminbird product.

Contact Humminbird Customer Service at humminbird.com or call **1-800-633-1468**.

 **WARNING!** This device should not be used as a navigational aid to prevent collision, grounding, boat damage, or personal injury. When the boat is moving, water depth may change too quickly to allow time for you to react. Always operate the boat at very slow speeds if you suspect shallow water or submerged objects.

 **WARNING!** The electronic chart in your Humminbird unit is an aid to navigation designed to facilitate the use of authorized government charts, not to replace them. Only official government charts and notices to mariners contain all of the current information needed for the safety of navigation, and the captain is responsible for their prudent use.

 **WARNING!** Humminbird is not responsible for the loss of data files (waypoints, routes, tracks, groups, recordings, etc.) that may occur due to direct or indirect damage to the unit's hardware or software. It is important to back up your control head's data files periodically. Data files should also be saved to your PC before restoring the unit's defaults or updating the software. Visit our Web site at humminbird.com for more information.

 **WARNING!** Disassembly and repair of this electronic unit should only be performed by authorized service personnel. Any modification of the serial number or attempt to repair the original equipment or accessories by unauthorized individuals will void the warranty.

 **WARNING!** Do not travel at high speed with the unit cover installed. Remove the unit cover before traveling at speeds above 20 mph.

 **NOTE:** Some features discussed in this manual require a separate purchase, and some features are only available on international models. Every effort has been made to clearly identify those features. Please read the manual carefully in order to understand the full capabilities of your model.

 **NOTE:** The illustrations in this manual may not look the same as your product, but your unit will function in the same way.

 **NOTE:** To purchase accessories or any additional equipment for your control head configuration, go to humminbird.com or contact Humminbird Customer Service at **1-800-633-1468**.

 **NOTE:** The procedures and features described in this manual are subject to change without notice. This manual was written in English and may have been translated to another language. Humminbird is not responsible for incorrect translations or discrepancies between documents.

 **NOTE:** Product specifications and features are subject to change without notice.

ATTENTION INTERNATIONAL CUSTOMERS: Products sold in the U.S. are not intended for use in the international market. Humminbird international units provide international features and are designed to meet country and regional regulations. Languages, maps, time zones, units of measurement, and warranty are examples of features that are customized for Humminbird international units purchased through our authorized international distributors.

To obtain a list of authorized international distributors, please visit our Web site at **humminbird.com** or contact Humminbird Customer Service at **(334) 687-6613**.

360 Imaging™, Down Imaging®, DualBeam PLUS™, HELIX®, Humminbird®, i-Pilot® Link™, ONIX®, Side Imaging®, and SOLIX® are trademarked by or registered trademarks of Johnson Outdoors Marine Electronics, Inc.

Baekmuk Batang, Baekmuk Dotum, Baekmuk Gulim, and Baekmuk Headline are registered trademarks owned by Kim Jeong-Hwan.

The *Bluetooth*® word mark and logos are registered trademarks owned by the Bluetooth SIG, Inc. and any use of such marks by Johnson Outdoors, Inc. is under license. Other trademarks and trade names are those of their respective owners.

TABLE OF CONTENTS

Warnings	1
Introduction	5
Control Head Compatibility	5
Confirm Network Installation	5
Update Software	5
Wireless Remote Setup	6
1. Install the Battery in the Remote	6
2. Attach the Lanyard	7
Installation Preparation (Remote with Dongle)	8
1. Connect the Dongle to the Control Head	8
2. Confirm the Connection	9
3. Test the Remote	10
Install the Dongle on the Boat (optional)	11
1. Determine the Mounting Location	11
2. Install the Dongle	12
Connect Cables	13
Getting Started	15
1. Power On	15
2. Confirm Connection on the Control Head	15
Wireless Remote Overview	18
Assign Key Functions on the Wireless Remote	19
Additional Wireless Remote Features	25
Data Box View	25
Troubleshooting	30
Statements and Acknowledgements	31

TABLE OF CONTENTS

1-Year Limited Warranty	33
Humminbird Service Policy	33
Returning Your Unit for Service	34
Contact Humminbird	35

INTRODUCTION

This accessory allows you to quickly initiate commands on the Humminbird control head using the wireless remote.

This manual will guide you through the following installation and setup instructions:

- Set Up the Wireless Remote
- Test the Remote and Dongle
- Install the Dongle on the Boat [optional]
- Confirm Connection on the Control Head
- Assign Key Functions on the Wireless Remote

Control Head Compatibility

This accessory is compatible with multiple Humminbird fishing systems. To review the latest compatibility information, visit our Web site at **humminbird.com** or contact Humminbird Customer Service.

The remote-only option [AS RC2] is compatible with all control heads that have built-in *Bluetooth*® technology. For non-Bluetooth models, use the remote and wireless dongle [AS RC1].



NOTE: For a list of all Bluetooth-enabled control heads, visit our Web site at **humminbird.com**.

Confirm Network Installation

Confirm all Humminbird control heads and sources [GPS, transducers, temp/speed accessories, etc.] are properly installed and connected to the control head [or network, depending on your network configuration].



NOTE: Consult your control head installation guide and the installation guide provided with each accessory, or download the guide from our Web site at **humminbird.com**, for installation instructions.

Update Software

See your control head operations manual for information and instructions about updating software. Operations manuals can be downloaded from our Web site at **humminbird.com**.

Customer Service: If you have any questions about the software update process, visit our Web site at **humminbird.com** or call Humminbird Customer Service at **1-800-633-1468**.



WARNING! Humminbird is not responsible for the loss of data files [waypoints, routes, tracks, groups, snapshots, recordings, etc.] that may occur due to direct or indirect damage to the unit's hardware or software. It is important to back up your control head's data files periodically. Data files should also be saved to your PC before restoring the unit's defaults or updating the software. Visit our Web site at **humminbird.com** for more information.

WIRELESS REMOTE SETUP

Perform the procedures in the following sections to set up the wireless remote.

SUPPLIES: In addition to the hardware supplied with your accessory, you will need a Phillips screwdriver.

1 | Install the Battery in the Remote

Use the following instructions to install the battery [included] in the wireless remote.

1. Locate the battery door on the back of the remote.
2. Use a Phillips screwdriver to loosen the screw.
3. Remove the battery door and set aside.
4. Insert the battery with the positive side facing up [the battery number and plus sign should be facing up].
5. Replace the battery door on the remote.
6. Hand-tighten the screw using a Phillips screwdriver.
Do not over-tighten!

Removing the Battery Door

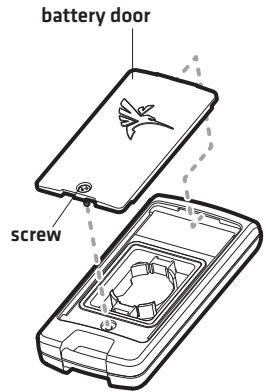

Replacing the Battery

When the battery life is low, use the instructions in the section above to replace the battery. The remote requires a CR 2032 Lithium Cell Battery.



ONIX and HELIX NOTE: A battery status icon is displayed in the Data Box View to show the current battery life [see **Additional Wireless Remote Features: Data Box View**]. If the remote hasn't been used for several seconds, the remote will enter power save mode. When the remote is in power save mode, the battery status icon will be removed from the Data Box View and the remote will be listed as disconnected. You can resume operation at any time by pressing any key on the remote.



SOLIX NOTE: The battery status icon is available under the Options menu [Bluetooth tool > Remote Options > Battery Status]. If the remote hasn't been used for several seconds, the remote will enter power save mode. When the remote is in power save mode, the battery status icon will change to sleep mode in the status bar.

Installing the Battery

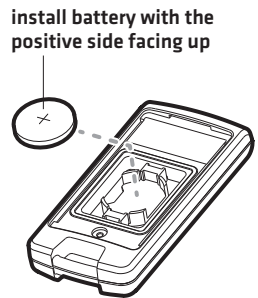

2 | Attach the Lanyard

Use the following instructions to attach the lanyard to the wireless remote.

1. Attach the Lanyard Connector to the Remote

1. Insert the loop on the lanyard connector through the opening on the bottom of the remote.
2. Pull the lanyard connector through the loop to secure the lanyard connector to the remote. See the illustration *Installing the Lanyard Connector on the Remote*.

Installing the Lanyard Connector on the Remote

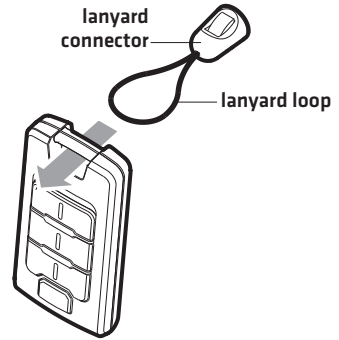

2. Connect the Lanyard

1. Insert the clip on the lanyard into the lanyard connector until you hear it click into place.

Connecting the Lanyard

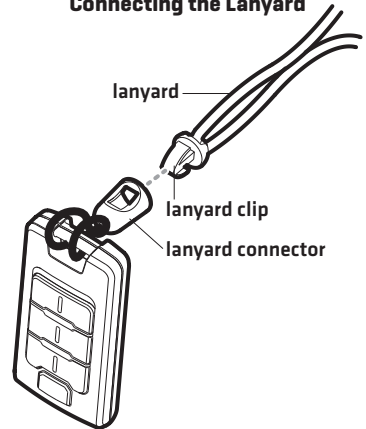

Disconnect the Lanyard

1. Pinch the sides of the lanyard clip, then gently pull the lanyard clip out of the lanyard connector.

Disconnecting the Lanyard

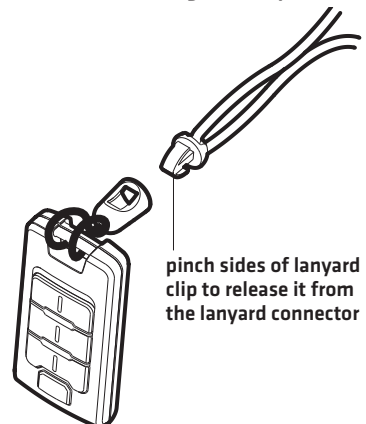

INSTALLATION PREPARATION (REMOTE WITH DONGLE)

Prior to installing the dongle on the boat, test the wireless remote and dongle to confirm connection and operation. This section is applicable to all control heads without built-in Bluetooth technology.

Purchase Connection Accessories

Depending on your Humminbird control head model and network configuration, you may need to purchase additional accessories and/or extension cables. See the table below for the required cable[s] for your configuration.



NOTE: To purchase accessories or any additional equipment for your control head configuration, visit our Web site at humminbird.com or contact Humminbird Customer Service at **1-800-633-1468**.



NOTE: Extension cables may affect performance.

Hardware	Required Cables
ONIX	[1] AS GPS NMEA

1 | Connect the Dongle to the Control Head

Refer to your control head installation guide for more information about connecting cables.



NOTE: Confirm all control heads are powered off before proceeding with the installation.



NOTE: The connectors are keyed to prevent incorrect installation, so be careful not to force the connectors into the ports.



NOTE: Extension cables may affect performance.

ONIX

1. Connect the AS GPS NMEA cable connector to the cable connector on the dongle cable.
2. Connect the AS GPS NMEA cable connector to the **NMEA 0183 [1-2] port** on the back of the control head.
3. Hand-tighten the screw nut to secure the connection.

Connecting the Dongle to the NMEA 0183 (1-2) Port on the ONIX Control Head

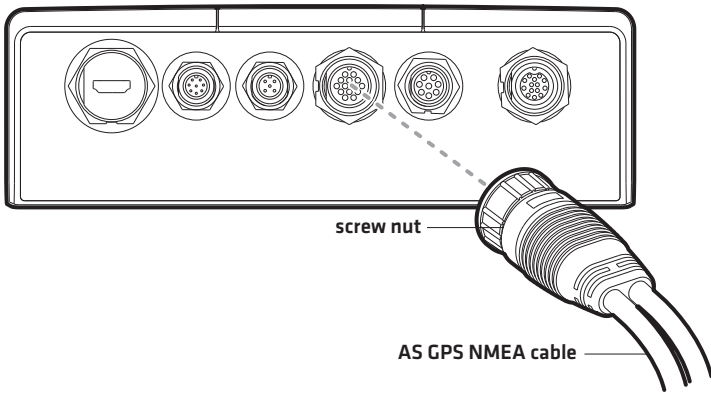

HELIX

1. Connect the dongle cable connector to the **Communications (COM)** port on the back of the control head.

Connecting the Dongle to the COM Port on the HELIX Series Control Head

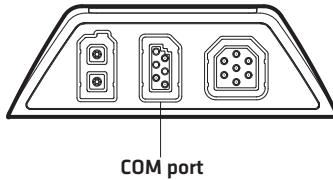

NOTE: The location of the Communications (COM) port will vary based on your control head model. See your control head installation guide for more details.

2 | Confirm the Connection

Use the following instructions to confirm wireless connection on the control head. Also, see the section **Getting Started: Confirm Connection on the Control Head**.

1. Power on the control head.
2. Confirm the wireless remote and dongle connection:

ONIX: Select **Settings > Network > Network Info**. Confirm the dongle and wireless remote are listed under This Unit.

HELIX: Press the VIEW key until the **Accessory Test View** is displayed. Confirm the dongle and wireless remote are listed under Accessory Test.



NOTE: If the Accessory Test View is not displayed in the view rotation, confirm it is set to visible in the menu system.



NOTE: If the remote hasn't been used for several seconds, the remote will enter power save mode. When the remote is in power save mode, the battery status icon will be removed from the Data Box View and the remote will be listed as disconnected. You can resume operation at any time by pressing any key on the remote.

3 | Test the Remote

1. Select a view to display on-screen.
2. **Test the Remote:** Press the Data Box key  once. Confirm the Data Box View displays on the control head.
3. Press the Data Box key again. Confirm the Data Box View closes.
4. **Repeat:** Walk around the boat and repeat steps 2 and 3 to confirm that there is no interference from any location on the boat.

INSTALL THE DONGLE ON THE BOAT (OPTIONAL)

The dongle is designed to mount on any flat, level surface on your boat using the screws provided in the installation kit. Use the following instructions to install the dongle on your boat.

Installing the dongle on the boat is optional and is only applicable to the remote with dongle [AS RC 1] accessory for control heads without Bluetooth technology. To skip this procedure, proceed to **Getting Started**.

SUPPLIES: In addition to the hardware supplied with your installation kit, you will need a powered hand drill, 7/64" drill bit, various Phillips screwdrivers, safety goggles, dust mask, level, and a pencil.

1 | Determine the Mounting Location

Prior to installation, you must first determine where to mount the dongle with the following requirements:

- **Interference:** The mounting location must provide adequate distance between the dongle and any of the following materials:
 - metal surfaces
 - compass or other magnetic equipment
 - electric motors or any equipment that may cause electronic interference.
 - **Stability:** The mounting location should be protected from waves, shock, vibration, and water.
 - **Surface Space:** The mounting location should allow adequate room around the dongle, so the top and sides of the dongle do not touch other equipment or surfaces.
1. Use a level to locate a suitable, flat area to mount the dongle.
 2. Test route all appropriate cables to the dongle [AS GPS NMEA, GPS Receiver] based on the configuration for your control head [see **Connect Cables**].



NOTE: To purchase accessory cables, visit our Web site at **humminbird.com** or call Humminbird Customer Service.



NOTE: Extension cables may affect performance.

2 | Install the Dongle

Once you have determined the mounting location, perform the following procedures to install the dongle on your boat.

1. Set the dongle in place on the mounting surface. Mark the two mounting screw locations with a pencil, and set the dongle aside.
2. Drill the two mounting holes using a 7/64" drill bit.



NOTE: On fiberglass hulls, it is best to use progressively larger drill bits to reduce the chance of chipping or flaking the outer coating.



NOTE: If the mounting surface is thin or made of lightweight material, you may need to add reinforcing material below the mounting surface in order to support the dongle.

3. Place the dongle on the mounting surface and align the screw holes with the drilled mounting holes. Insert the two #6-20 screws [included] through the screw holes and into the drilled mounting holes. Hand-tighten using a Phillips screwdriver. **Hand-tighten only!**

Installing the Dongle on the Boat

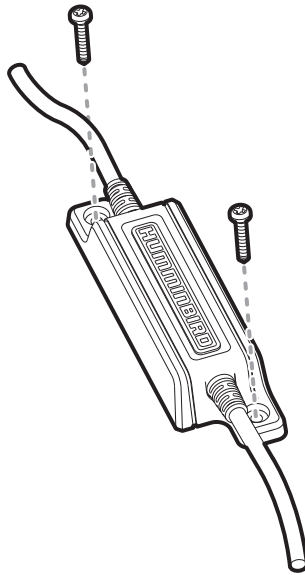

NOTE: Apply marine-grade silicone caulk or sealant [separate purchase required] to both screws and drilled holes as needed to protect your boat from water damage.

CONNECT CABLES (REMOTE WITH DONGLE)

Refer to the section for your control head to perform the following procedures:

- Connect the dongle to the control head
- Connect a GPS Receiver to the dongle (optional, depending on your network configuration)



WARNING! Turn off power for all related equipment before you start the installation.



NOTE: Refer to your control head installation guide for additional information about connecting cables.



NOTE: Extension cables may affect performance.

ONIX

To connect the dongle to the ONIX control head, you will need the AS GPS NMEA accessory cable.

1. Connect the Dongle to the Control Head

1. Connect the AS GPS NMEA cable connector to the dongle cable connector.
2. Route the AS GPS NMEA cable to the control head.
3. Connect the cable connector to the **NMEA 0183 [1-2] port** on the back of the control head.
4. Hand-tighten the screw nut to secure the connection.

2. Connect the GPS Receiver to the Dongle (optional)

If you have an external GPS Receiver connected to your network, use the following instructions to connect the GPS to the dongle.

1. Route the GPS cable to the dongle.
2. Connect the GPS cable connector to the dongle cable connector.

ONIX Configuration

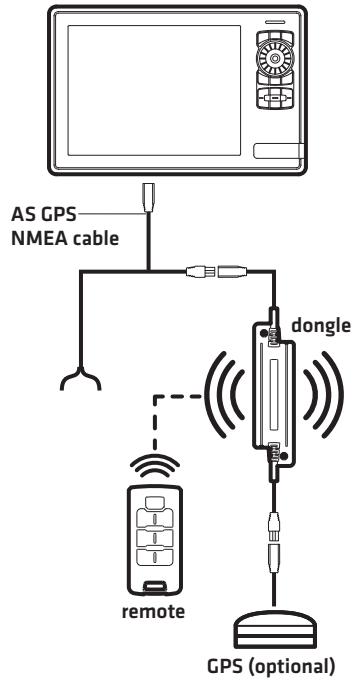

HELIX

The dongle connects directly to the HELIX control head.

1. Connect the Dongle to the Control Head

1. Route the dongle cable to the control head.
2. Connect the dongle cable connector to the **Communications [COM] port**.

2. Connect the GPS Receiver to the Dongle [optional]

If you have an external GPS Receiver connected to your network, use the following instructions to connect the GPS to the dongle.

1. Route the GPS cable to the dongle.
2. Connect the GPS cable connector to the dongle cable connector.

HELIX Configuration

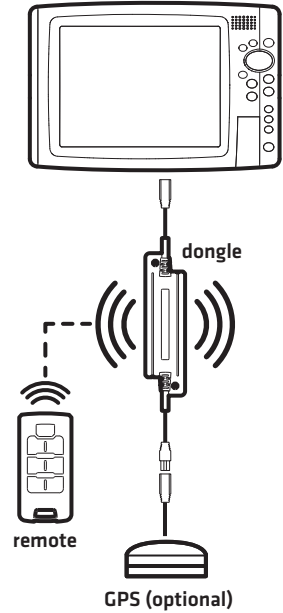

GETTING STARTED

Proceed to the following sections to get started using the wireless remote.

1 | Power On

1. Press the POWER key to power on your control head.
2. Start Normal operation.

2 | Confirm Connection on the Control Head



NOTE: If the remote hasn't been used for several seconds, the remote will enter power save mode. When the remote is in power save mode, the battery status icon will be removed from the Data Box View and the remote will be listed as disconnected. You can resume operation at any time by pressing any key on the remote.

SOLIX

Use the following instructions to confirm wireless connection on the SOLIX control head.

1. From the Home screen, select Settings.
2. Select **Network > Network Info**.
3. Confirm the wireless remote is listed under This Unit.



NOTE: The remote icon is also available under the status bar.

Confirming Connection on SOLIX

The screenshot shows the SOLIX control head settings menu. The 'Network' section is highlighted, and the 'Network Info' dialog is open. The 'Network Info' dialog shows the following information:

NET:161014220399			
Rename Network			
This Unit: 161014220399			
Model:	SOLIX 12 S100	Serial Number:	161014220399
Unit Name:	161014220399	IP Address:	
Software Version:	3.100	MAC Address:	74:DA:EA:0A:00:2A
Remote			
Model:	RM11	Battery Status:	100%
Software Version:	101.060		

The 'Remote' section shows the remote is connected and the battery status is 100%. A red arrow points to the 'Remote' section with the text 'confirm the remote connection'. Another red arrow points to the remote icon in the status bar with the text 'remote icon in status bar'.

ONIX

Use the following instructions to confirm wireless connection on the ONIX control head.

1. From the Home screen, select Settings.
2. Select **Network > Network Info**.
3. Confirm the dongle and wireless remote are listed under This Unit.

Confirming Connection on ONIX



HELIX

Use the following instructions to confirm wireless connection on the HELIX control head.

1. Press the VIEW key until the **Accessory Test View** is displayed.



NOTE: If the Accessory Test View is not displayed in the view rotation, confirm it is set to visible in the menu system.

2. Confirm the wireless remote [Bluetooth models] or the dongle and wireless remote [non-Bluetooth models] are listed under Accessory Test.

Confirming Connection on HELIX (non-Bluetooth model)

Depth		ft		Accessory Test	
40.6		GPS		CONNECTED	
Temp		°F		Remote	CONNECTED
69.4		Remote Dongle		CONNECTED	
N 34°06.257'		Speed		UNCONNECTED	
W 084°12.398'		Temperature		UNCONNECTED	
Time					
9:19					
Speed		mph			
1.4					

confirm
dongle
and remote
connection

WIRELESS REMOTE OVERVIEW

The wireless remote includes multiple keys that allow you to quickly perform various actions on the control head. For example, use the remote to mark waypoints, open menus, adjust settings, display views, etc.

Some keys on the wireless remote include both a **single press function** and a **press and hold function**. Also, some keys include default settings and some keys are customizable. See the table below for an overview of the wireless remote keys and key functions.

Remote Keys

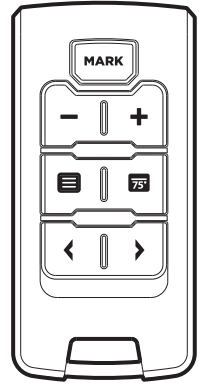

Remote Key	Single Press Function	Press and Hold Function
MARK	Press the MARK key to mark a waypoint.	Customizable, see <i>Assign Key Functions on the Wireless Remote</i> .
- +	The PLUS [+] and MINUS [-] keys are customizable, see <i>Assign Key Functions on the Wireless Remote</i> . For example, you can program the PLUS and MINUS keys to adjust the Chart Speed setting in Sonar View.	
	The MENU key is customizable, see <i>Assign Key Functions on the Wireless Remote</i> . For example, you can program the MENU key to start and stop Sonar Recording in Side Imaging View.	Customizable, see <i>Assign Key Functions on the Wireless Remote</i> .
	Press the DATA BOX key to display the Data Box View. See <i>Additional Wireless Remote Features: Data Box View</i> .	With the Data Box View displayed on-screen, press and hold the DATA BOX key for several seconds to display different data boxes. See <i>Additional Wireless Remote Features: Data Box View</i> .
< >	The ARROW keys are used to cycle through all available views. With a view displayed on-screen, press either ARROW key repeatedly until the view you want to use is displayed on the screen. Next View: Press the RIGHT ARROW key. Previous View: Press the LEFT ARROW key.	

ASSIGN KEY FUNCTIONS ON THE WIRELESS REMOTE

The customizable keys on the wireless remote can be programmed to perform various actions when different views are displayed on-screen [Sonar, Chart, Radar, etc.].

Before proceeding, review the following information:

- The available **PLUS/MINUS** and **MENU key functions** are listed under the submenu for each view in the Bluetooth tool [SOLIX], the Wireless Remote tool [ONIX], and the Wireless Remote Menu [HELIX].
- The available **MARK key press and hold** functions are listed in the submenu under **Options** in the Bluetooth tool [SOLIX], the Wireless Remote tool [ONIX], and the Wireless Remote Menu [HELIX].
- Depending on your network configuration, there may be additional key function options for connected accessories or installed map cards. Any additional options will be listed under the submenu for each view or under Options in the Bluetooth tool [SOLIX], the Wireless Remote tool [ONIX], and the Wireless Remote Menu [HELIX].

Refer to the section for your control head model to assign key functions on the wireless remote.

SOLIX

On SOLIX control heads, the wireless remote settings are located in the **Bluetooth tool**.

Opening the Wireless Remote Tool [SOLIX]

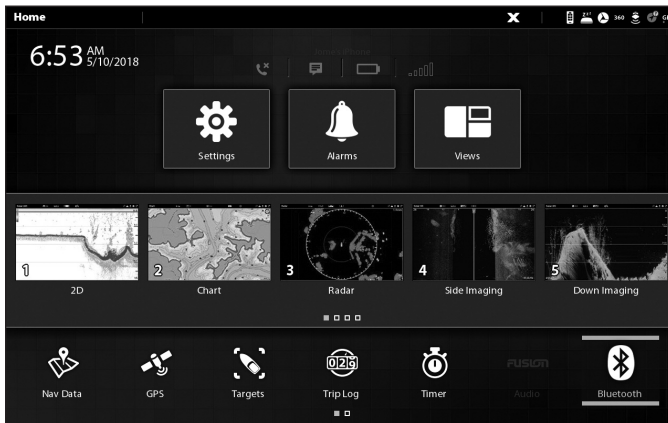

1. Assign the PLUS/MINUS and MENU Key Functions

1. Press the HOME key.
2. Tap the Bluetooth tool.

OR

Use the Joystick to select the Bluetooth tool and press the ENTER key.

3. Under Wireless Remote, select a view. Tap, or press the ENTER key, to select.
4. Select a key [+/- Keys, Menu Key, Menu Key [Press and Hold]].
5. Select a key function.
6. Tap the Back icon, or press the EXIT key, to return to the previous menu.
7. **Repeat:** Repeat steps 3 through 6 to assign additional key functions.

Selecting a View and Key [SOLIX]

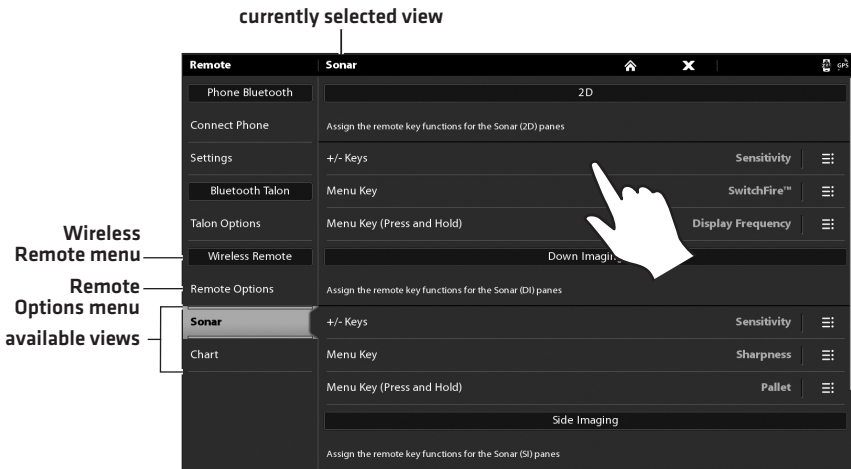

2. Assign the MARK Key [Press and Hold] Function

1. Open the Bluetooth tool.
2. Under Wireless Remote, select **Remote Options**. Tap, or press the ENTER key, to select.
3. Select MARK Key [Press and Hold].
4. Select a key function.
5. Tap the Back icon, or press the EXIT key, to return to the previous menu.

On ONIX control heads, the wireless remote settings are located in the **Wireless Remote tool**.

Opening the Wireless Remote Tool (ONIX)



1. Assign the PLUS/MINUS and MENU Key Functions

1. Press the HOME key.
2. Tap the Wireless Remote tool.

OR

Use the Joystick to select the Wireless Remote tool and press the ENTER key.

3. Under Key Settings, select a view. Tap, or press the ENTER key, to select.
4. Select a key.
5. Select a key function.
6. Tap the X icon, or press the EXIT key, to return to the previous menu.
7. **Repeat:** Repeat steps 3 through 6 to assign additional key functions.

Selecting a View and Key (ONIX)

currently selected view

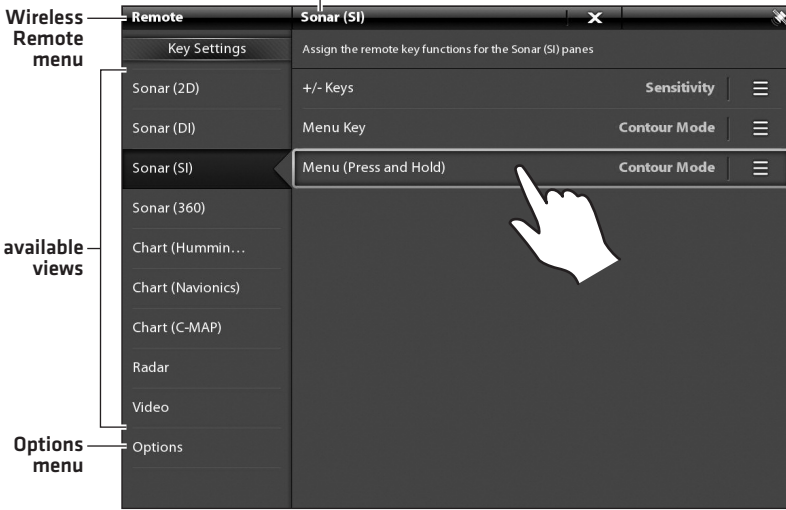

Assigning the Key Function (ONIX)

currently selected key

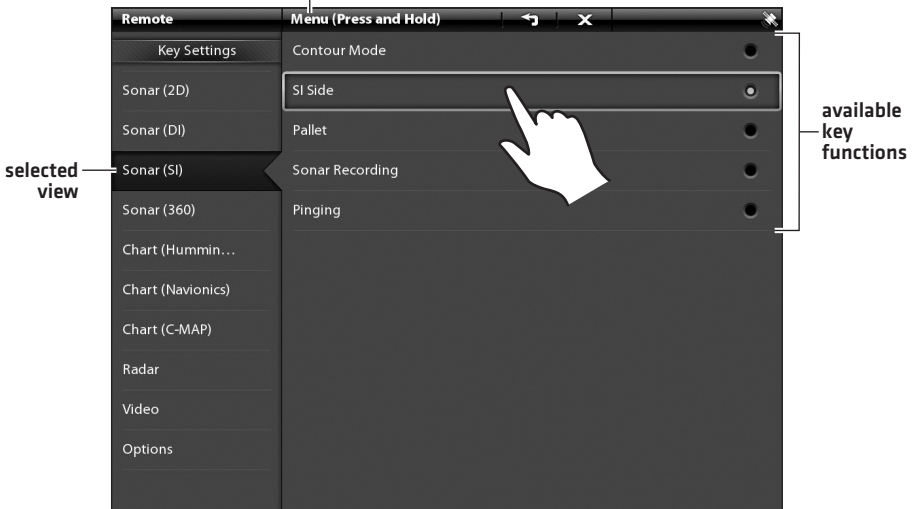

NOTE: See your control head operations manual for more information about the menu settings for Sonar, Chart, Radar, etc.

2. Assign the MARK Key [Press and Hold] Function

1. Open the Wireless Remote tool.
2. Under Key Settings, select **Options**. Tap, or press the ENTER key, to select.
3. Select MARK [Press and Hold].
4. Select a key function.
5. Tap the X icon, or press the EXIT key, to return to the previous menu.

HELIX

On HELIX control heads, the Wireless Remote Menu is located under the **Accessories Menu** tab.

Opening the Wireless Remote Menu (HELIX)

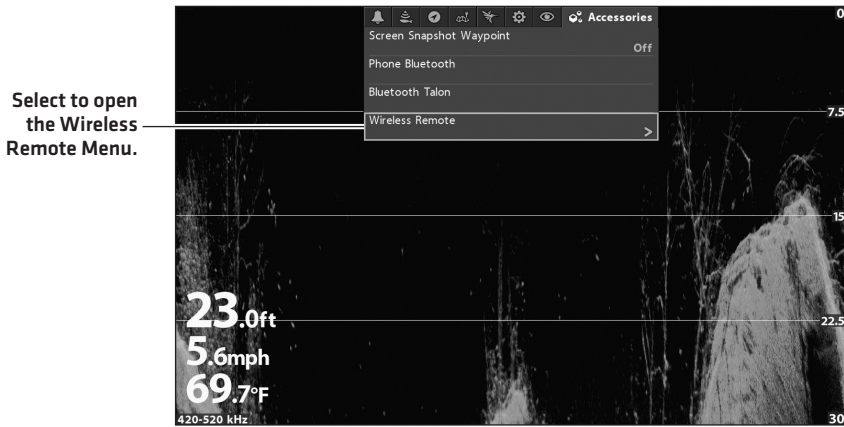

1. Assign the PLUS/MINUS and MENU Key Functions

1. Press the MENU key twice to access the Main Menu.
2. Press the RIGHT Cursor key until the Accessories Menu tab is selected.
3. Select **Wireless Remote**. Press the RIGHT Cursor key to open the Wireless Remote Menu.
4. Press the UP or DOWN Cursor keys to select a view [Sonar, Chart, Radar, etc.].
5. Press the RIGHT Cursor key to open the submenu.
6. Press the UP or DOWN Cursor keys to select a key function, and press the ENTER key to select.
7. Press the EXIT key to return to the previous menu.
8. **Repeat:** Repeat steps 4 through 7 to assign additional key functions.

2. Assign the MARK Key (Press and Hold) Function

1. Open the Wireless Remote Menu [Accessories Menu tab > Wireless Remote].
2. Select **Options**. Press the RIGHT Cursor key to open the submenu.
3. Select MARK (Press and Hold). Press the RIGHT Cursor key to open the submenu.
4. Press the UP or DOWN Cursor keys to select a key function, and press the ENTER key to select.
5. Press the EXIT key to return to the previous menu.

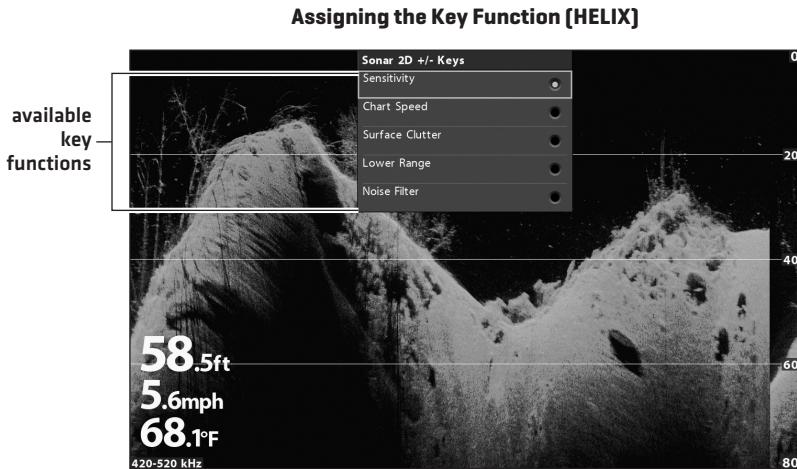

ADDITIONAL WIRELESS REMOTE FEATURES

Review the following sections for additional wireless remote features.

Data Box View

The Data Box View is a full screen display of data [or digital readout] boxes. Before proceeding, review the following information:

- **Data Box View [1] and Data Box View [2]:** There are two Data Box Views available; each one displays different data boxes. To switch between the two views, press and hold the DATA BOX key.
- **SOLIX and ONIX:** The data boxes in the Data Box Views can be customized, see the section *Edit the Data Boxes in the Data Box View [SOLIX and ONIX only]*.
- **Remote Battery Status Icon:** The Data Box View includes a battery status icon that displays the remaining battery life of the wireless remote [ONIX and HELIX only]. When the battery life appears low, replace the battery [see *Wireless Remote Setup: Install the Battery in the Remote*].



NOTE: If the remote hasn't been used for several seconds, the remote will enter power save mode. When the remote is in power save mode, the battery status icon will be removed from the Data Box View and the remote will be listed as disconnected. You can resume operation at any time by pressing any key on the remote.



SOLIX NOTE: The battery status icon is available under the Remote Options menu [Bluetooth tool > Remote Options > Battery Status].



NOTE: See your control head operations manual for more information about data or digital readout boxes.

Display the Data Box View

1. Press the DATA BOX key  once on the wireless remote.
2. **Close:** Press the DATA BOX key to close the Data Box View.

Switch Between Data Box View [1] and Data Box View [2]

1. Press and hold the DATA BOX key on the wireless remote.
2. **Close:** Press the DATA BOX key to close the Data Box View.

Data Box View [1] (ONIX)

remote battery status icon

Depth (1)	Temp (1)
ft	°F
42.3	63.8
SOG	Hdg
mph	°T
17.2	115.5

Data Box View [1] (HELIX)

Depth	ft	Speed	mph
57.2		0.0	
Voltage	V	Course	°t
13.9		261	

remote battery status icon

Edit the Data Boxes in the Data Box View (SOLIX and ONIX only)

1. **SOLIX:** Open the Bluetooth tool.
ONIX: Open the Wireless Remote tool.
2. **SOLIX:** Select **Remote Options > Edit Data Box**.
ONIX: Select **Options > Edit Data Box**.
3. Select a data box to edit. Tap the box, or use the Joystick to select it and press the ENTER key.
4. Select the data type from the menu.
5. Select a data label for the data box. Tap, or press the ENTER key, to select.
6. **Close:** Press the EXIT key twice.
7. **Repeat:** Repeat steps 3 through 6 to edit additional data boxes, as needed.

Selecting the Data Type (SOLIX)

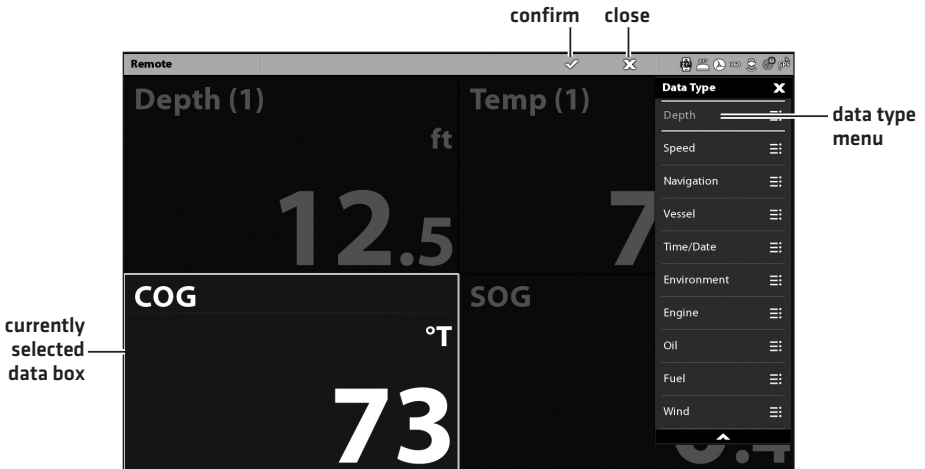

Selecting the Data Label (SOLIX)



Opening the Edit Data Box Menu (ONIX)

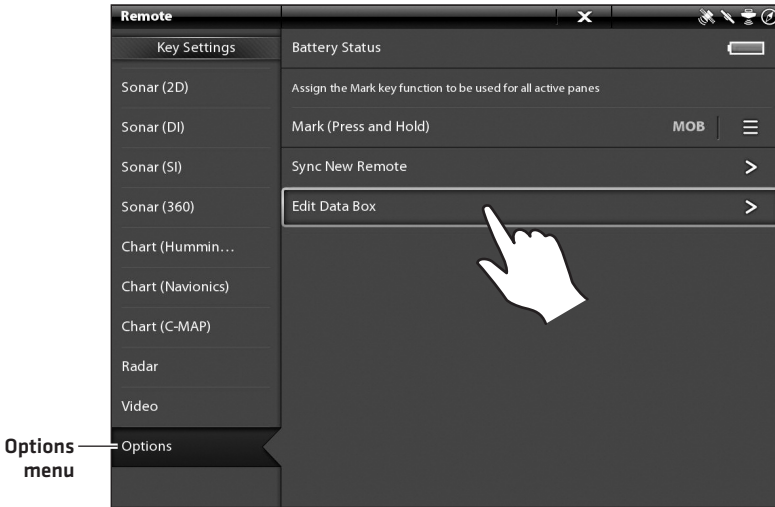

Selecting the Data Type (ONIX)

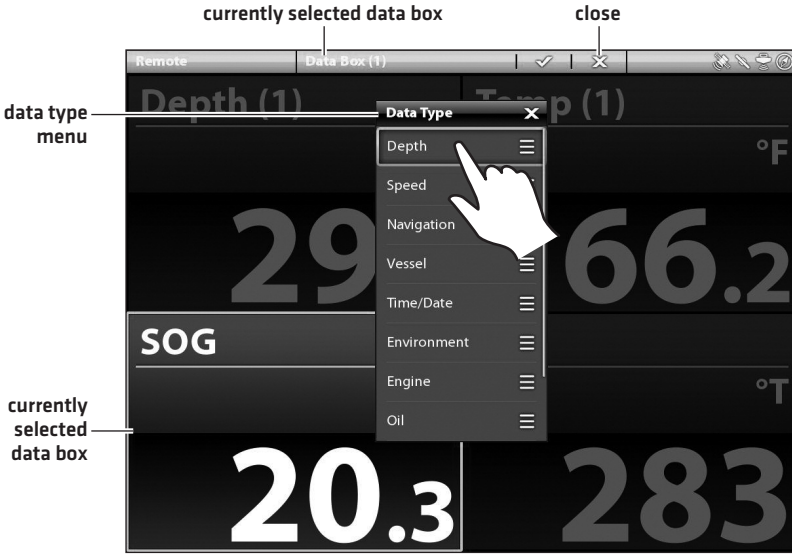

Selecting the Data Label (ONIX)

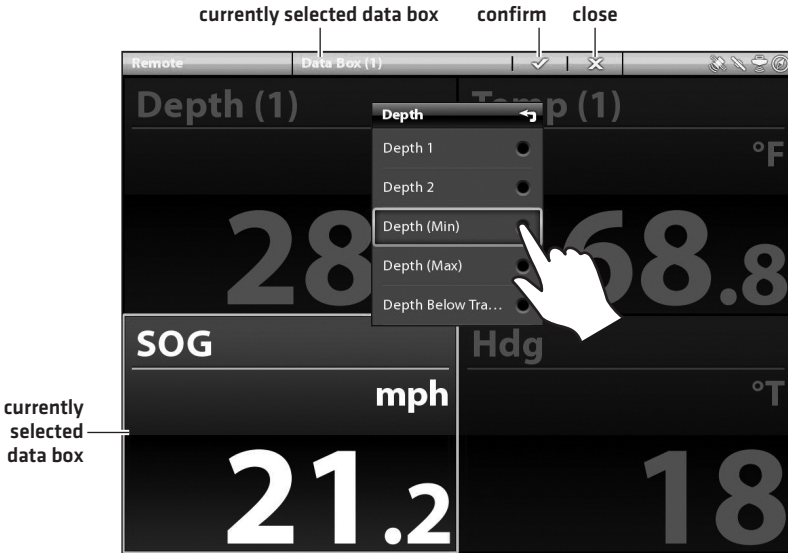

TROUBLESHOOTING

Before contacting Humminbird Customer Service, please read the following section. Taking the time to review these troubleshooting guidelines may allow you to solve a performance problem yourself, and therefore avoid sending your unit back for repair.

Control Head Doesn't Detect the Wireless Equipment

A connected and functioning wireless dongle will automatically be detected by the control head. If your control head doesn't detect the connected dongle, perform the following troubleshooting tasks:

- Check to make sure that the dongle cable is securely connected to the control head.
- Disconnect the dongle cable and reconnect it, if necessary. Power up the control head again to see if this fixes the problem.

Sync a New Wireless Remote

If you purchased a new wireless remote, use the following instructions to sync the new remote with the dongle connected to your control head.

SOLIX and ONIX

1. Open the Bluetooth tool [SOLIX] or the Wireless Remote tool [ONIX].
2. Select **Remote Options > Sync New Remote** [SOLIX] or **Options > Sync New Remote** [ONIX].
3. Follow the instructions displayed on-screen to sync the remote.

When the display box disappears, the pairing process has completed successfully.

4. To confirm the remote is synced, open the Network Info dialog box [Home > Settings > Network > Network Info]. Confirm the wireless remote is listed under This Unit [see **Getting Started: Confirm Connection on the Control Head**].

HELIX

1. Press the MENU key twice to access the Main Menu.
2. Select the Accessories Menu tab.
3. Select Wireless Remote.
4. Select **Options > Sync New Remote**.
5. Follow the instructions displayed on-screen to sync the remote.

When the display box disappears, the pairing process has completed successfully.

6. To confirm the remote is synced, open the Accessory Test View. Confirm the wireless remote is listed under Accessory Test [see **Getting Started: Confirm Connection on the Control Head**].

STATEMENTS AND ACKNOWLEDGEMENTS

ENVIRONMENTAL COMPLIANCE STATEMENT: It is the intention of Johnson Outdoors Marine Electronics, Inc. to be a responsible corporate citizen, operating in compliance with known and applicable environmental regulations, and a good neighbor in the communities where we make or sell our products.

WEEE DIRECTIVE: EU Directive 2002/96/EC “Waste of Electrical and Electronic Equipment Directive (WEEE)” impacts most distributors, sellers, and manufacturers of consumer electronics in the European Union. The WEEE Directive requires the producer of consumer electronics to take responsibility for the management of waste from their products to achieve environmentally responsible disposal during the product life cycle.

WEEE compliance may not be required in your location for electrical & electronic equipment (EEE), nor may it be required for EEE designed and intended as fixed or temporary installation in transportation vehicles such as automobiles, aircraft, and boats. In some European Union member states, these vehicles are considered outside of the scope of the Directive, and EEE for those applications can be considered excluded from the WEEE Directive requirement.



This symbol (WEEE wheeie bin) on product indicates the product must not be disposed of with other household refuse. It must be disposed of and collected for recycling and recovery of waste EEE. Johnson Outdoors Marine Electronics, Inc. will mark all EEE products in accordance with the WEEE Directive. It is our goal to comply in the collection, treatment, recovery, and environmentally sound disposal of those products; however, these requirements do vary within European Union member states. For more information about where you should dispose of your waste equipment for recycling and recovery and/or your European Union member state requirements, please contact your dealer or distributor from which your product was purchased.

ROHS STATEMENT: Product designed and intended as a fixed installation or part of a system in a vessel may be considered beyond the scope of Directive 2002/95/EC of the European Parliament and of the Council of 27 January 2003 on the restriction of the use of certain hazardous substances in electrical and electronic equipment.

FCC

Johnson Outdoors Marine Electronics, Inc

Model: AS RC

This device complies with Part 15 of the FCC Rules.

Operation is subject to the following two conditions:

1. this device may not cause harmful interference, and
2. this device must accept any interference received, including interference that may cause undesired operation.

FCC ID: 2AAHS-ASRC

IC: 4397C-ASRC

TOXIC OR HAZARDOUS SUBSTANCES OR ELEMENTS / 有毒有害物质和元素含量表



Part Name / 零件编号	Toxic or Hazardous Substances and Elements / 有毒有害物质和元素含量表	Lead (Pb) 铅	Mercury (Hg) 汞	Cadmium (Cd) 镉	Hexavalent Chromium (Cr (VI)) 六价铬	Polybrominated Biphenyls (PBB) 多溴联苯	Polybrominated Diphenyl Ethers (PBDE) 多溴二苯醚
Wireless Remote (無線遙控器)	<input type="radio"/>	<input type="radio"/>	<input type="radio"/>	<input type="radio"/>	<input type="radio"/>	<input type="radio"/>	<input type="radio"/>
Dongle (硬件鎖)	<input type="radio"/>	<input type="radio"/>	<input type="radio"/>	<input type="radio"/>	<input type="radio"/>	<input type="radio"/>	<input type="radio"/>
Lithium Cell Battery (鋰電池)	<input type="radio"/>	<input type="radio"/>	<input type="radio"/>	<input type="radio"/>	<input type="radio"/>	<input type="radio"/>	<input type="radio"/>
Lanyard (掛繩)	<input type="radio"/>	<input type="radio"/>	<input type="radio"/>	<input type="radio"/>	<input type="radio"/>	<input type="radio"/>	<input type="radio"/>
Hardware Bag (硬件包)	<input type="radio"/>	<input type="radio"/>	<input type="radio"/>	<input type="radio"/>	<input type="radio"/>	<input type="radio"/>	<input type="radio"/>

NOTE: Not all items listed in this table are included in every package. 注：每个产品包装中不一定包含此表中所列全部项目

○: Indicates that this toxic or hazardous substance contained in all of the homogeneous materials for this part is below the limit requirement in SJ/T11363-2006.

表示该有毒有害物质在该部件所有均质材料中的含量均在SJ/T11363-2006标准规定的限量要求以下

×: Indicates that this toxic or hazardous substance contained in at least one of the homogeneous materials used for this part is above the limit requirement in SJ/T11363-2006.
表示该有毒有害物质至少在該部件的某一均质材料中的含量超出SJ/T11363-2006标准规定的限量要求

1-YEAR LIMITED WARRANTY

We warrant the original retail purchaser that products made by Humminbird have been manufactured free from defects in materials and workmanship. This warranty is effective for one year from the date of original retail purchase. Humminbird products found to be defective and covered by this warranty will be repaired or replaced free of charge at Humminbird's option and returned to the customer freight prepaid. Humminbird's sole responsibility under this warranty is limited to the repair or replacement of a product that has been deemed defective by Humminbird. Humminbird is not responsible for charges connected with the removal of such product or reinstallation of replaced or repaired parts.

This warranty does not apply to a product that has been:

- Improperly installed;
- Used in an installation other than that recommended in the product installation and operation instructions;
- Damaged or has failed because of an accident or abnormal operation;
- Repaired or modified by entities other than Humminbird.

Please retain your original receipt as a proof of the purchase date. This will be required for in-warranty service.

THIS WARRANTY IS EXPRESSLY IN LIEU OF ANY OTHER WARRANTIES, OBLIGATIONS OR LIABILITIES ON THE PART OF HUMMINBIRD AND WILL BE THE CUSTOMER'S EXCLUSIVE REMEDY, EXCEPT FOR ANY APPLICABLE IMPLIED WARRANTIES UNDER STATE LAW WHICH ARE HEREBY LIMITED IN DURATION TO ONE YEAR FROM THE DATE OF ORIGINAL PURCHASE. IN NO EVENT WILL HUMMINBIRD BE LIABLE FOR ANY INCIDENTAL OR CONSEQUENTIAL DAMAGES FOR BREACH OF ANY EXPRESS OR IMPLIED WARRANTY RELATING TO THE PRODUCTS.

Some states do not allow limitations on an implied warranty, or the exclusion of incidental or consequential damages, so the above exclusions may not apply to you. You may also have other rights, which vary from state to state.

HUMMINBIRD SERVICE POLICY

Even though you'll probably never need to take advantage of our incredible service policy, it's good to know that we back our products this confidently. We do it because you deserve the best. We will make every effort to repair your unit within three business days from the receipt of your unit at our factory. This does not include shipping time to and from our factory. Units ordered on Friday are typically shipped by the following Wednesday, units received Monday are typically shipped by Thursday, etc.

All repair work is performed by factory-trained technicians to meet exacting factory specifications. Factory-serviced units go through the same rigorous testing and quality control inspections as new production units.

After the original warranty period, a standard flat rate service charge will be assessed for each repair [physical damage and missing parts are not included]. Any repairs made after the original warranty will be warranted for an additional 90 days after service has been performed by our factory technicians. You can contact Humminbird Customer Service or visit our web site to verify the flat rate repair fee for your product [visit the Product Support section]:

<http://www.humminbird.com>

We reserve the right to deem any product unserviceable when replacement parts are no longer available or impossible to obtain. This Service Policy is valid in the United States only. This applies only to Humminbird products returned to our factory in Eufaula, Alabama. This Service Policy is subject to change without notice.

DOMESTIC (USA) CUSTOMERS:

PLEASE DO NOT RETURN THIS PRODUCT TO STORE FOR SERVICE

For all technical issues please call **1-800-633-1468** or visit **humminbird.com**, click **SUPPORT**. Please reference product serial number and model number when contacting Humminbird.

RETURNING YOUR UNIT FOR SERVICE

Before sending your unit in for repair, please contact the factory, either by phone or by email, to obtain a Repair Authorization Number for your unit.



NOTE: Please do not return your Humminbird to the store for service.

Please have your product model name and serial number available before calling the factory. If you contact the factory by e-mail, please include your product model name and serial number in the e-mail, and use Request for Repair Authorization Number for your e-mail subject header. You should include your Repair Authorization Number in all subsequent communications about your unit.

For IN-WARRANTY service, complete the following steps:

- Obtain a Repair Authorization Number from Humminbird Customer Service.
- Tag product with your name, street address, phone number and your assigned Repair Authorization Number.
- Include a brief written description of the problem.
- Include a copy of your receipt [to show proof and date of purchase].
- Return product freight prepaid to Humminbird, using an insured carrier with delivery confirmation.

For OUT-OF-WARRANTY service, complete the following steps:

- Obtain a Repair Authorization Number from Humminbird Customer Service.
- Include payment in the form of credit card number and expiration date, or a money order. Please do not send cash.
- Tag product with your name, street address, phone number and your assigned Repair Authorization Number.
- Include a brief written description of the problem.
- Return product freight prepaid to Humminbird, using an insured carrier with delivery confirmation.

CONTACT HUMMINBIRD

Contact Humminbird Customer Service in any of the following ways:

Web site:

humminbird.com

E-mail:

service@humminbird.com

Telephone:

1-800-633-1468

Direct Shipping:

Humminbird
Service Department
678 Humminbird Lane
Eufaula, AL 36027 USA

Hours of Operation:

Monday - Friday

8:00 a.m. to 4:30 p.m. [Central Standard Time]

Social Media Resources:



[Facebook.com/HumminbirdElectronics](https://www.facebook.com/HumminbirdElectronics)



[Twitter.com \[@humminbirdfish\]](https://twitter.com/@humminbirdfish)



[YouTube.com/humminbirdtv](https://www.youtube.com/humminbirdtv)

