

Item / Assembly	Part #	Description	Qty.
A	2996400	HEADING SENSOR ASSEMBLY	1
1	2393400	SCREW-#8-18X1-1/2 PPH TY AB SS *STAINLESS STEEL*	2
2	✖	HEADING SENSOR	1

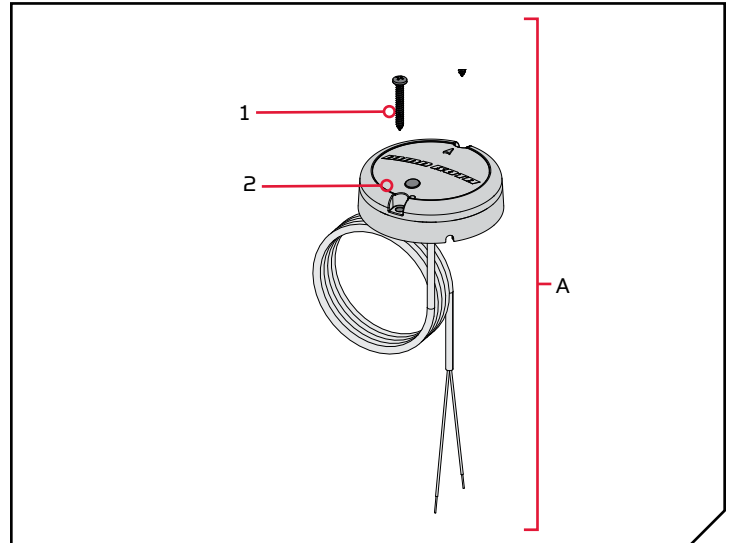

✖ This part is included in an assembly and cannot be ordered individually.

### THEORY OF OPERATION

## HEADING SENSOR FUNCTIONS

The Minn Kota Heading Sensor provides boat heading information to a Bluetooth compatible i-Pilot or i-Pilot Link equipped Minn Kota motor. It contains a compass that senses the boat's heading. The heading is used by the i-Pilot or i-Pilot Link system for navigation features such as Spot-Lock Jog. The Heading Sensor does not contain a GPS receiver and it does not change or control the orientation of the boat. The Minn Kota Heading Sensor can only communicate with other Bluetooth compatible Minn Kota products.

## ⚠ WARNING

The Heading Sensor should not be used as a navigational aid to prevent collision, grounding, boat damage, or personal injury. When the boat is moving, water depth may change too quickly to allow time for you to react. Always operate the boat at very slow speeds if you suspect shallow water or submerged objects.

Do not install the Heading Sensor near ferrous metals or near anything that may create a magnetic field or interference. The Heading Sensor must be installed at least 24" from magnetic or ferrous materials on the boat including the base of the motor. Installation near the motor lead wires must also be avoided due to magnetic fields being created during high current draw situations.

### MOUNTING CONSIDERATIONS

Before mounting your Heading Sensor, give consideration to the following:

- a. The Heading Sensor contains a compass that detects a magnetic field. Do not install the Heading Sensor near ferrous metals or wires that handle large currents, such as batteries or power cables.
- b. Mount the Heading Sensor in an area that has a clear line of communication with the head of the motor that is installed with a Bluetooth compatible i-Pilot or i-Pilot Link system for optimum performance.
- c. Make sure the area under the mounting location is level and is clear to drill holes and installation hardware will not damage existing components below the mounting surface.

## ⚠ CAUTION

The Heading Sensor can be adversely affected by magnets or large, ferrous metal objects. Do not install the Heading Sensor within 24" of these objects as they will cause interference.

- d. Test that the power cable that powers the Heading Sensor is long enough to reach the power source from the intended mounting location. If the cable does not reach the battery or intended power source, select a location closer to the source.
- e. Mount the Heading Sensor horizontally. It should not be mounted upside down.

## TOOLS AND RESOURCES REQUIRED

- Drill
- 1/4" Drill Bit
- #2 Screwdriver
- 9/64" Drill Bit
- Awl or similar marking tool
- Marine-grade Silicone

## INSTALLATION

### MOUNTING OPTIONS

There are two options to install the Heading Sensor. Determine if the power cable for the Heading Sensor will pass below the mounting surface.

1. **Access under the Mounting Location** - When installing the Heading Sensor with this option, the power cables that come from the Heading Sensor will pass through the mounting surface. Only choose this option when the cables can be accessed after they are passed through the mounting surface. Follow the instructions in the Installation for Access Under the Mounting Location section of this instruction sheet.
2. **No Access under the Mounting Location** - The power cables for the Heading Sensor will be routed to the side because there is no room under the mounting location for the cables to pass, or the area below the mounting location is not accessible. Follow the instructions in the Installation for No Access Under the Mounting Location section of this instruction sheet.

It is important to review the mounting considerations and test run the power cable before installation.

### Installation for Access Under the Mounting Location

1

#### ITEM(S) NEEDED



- a. Review the Mounting Considerations and then set the Heading Sensor (Item #2) flat on the selected mounting location and note the placement.
- b. Lift the Heading Sensor away and mark a point with an awl or similar marking tool beneath the mounting location for the power cable to pass through the surface.
- c. Using a drill with a 1/4" bit, drill a hole through the mounting location.
- d. Route the power cable through the drilled hole and feed the cable all the way through until the Heading Sensor sits flat on the mounting location and the cable is completely threaded through the drill hole.

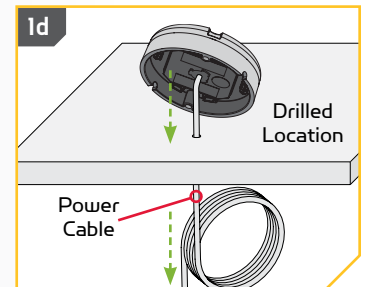
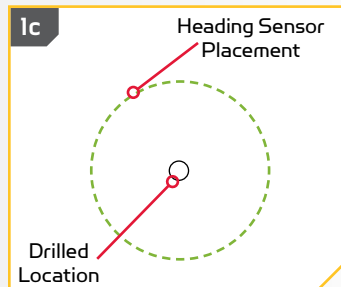
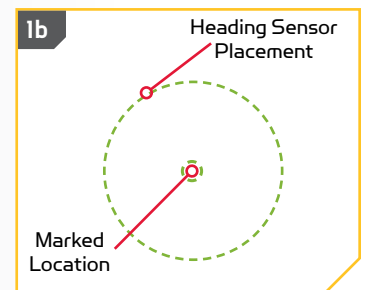
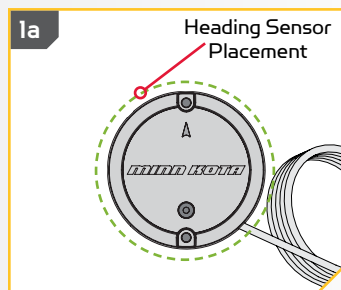

2

- e. Position the sensor so that the arrow on the cover is pointed toward the front of the boat in the direction of travel. **The arrow needs to be parallel with the keel of the boat.**



## CAUTION

Failure to align the Heading Sensor correctly will result in incorrect compass readings.

- f. Mark the location of the two screw holes with an awl or similar marking tool.

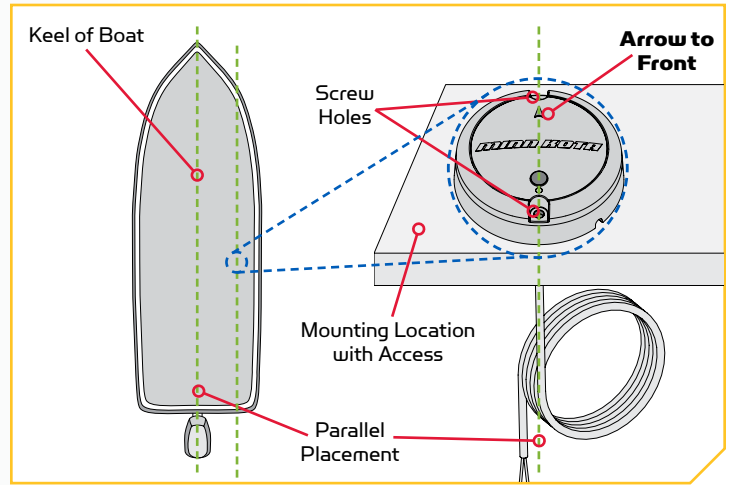

3

- g. Move the Heading Sensor to the side and drill two holes using a 9/64" drill bit on the marked locations.

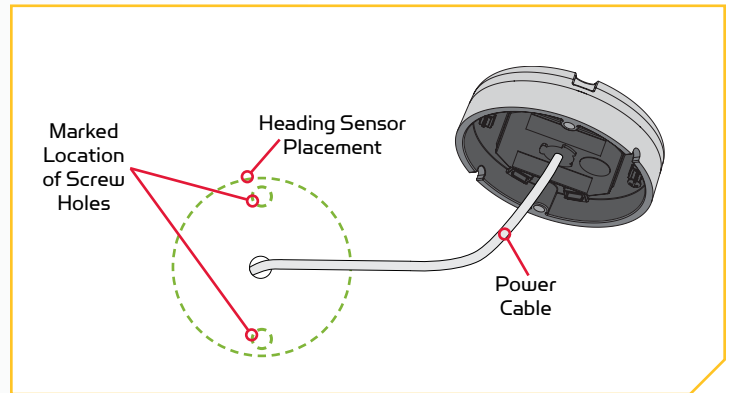

4

- h. Position the Heading Sensor back in place so that the holes drilled in the mounting location line up with the holes in the Heading Sensor and the Power Cable is completely threaded. **Be sure to mount the arrow towards the front of the boat and make the alignment parallel with the keel of the boat.**



## CAUTION

Failure to align the Heading Sensor correctly will result in incorrect compass readings.

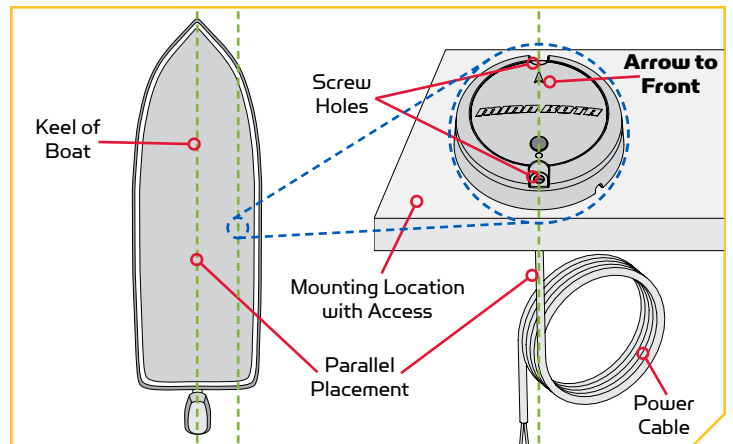

## CAUTION

If the mounting surface is thin or made of a lightweight material, the mounting surface may need to be reinforced in order to support the Heading Sensor. Hand tighten the mounting screw to avoid over tightening and to prevent damage to the mounting location and Heading Sensor.

# 5

## ITEM(S) NEEDED

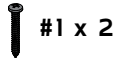

- i. Apply a marine-grade silicone caulk or sealant to both #8 - 18x1-1/2 screws (Item #1) as needed to protect your boat from water damage.
- j. Using a #2 Screwdriver, mount the Heading Sensor to the mounting location using the two screws. Hand tighten only.

**NOTE:** If replacement screws must be used, ensure that they are high grade non-magnetic stainless steel.

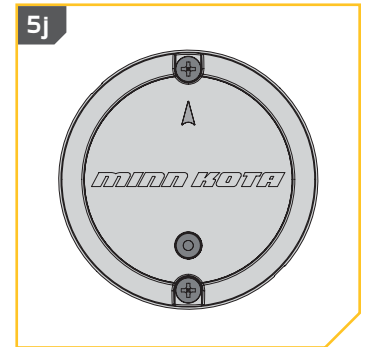
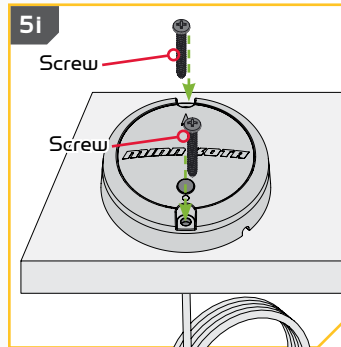

## Installation for No Access Under the Mounting Location

# 1

## ITEM(S) NEEDED



- a. Review the Mounting Considerations and then set the Heading Sensor (Item #2) flat on the mounting location and note its placement.
- b. Route the power cable through one of the two notches in the base of the Heading Sensor. When the arrow on the Heading Sensor is pointing towards the front of the boat, the cable should exit the Heading Sensor in the direction that is closest to its intended power source.

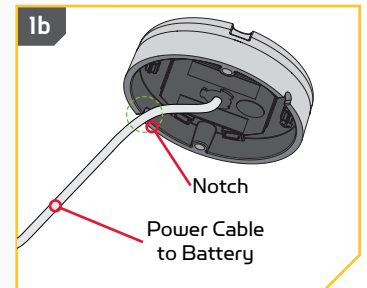
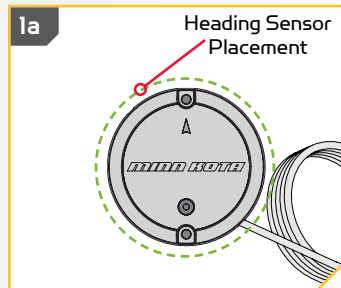

# 2

- c. Double check the position of the Heading Sensor so that the arrow on the cover is pointed toward the front of the boat in the direction of travel. **The arrow needs to be parallel with the keel of the boat.**

## CAUTION

Failure to align the Heading Sensor correctly will result in incorrect compass readings.

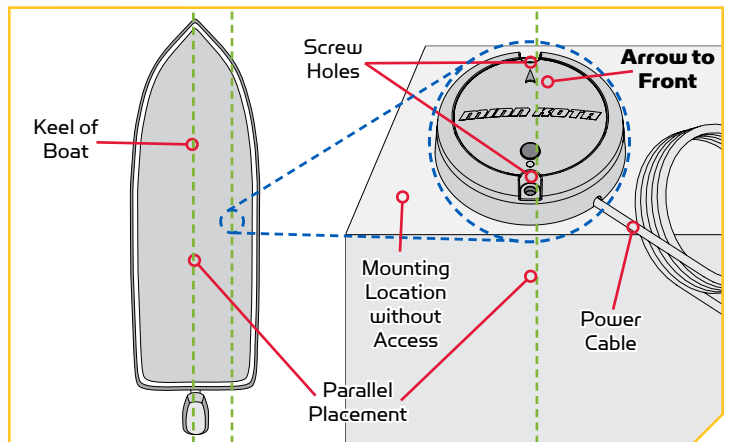

3

- d. Mark the location of the two screw holes with an awl or similar marking tool.
- e. Move the Heading Sensor to the side and drill two holes using a 9/64" drill bit on the marked locations.

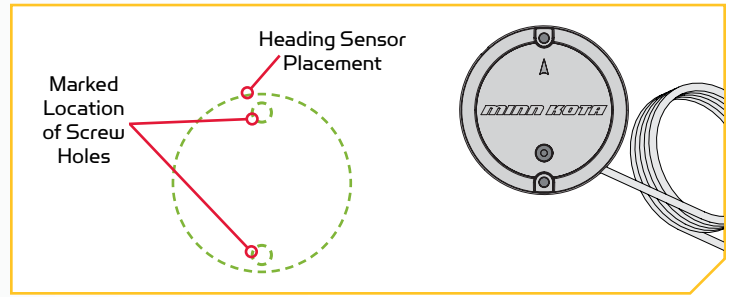

4

ITEM(S) NEEDED

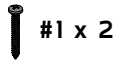

- f. Position the Heading Sensor back in place so that the holes drilled in the mounting location line up with the holes in the Heading Sensor. Be sure to mount the arrow towards the front of the boat and **make the alignment parallel with the keel of the boat.**
- g. Apply a marine-grade silicone caulk or sealant to both #8 - 18x1-1/2 screws (Item #1) as needed to protect your boat from water damage.

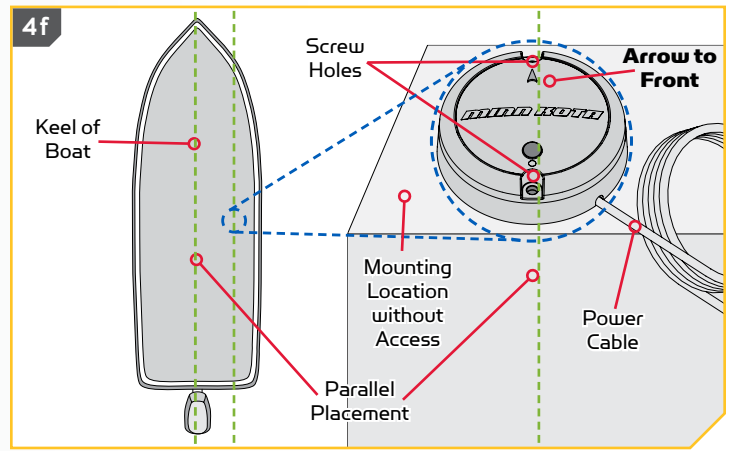

**CAUTION**

Failure to align the Heading Sensor correctly will result in incorrect compass readings.

5

- h. Using a #2 Screwdriver, mount the Heading Sensor to the mounting location using the two screws. Hand tighten only.

**CAUTION**

If the mounting surface is thin or made of a lightweight material, the mounting surface may need to be reinforced in order to support the Heading Sensor. Hand tighten the mounting screw to avoid over tightening and to prevent damage to the mounting location and Heading Sensor.

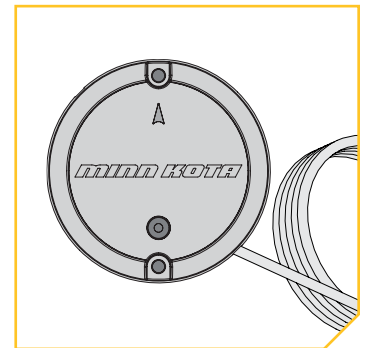
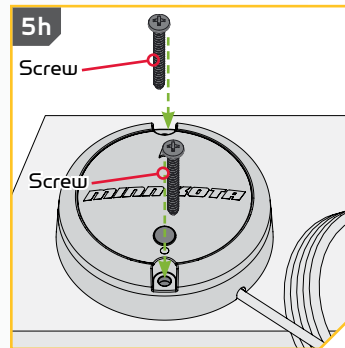

**NOTE:** If replacement screws must be used, ensure that they are high grade non-magnetic stainless steel.

## Connecting the Heading Sensor to a Power Source

The Heading Sensor is powered by 12 volts, either through a switch, or directly to the battery. To connect the Heading Sensor, please follow the directions below.

1. Connect positive (+) red lead to positive (+) power source terminal.
2. Connect negative (-) black lead to negative (-) power source terminal.

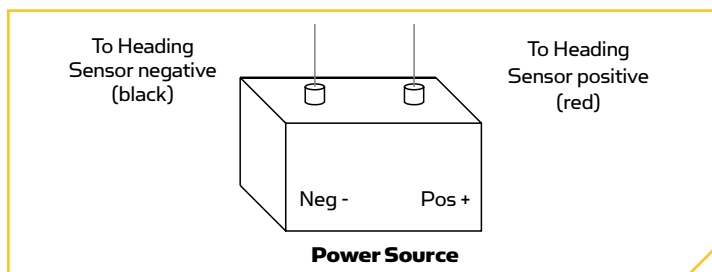

## WARNING

Never connect the (+) and the (-) terminals of the same battery together. Take care that no metal object can fall onto the battery and short the terminals. This would immediately lead to a short and extreme fire danger.

## HEADING SENSOR COMMUNICATION

### LIGHT PATTERNS

The Heading Sensor displays modes of operation with an LED located on the Pair Button. There are three distinct patterns that the LED will display to communicate different modes of operation. Become familiar with the modes of operation to be sure that the Heading Sensor is powered up and communicating with i-Pilot or i-Pilot Link.

The three LED patterns displayed by the Heading Sensor are:

1. Power On - When the Heading Sensor is first connected to a power source, the LED will turn on for 3 seconds and then turn off.
2. Pairing - The Heading Sensor can be paired with i-Pilot and i-Pilot Link. While the Heading Sensor is attempting to pair, the LED will flash on and off twice per second for up to 20 seconds. If the Heading Sensor is successfully paired, normal operation will begin. If the Heading Sensor is not paired, the LED will turn off.
3. Normal Operation - During normal operation when the Heading Sensor is connected to a power source and paired to and actively communicating with i-Pilot or i-Pilot Link, the LED on the Heading Sensor will flash on and off once every 3 seconds.

## HEADING SENSOR SET-UP

### PAIRING THE HEADING SENSOR

Before the Heading Sensor can be paired, make sure that it has been properly installed and connected to a power source. Review the LED patterns that the Heading Sensor communicates in order to understand what mode it is in and to be able to recognize that it has successfully paired once the process is complete. To pair the Heading Sensor:

- 1**
  - a. Connect the Heading Sensor to a power source. Verify that the LED on the Heading Sensor turns on for 3 seconds and then turns off.
  - b. Power on the trolling motor. Please see the trolling motor Owner's Manual for instructions on how to power up the trolling motor.
  - c. Press the Pair button on the Heading Sensor. Verify that the LED indicates it is attempting to pair.

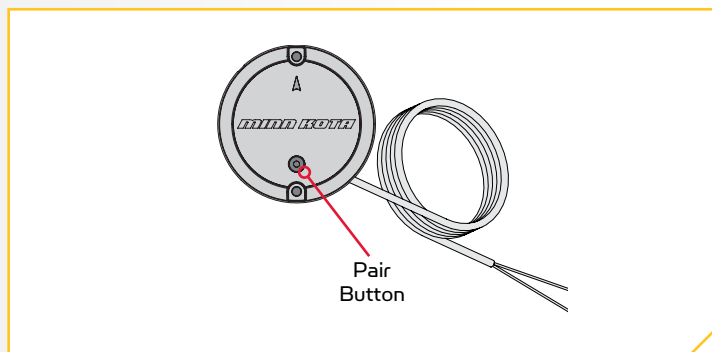

2

- d. As quickly as possible, begin to hold the Pair button on the i-Pilot or i-Pilot Link Control Head.
- e. The i-Pilot or i-Pilot Link Control Head will emit a beep pattern when the Heading Sensor is successfully paired. Release the Pair button on the Control Head. Watch the Heading Sensor to be sure that once it successfully pairs that it starts emitting the LED pattern for normal operation.
- f. After the Heading Sensor is paired with i-Pilot or i-Pilot Link, proceed to Sensor Calibration and Sensor Offset.

**NOTE:** If battery power is lost, the Heading Sensor will not lose its Pairing to the i-Pilot or i-Pilot Link system when it is powered down.

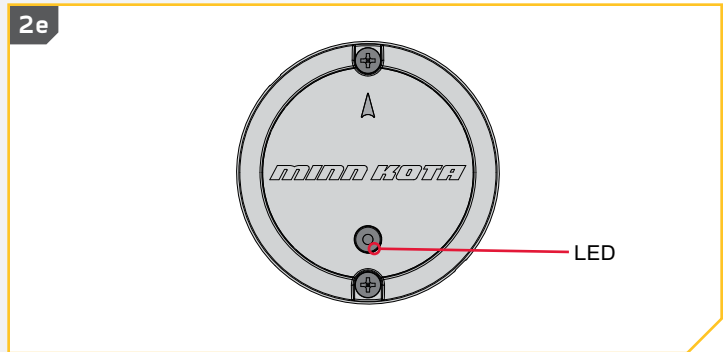
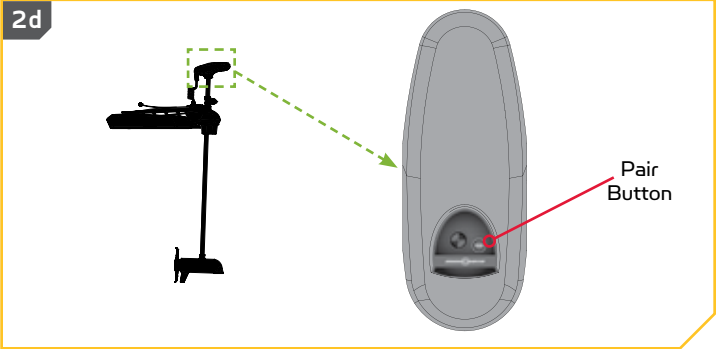

## HEADING SENSOR CALIBRATION

The Heading Sensor calibration is initiated using either the i-Pilot or i-Pilot Link remote. Refer to the Owner's Manual for your motor if you are unsure of the i-Pilot system that comes with your motor. The process of calibrating the Heading Sensor must occur while your boat is on the water. Heading Sensor Calibration should always be performed after the trolling motor and Heading Sensor have been mounted, but before the Heading Sensor Offset is performed. The Heading Sensor must be connected to power and paired with the Control Head of the trolling motor before beginning this process. The calibration process requires the boat to be driven in two complete circles, so plan accordingly when preparing for this process. To complete this process, read all safety warnings and follow the procedure below.

### **WARNING**

You are responsible for the safe and prudent operation of your vessel. We have designed your Minn Kota product to be an accurate and reliable tool that will enhance boat operation and improve your ability to catch fish. This product does not relieve you from the responsibility for safe operation of your boat. You must avoid hazards to navigation and always maintain a permanent watch so you can respond to situations as they develop. You must always be prepared to regain manual control of your boat. Learn to operate your Minn Kota product in an area free from hazards and obstacles.

### **WARNING**

Take care that neither you nor other persons approach the turning propeller too closely, neither with body parts nor with objects. The motor is powerful and may endanger or injure you or others. While the motor is running watch out for persons swimming and for floating objects. Persons whose ability to run the motor or whose reactions are impaired by alcohol, drugs, medication, or other substances are not permitted to use this motor.

# Heading Sensor Calibration for i-Pilot

1

- Review all safety warnings and then navigate your boat to an area of the water that is free from obstructions.
- Power up the trolling motor according to the instructions provided in the Owner's Manual. Make sure the Heading Sensor is also powered up and paired with the trolling motor.
- Turn on the remote for your i-Pilot system.

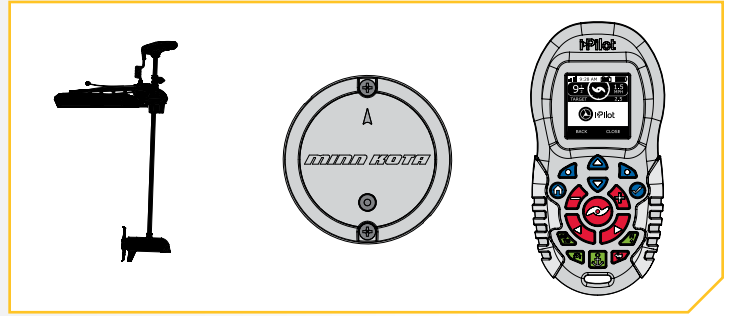

2

- On the i-Pilot remote, use the Menu Up and Menu Down buttons to find the System menu at the bottom of the display screen.
- Use the Right Softkey to select the System menu.
- Use the Menu Up and Menu Down buttons to find the Sensor Cal menu at the bottom of the display screen. Use the Ok button to select it.
- The Sensor Cal screen will display.

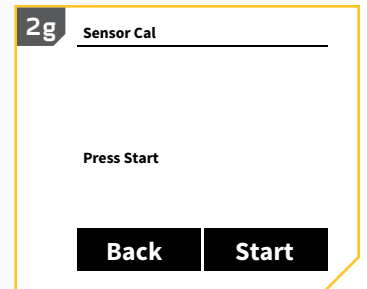
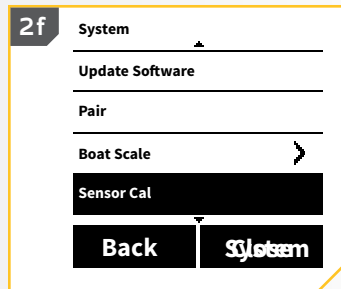
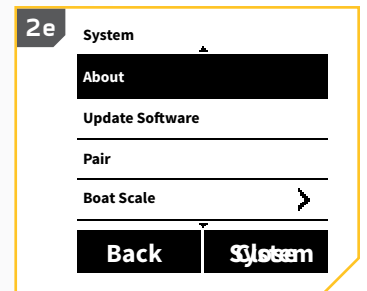
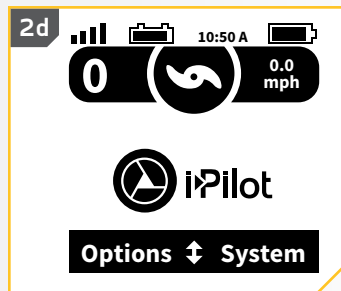

3

- Use the Right Softkey to select the Start menu.
- Review all safety warnings and then follow the prompts on the display screen and drive the boat in two complete circles.
- The left side of the Display Screen contains a counter that shows the number of complete turns that the boat has been driven and will increase from 0 to 1 and 2 as the circles are complete.
- The Circle on the right side of the display screen will show how complete the boat has progressed through the current circle and will fill in like a pie chart as the boat progresses.
- Once the two complete circles have been completed, the display screen will read Cal Successful.
- Use the Right Softkey to select the Close menu.

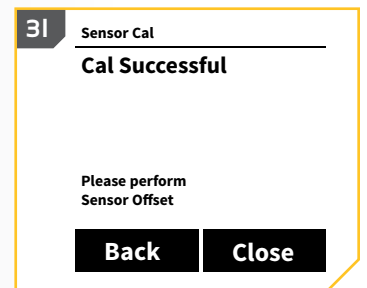
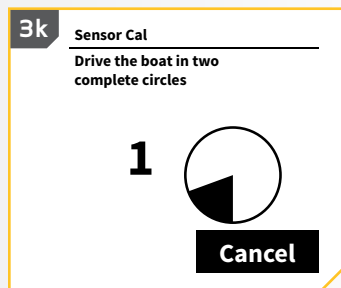
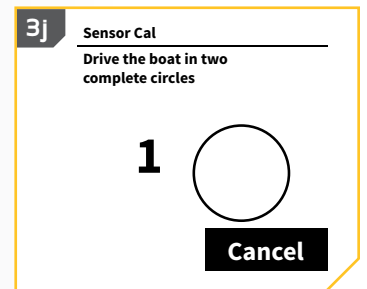
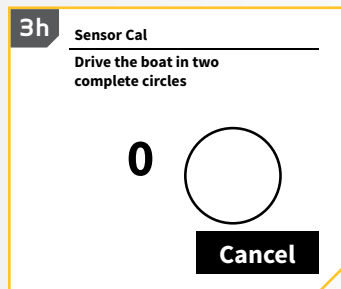



# Heading Sensor Calibration for i-Pilot Link

1

- a. Review all safety warnings and then navigate your boat to an area of the water that is free from obstructions.
- b. Power up the trolling motor according to the instructions provided in the Owner's Manual. Make sure the Heading Sensor is also powered up and paired with the trolling motor.
- c. Turn on the remote for your i-Pilot or i-Pilot Link system.

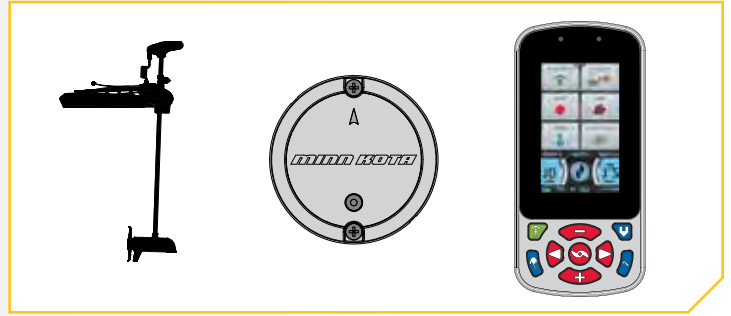

2



- d. On the i-Pilot Link remote, press the Home button.
- e. Scroll through the Content Area using either your finger or the Screen Navigation button to find the System button.
- f. Select the System button using either your finger or by pressing the Ok button to open the System Menu.

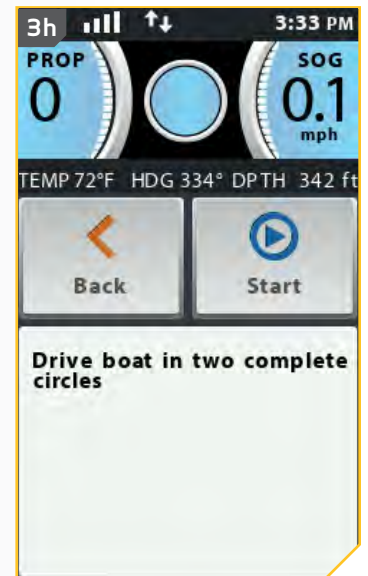

3

- g. Once in the System Menu, scroll through to find the Sensor Cal option, and select it.
- h. The Sensor Cal options appear. In order to complete sensor calibration, the boat must drive in two complete circles.
- i. Review all safety warnings and then follow the prompts on the display screen and drive the boat in two complete circles. Follow the on-screen prompt and select the Start button.



- j. The Circle on the right side of the display screen will show how the boat has progressed through the current circle and will fill in like a pie chart as the boat progresses.
- k. The left side of the Display Screen contains a counter that shows the number of complete circles that the boat has been driven and will increase from 0 to 1 and 2 as the circles are complete.
- l. Once the two complete circles have been completed, the display screen will read Cal Successful. To exit the menu, select either the Back  button or the Home  button.

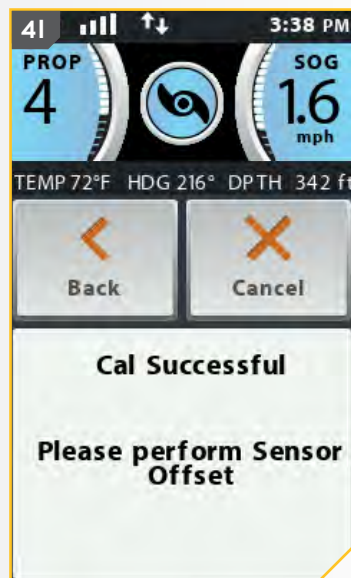
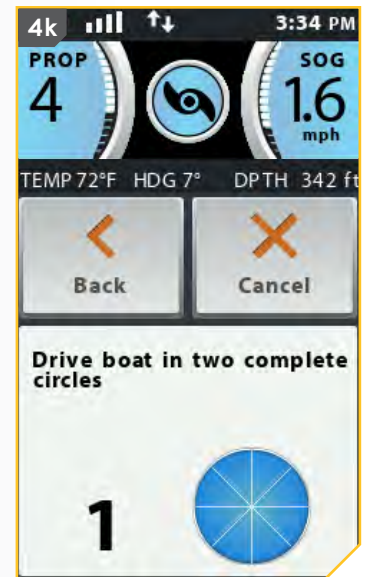
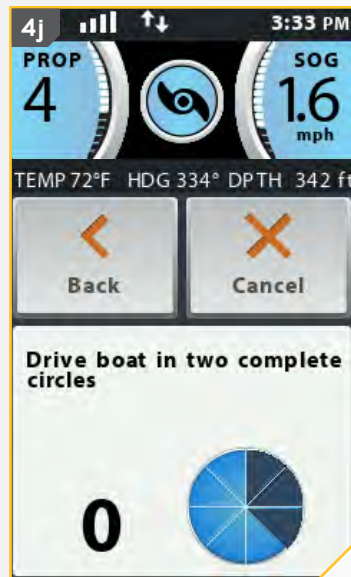







## HEADING OFFSET

Once the Heading Sensor is calibrated, the Heading Offset needs to be set. Heading Offset is the difference between the angle of the Keel of the boat and the angle that the Heading Sensor is mounted to the deck of the boat. During installation, the Heading Sensor was installed to be as parallel to the Keel of the boat as possible. If the boat and Heading Sensor are perfectly parallel and pointing in exactly the same direction, the Offset will be a perfect 0° degrees. Knowing that installations are never perfect, the Heading Offset can be set on the i-Pilot or i-Pilot Link remote to compensate for the difference between the two. Heading Offset has the ability to correct the difference in measurement in a range between +30° and -30° degrees.



## Heading Offset for i-Pilot

1

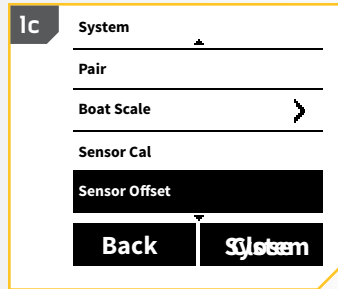
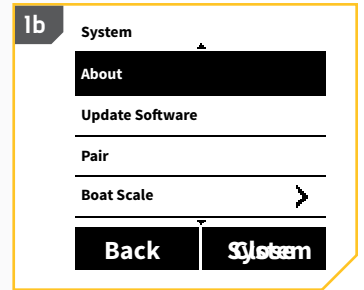
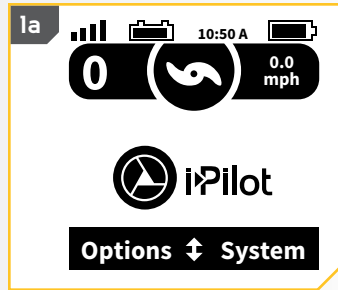
- On the i-Pilot remote, use the Menu Up  and Menu Down  buttons to find the System menu at the bottom of the display screen.
- Use the Right Softkey  to select the System menu.
- Use the Menu Up  and Menu Down  buttons to find the Sensor Offset menu at the bottom of the display screen. Use the Ok  button to select it.





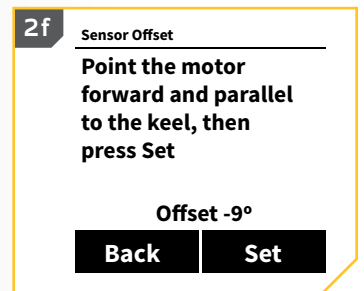
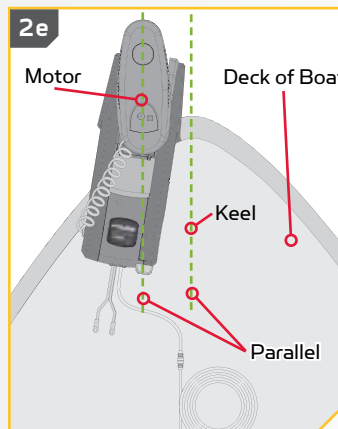

2

- The Sensor Offset screen will display.
- Turn the motor so that it is parallel with the Keel of the boat.
- Use the Right Softkey  to select the Set menu.
- The Sensor Offset will automatically adjust. Use the Left Softkey  to select Back, or press the Home  button to exit the menu.



## Heading Offset for i-Pilot Link

1

- On the i-Pilot Link remote, press the Home  button.
- Scroll through the Content Area using either your finger or the Screen Navigation  button to find the System  button.
- Select the System  button using either your finger or by pressing the Ok  button to open the System Menu.



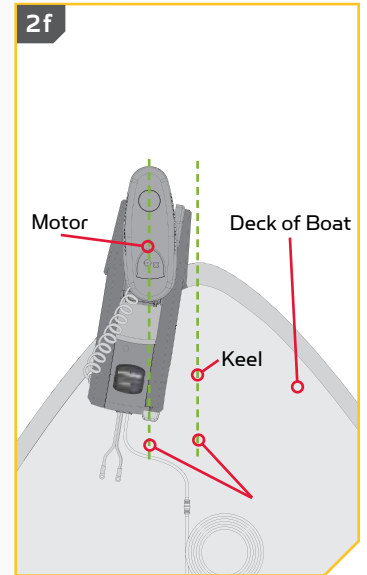

2

- d. Once in the System Menu, scroll through to find the Sensor Offset  option, and select it.
- e. The Sensor Offset options appear.
- f. Follow the on-screen prompts. Turn the motor so that it is pointing forward and parallel with the Keel of the boat.
- g. If the current Offset is greater than the allowable range, the Offset cannot be recorded.



3

- h. Once they are parallel, select the Set  button. Once set, the Offset on the bottom right of the Display Screen will update. The Sensor Offset will automatically adjust. In the event of an error, correct the Offset to fit within the tolerance allowed.
- i. Press the Home  button to exit the menu.

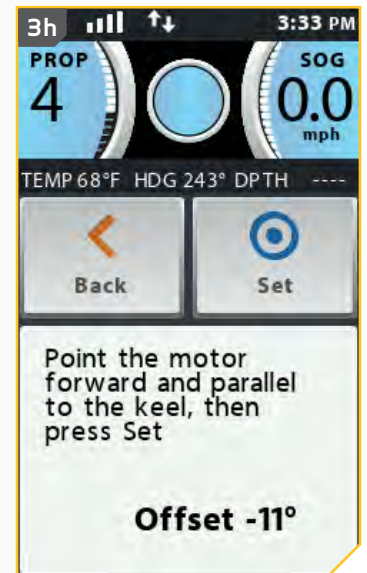

The Bluetooth® word mark and logos are registered trademarks owned by Bluetooth SIG, Inc. and any use of such marks by Johnson Outdoors, Inc. is under license. Other trademarks and trade names are those of their respective owners.

For warranty information please visit [minnkotamotors.com](http://minnkotamotors.com)

WARNING: This product contains chemicals known to the State of California to cause cancer and birth defects or other reproductive harm.



[minnkotamotors.com](http://minnkotamotors.com)

Minn Kota Consumer & Technical Service  
 Johnson Outdoors Marine Electronics, Inc.  
 PO Box 8129  
 Mankato, MN 56001

121 Power Drive  
 Mankato, MN 56001  
 Phone (800) 227-6433  
 Fax (800) 527-4464



©2017 Johnson Outdoors Marine Electronics, Inc.  
 All rights reserved.