



STYLE MAR14/MAR10/MAR8 OMNI-DIRECTIONAL MARINE TV/FM ANTENNA

Congratulations! You have chosen the Shakespeare Style MAR14, MAR10, or MAR8, omnidirectional TV/FM antenna which brings the comfort of home onto the water anywhere.

By carefully following the installation and connection instructions, you will receive years of superior performance from your new Shakespeare antenna.

Special Note: Please familiarize yourself with the assembly and installation of the MAR14/MAR10/MAR8 by reading all the way through the instructions before you begin actual installation.

PARTS LIST

- 1 MAR14/MAR10/MAR8 Antenna
- 1 75Ohm RG59 cable × 2 Connectors
- 1 1.5m Adapt Cable – fitted with F plug to TV
- 1 DC wire
- 1 Power Supply (12V & 24V)
- 1 IEC-F connector boot
- 2 Power Adapter
- 2 Screws

WARNING!
TO PREVENT FIRE OR SHOCK HAZARD, DO NOT EXPOSE POWER SUPPLY SECTION OF THIS APPLIANCE TO RAIN OR MOISTURE.

ANTENNA MOUNTING INSTRUCTIONS

Step 1

Mount antenna on a marine extension mast, standard 1"-14 thread marine antenna mount or sailboat mounting bracket as illustrated below.

CAUTION

When attaching the antenna to the antenna mount, be very careful to start threads properly before screwing antenna into position. If antenna mounting socket and antenna mount are not aligned correctly, the antenna mounting socket threads will become crossed and eventually strip out.

Figure 1

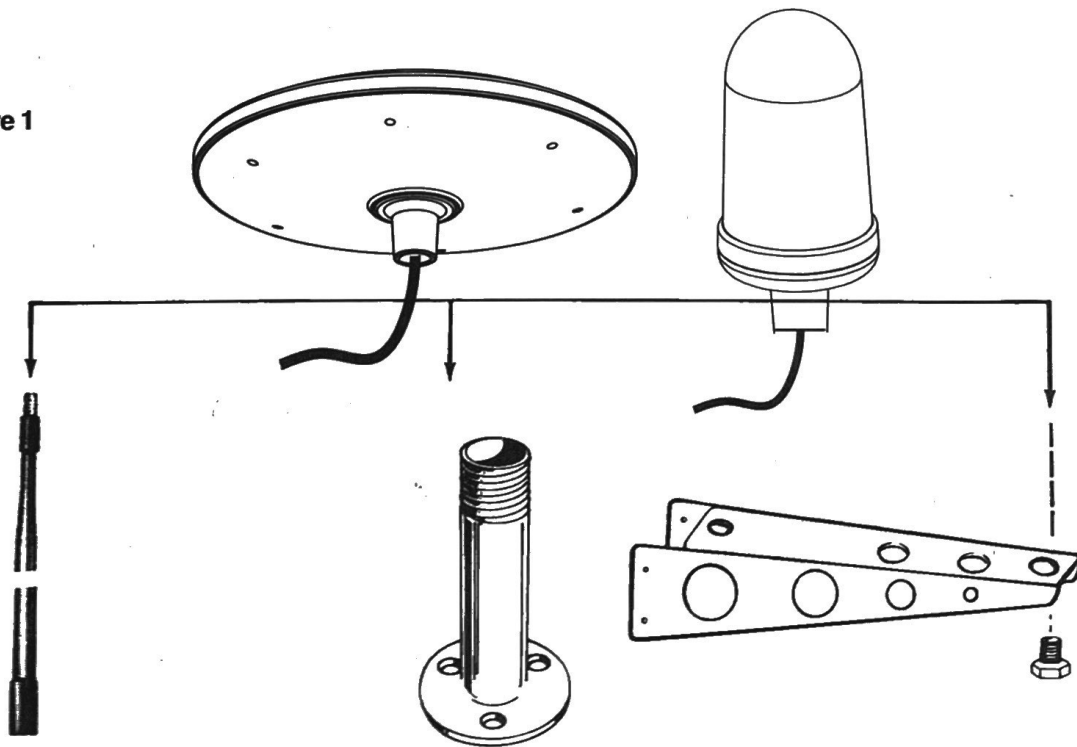

4008 MARINE EXTENDER

4365 STRAIGHT MOUNT

4366 SAILBOAT MOUNTING BRACKET
SOME MODIFICATION MAY BE NEEDED

Step 2

In a convenient location, mount the two #6 screws vertically 3-1/4" apart leaving the screw heads approximately 1/8" from wall. Hang power supply onto screws.

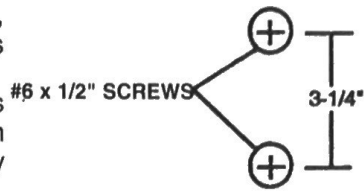

Step 3

Route the RG-59 cable from the antenna to this power supply. Allowing enough cable slack for later installation of "F" connectors, cut the cable. Route the remaining piece of RG-59 from the power supply to the back of the TV.

Figure 3

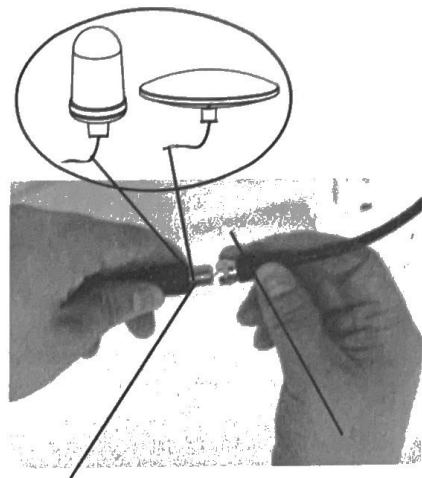

Connect Female F connector to Male F connector

Step 4

To install F-connectors strip cable jacket. See Figure 2A.

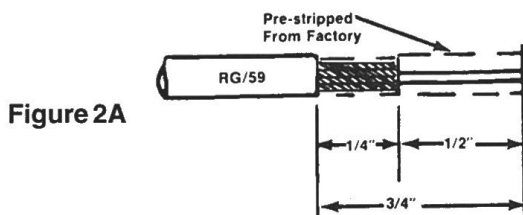

Figure 2A

Push back and twist the braid around the Dielectric until it butts against the cable jacket. Figure 2B.

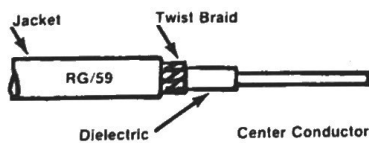

Figure 2B

Screw the F-connector onto the cable jacket until the Dielectric butts against the inner retaining ring. Cut the center conductor off flush with the end of the connector. See Figure 2C.

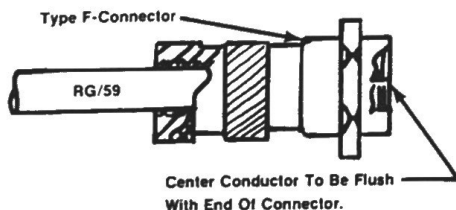

Figure 2C

Repeat this step to install all four type F-connectors.

Special Note: Place boot on cable before installing F-connector at the antenna.

Step 5

Connect power supply kits.

Connect the cable from antenna to power adapter. Connect the output connector of the power supply unit to DTV receivers or TVs. Connect the AC/DC adapter to the 12V DC jack on the power supply unit and plug the adapter into the power socket. Adjust the gain in power supply unit for best signal reception.

See Figure 4.

Figure 4

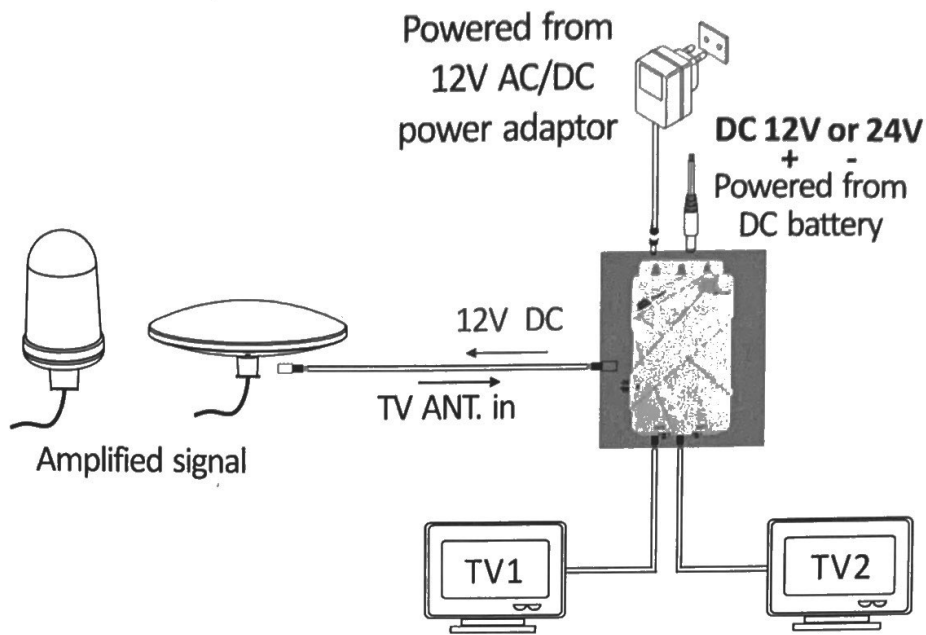

RECOMMENDATIONS FOR INSTALLING

Minimum Bending Radius: 3" for RG-59. Tighter bends will cause shorts and change impedance.

Pulling Tension: 75 pounds maximum. Leave no tension on cable after it is installed.

Staples or Clamps: The use of flat staples with coax cable is damaging to the cable. Only round headed staples can be used. Any clamps or securing devices used with coax should grip the cable evenly about the circumference without crushing the cable.

Exposure to High Heat: Maximum temperature limit is 80°C (176°F). Keep cable away from heating vents, engine compartments and engine exhaust pipes.

Crushing: Coax should not be installed in a manner that would allow it to be crushed and it should not be stuffed or wedged into areas where the cable could be pinched by the flexing of the boat hull/cabin.

OPTIONAL ACCESSORIES AVAILABLE

4366

Sailboat Mast Mount
Aluminum sailboat mast mount for the MAR14/MAR10/MAR8 Marine TV Antennas.

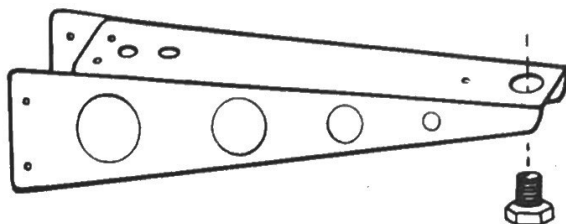

SOME MODIFICATION MAY BE NEEDED

4364-B

Extension Mast
One inch diameter extension mast for light to moderate duty applications. White molded polycarbonate male upper and female lower 1" - 14 threads.



4358

FM Take-off

Designed to provide FM radio signals from TV antenna. The 4358 may be attached anywhere in the downlead cable and will not interfere with regular TV reception. FM radio signals are available at a standard female Motorola jack on the take-off.

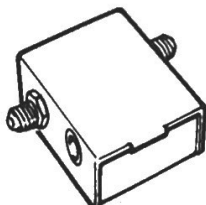

4365

Straight Mount

4" high 1"-14 thread stainless steel mount. Perfect for radar arches. May be used with Style 4364 one foot extension mast.

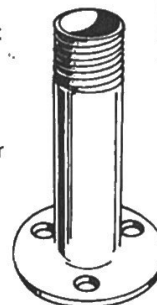

TV-1060

Screw-on "F" type Connector for RG-59 Cable.

No soldering or crimping required. Two per pack.



4711

Nylon Mount
1"2" nylon mount. Low profile.

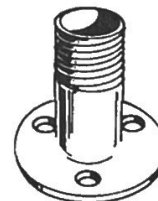

 **ANYWHERE**
by Shakespeare

Shakespeare Electronic Products Group
6111 Shakespeare Rd., Columbia, SC 29223
Tel:803-227-1590 Fax:803-419-3099