

SOLIX

Operations Manual

532566-1EN_A





SIMPLY. CLEARLY. BETTER.

THANK YOU!

Thank you for choosing Humminbird®, the #1 name in marine electronics. Humminbird has built its reputation by designing and manufacturing top quality, thoroughly reliable marine equipment. Your Humminbird is designed for trouble-free use in even the harshest marine environment. In the unlikely event that your Humminbird does require repairs, we offer an exclusive Service Policy. For complete details, see the separate warranty card included with your unit. We encourage you to read this operations manual carefully in order to get the full benefit from all the features and applications of your Humminbird product.

Contact Humminbird Customer Service at humminbird.com or call 1-800-633-1468.

 **WARNING!** This device should not be used as a navigational aid to prevent collision, grounding, boat damage, or personal injury. When the boat is moving, water depth may change too quickly to allow time for you to react. Always operate the boat at very slow speeds if you suspect shallow water or submerged objects.

 **WARNING!** The electronic chart in your Humminbird unit is an aid to navigation designed to facilitate the use of authorized government charts, not to replace them. Only official government charts and notices to mariners contain all of the current information needed for the safety of navigation, and the captain is responsible for their prudent use.

 **WARNING!** Compass Safe Distance: The control head must be installed at least 4 feet [1.2 meters] from the compass or other magnetic equipment on the boat. Also, see your compass installation guide for details.

 **WARNING!** This device is granted for use in Mobile only configurations in which the antennas used for this transmitter must be installed to provide a separation distance of at least 8 inches [20 cm] from all person and not be co-located with any other transmitters except in accordance with FCC and Industry Canada multi-transmitter product procedures.

 **WARNING!** Humminbird is not responsible for the loss of data files [waypoints, routes, tracks, groups, recordings, etc.] that may occur due to direct or indirect damage to the unit's hardware or software. It is important to back up your control head's data files periodically. Data files should also be saved to your PC before restoring the unit's defaults or updating the software. Review the information in this manual for details.

 **WARNING!** Disassembly and repair of this electronic unit should only be performed by authorized service personnel. Any modification of the serial number or attempt to repair the original equipment or accessories by unauthorized individuals will void the warranty.

 **WARNING!** This product contains chemicals known to the State of California to cause cancer and birth defects or other reproductive harm.

 **WARNING!** Do not travel at high speed with the unit cover installed. Remove the unit cover before traveling at speeds above 20 mph.

 **NOTE:** Some features discussed in this manual require a separate purchase, and some features are only available on international models. Every effort has been made to clearly identify those features. Please read the manual carefully in order to understand the full capabilities of your model.

 **NOTE:** The illustrations in this manual may not look the same as your product, but your unit will function in a similar way.

 **NOTE:** To purchase accessories or any additional equipment for your control head configuration, visit our Web site at humminbird.com or contact Humminbird Customer Service at 1-800-633-1468.

 **NOTE:** The procedures and features described in this manual are subject to change without notice. This manual was written in English and may have been translated to another language. Humminbird is not responsible for incorrect translations or discrepancies between documents.

 **NOTE:** Product specifications and features are subject to change without notice.

 **NOTE:** Humminbird verifies maximum stated depth in saltwater conditions, however actual depth performance may vary due to transducer installation, water type, thermal layers, bottom composition, and slope.

ROHS STATEMENT: Product designed and intended as a fixed installation or part of a system in a vessel may be considered beyond the scope of Directive 2002/95/EC of the European Parliament and of the Council of 27 January 2003 on the restriction of the use of certain hazardous substances in electrical and electronic equipment.

ATTENTION INTERNATIONAL CUSTOMERS: Products sold in the U.S. are not intended for use in the international market. Humminbird international units provide international features and are designed to meet country and regional regulations. Languages, maps, time zones, units of measurement, and warranty are examples of features that are customized for Humminbird international units purchased through our authorized international distributors.

To obtain a list of authorized international distributors, please visit our Web site at humminbird.com or contact Humminbird Customer Service at **[334] 687-6613**.

360 Imaging®, AUTOCHART®, AutoChart LIVE™, ChartSelect®, Cross Touch®, Down Imaging®, DualBeam PLUS™, Fish ID+™, Humminbird®, i-Pilot® Link™, LakeMaster®, MEGA Down Imaging™, MEGA Imaging™, MEGA Side Imaging™, Real Time Sonar™, RTS Window™, SI™, Side Imaging®, SmartStrike™, SOLIX™, Structure ID™, SwitchFire®, WhiteLine™, X-Press™ Menu, and ZeroLine Map Card™ are trademarked by or registered trademarks of Johnson Outdoors Marine Electronics, Inc.

Airmar is a registered trademark of Airmar Technology Corp.

Adobe, Acrobat, Adobe PDF, and Reader are either registered trademarks or trademarks of Adobe Systems Incorporated in the United States and/or other countries.

Baekmuk Batang, Baekmuk Dotum, Baekmuk Gulim, and Baekmuk Headline are registered trademarks owned by Kim Jeong-Hwan.

The Bluetooth® word mark and logos are registered trademarks owned by the Bluetooth SIG, Inc. and any use of such marks by Johnson Outdoors, Inc. is under license. Other trademarks and trade names are those of their respective owners.

Gentoo™ is a trademark of Gentoo Foundation, Inc.

Navionics® is a registered trademark of Navionics S.p.A.



NMEA 2000® is a registered trademark of the National Marine Electronics Association.

TABLE OF CONTENTS

Warnings	2	Manage your Navigation Data	92
Introduction	6	Manage Waypoints	93
Getting Started	8	Manage Routes	96
Touch Screen Overview	14	Manage Tracks	98
SOLIX Touch Screen and Keypad	15	Manage Groups	101
SOLIX Control Head	17	Delete All Navigation Data	102
SD Card Slots	19	Import/Export Navigation Data	102
The Home Screen	20	AutoChart LIVE Overview	103
The Menu System	25	Plan your Map	103
Views	32	Prepare the Control Head for Mapping	104
Edit the On-Screen View	36	Record your Custom Map	107
The View Options Menu	41	Stop Recording	108
Create a New View	43	Correct Data	109
Set up an Instrument View	47	Display the AutoChart Live Map	110
Chart Overview	49	Adjust the Map Display Settings	112
Map Source	50	Customize the Bottom Hardness Display Settings	116
Navigation Alarms Overview	55	Customize the Vegetation Display Settings	119
Man Overboard (MOB)	59	Mosaic Live Overview	122
Customize the Chart View	60	For Best Performance	122
Open the Humminbird Settings Menu	60	Open the Mosaic Live Menu	122
Change the Chart View Overlays	65	Customize the Mosaic Live Display	124
Chart and Radar	66	Autopilot Overview	128
Change the Chart Mode	67	Radar Overview	130
Introduction to Navigation	68	Radar Transmission Settings	131
Navigation Menu Overview	69	Adjust the Transmission Range	134
Navigation X-Press Menu	69	Radar Alarms	135
Mark Menu	70	Customize the Radar View	138
Go To Menu	70	Open the Radar Preferences Menu	138
Info Menu	72	Change the Radar View Overlays	140
Cursor Menu	74	Adjust Radar Signal Settings	142
Waypoints	75	EBL/VRM	144
Routes	80	Navigation in Radar View	146
Search	87	AIS and MARPA	148
Tracks	89	AIS and MARPA Alarms	148
		AIS and MARPA Display Settings	150
		AIS Overview	152
		MARPA Targets	159

TABLE OF CONTENTS

Sonar Overview	164
Sonar Setup	166
Sonar Alarms	167
2D Sonar Overview	168
Customize the 2D Sonar View	169
Open the 2D Sonar Preferences Menu	169
Change the 2D Sonar View Overlays	174
Adjust 2D Sonar Display Settings	175
Side Imaging Overview	180
Customize the Side Imaging View	182
Open the Side Imaging Preferences Menu	182
Change the Side Imaging View Overlays	184
Adjust Side Imaging Display Settings	185
Down Imaging Overview	188
Customize the Down Imaging View	189
Open the Down Imaging Preferences Menu	189
Change the Down Imaging View Overlays	191
Adjust Down Imaging Display Settings	192
Use Cursor and Zoom in Sonar Views (2D, SI, DI)	195
Navigation in Sonar Views (2D, SI, DI)	197
Sonar Recording	199
Images Tool	200
Installation Information	206
Set up or Change Transducer Settings (optional)	207
Configure Humminbird Radar (Installation and Repair only) ..	214
Configure the Control Head	218
Set up a NMEA 2000 Network	222
Set up your Humminbird Network	231
Change the Network Name	237
Manage your Control Head	239
Update Software	241
Specifications	245
Statements and Acknowledgements	250
Contact Humminbird	256

INTRODUCTION

The instructions in this manual describe the SOLIX control head operations. SOLIX models provide multi-gesture touch screen and keypad capability to adjust menu settings or start actions on the control head. Touch screen and keypad instructions are described for each feature throughout this manual. Also, for an overview of functions, see the Quick Start Guide included with your product.

Build your Network: Some of the features shown in this manual require a separate purchase. Radar, AIS, Compass/Heading Sensor, Black Box Sonar, Ethernet Switch, i-Pilot Link, etc. require a separate purchase. To install each accessory, use the installation guide provided with it, or download the guide from our Web site at humminbird.com.

Register and Update: As you build your Humminbird network, it is important to register your products and keep your software up to date. Visit our Web site at humminbird.com to set up an account, update control head and accessory software, and purchase additional equipment. Also, see *Update Software* in this manual for more information.

USING HUMMINBIRD MANUALS ON YOUR MOBILE DEVICE OR PC

The Humminbird manuals for your control head and accessories can be downloaded to your mobile device or PC. If you prefer to use a hard copy for reference, this manual may be printed.

Download the Manual to your Mobile Device

1. Download the free Adobe Acrobat Reader app to your mobile device.
2. Go to our Web site at humminbird.com, and click Support > Product Manuals.
3. Select the PDF for your control head model or accessory, and save it to your device.
4. Open the Adobe Acrobat Reader app.
5. Open the Humminbird manual.

Download the Manual to your PC

1. Download the free Adobe Acrobat Reader software from <http://get.adobe.com/reader/>, and install it on your PC.
2. Go to our Web site at humminbird.com, and click Support > Product Manuals.
3. Select the PDF for your control head model or accessory, and save it to your device.
4. Open Adobe Acrobat Reader.
5. Open the Humminbird manual.

Jump to a Section: Click a section name in the Bookmarks panel. Bookmarks can be expanded and collapsed by clicking on the plus [+] or minus [-] icons.

Search for Words or Phrases: Press and hold the Ctrl F keys on your PC keyboard. Type the word[s] into the text box.

Print: If you prefer to use a hard copy for reference, this manual may be printed.

Using the Manual

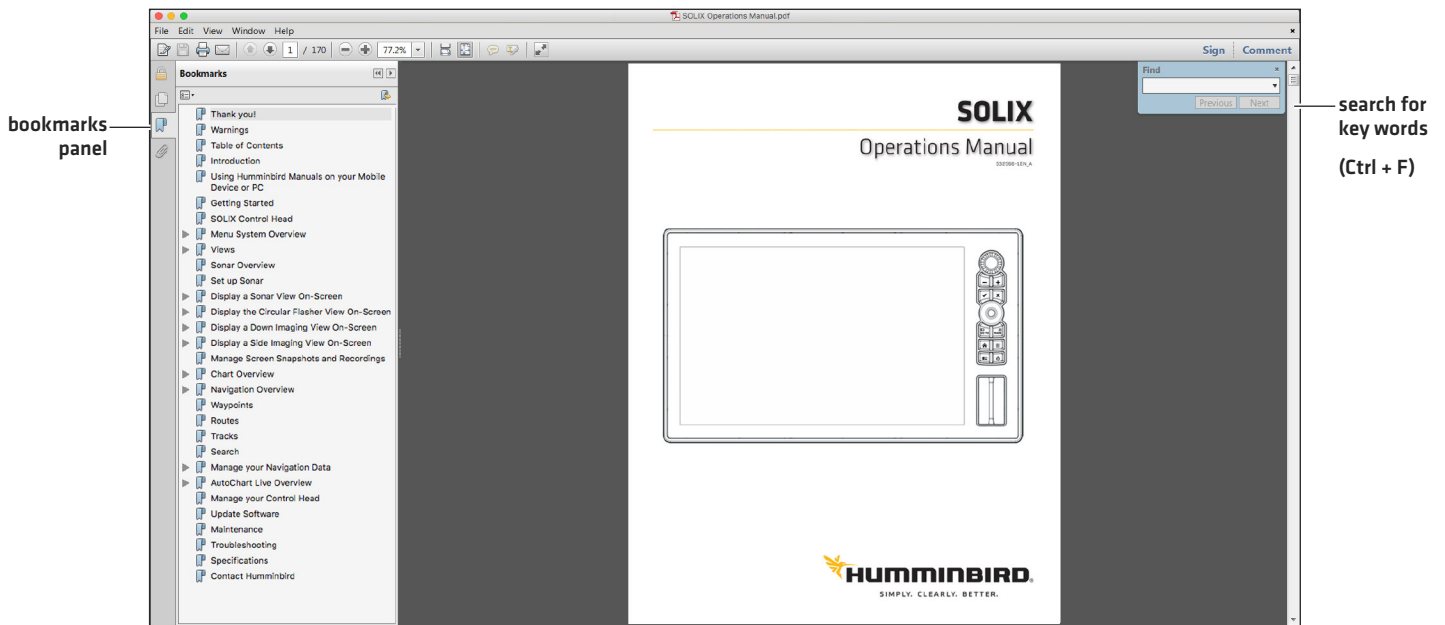

GETTING STARTED

The procedures in this section describe how to get started with your control head. See your control head installation guide to configure the unit for first time setup. Also, see **Installation Information** in this manual for control head configuration and network configuration details.

 **NOTE:** When the SOLIX control head equipment and accessories are first installed, the Setup Guide provides the prompts to guide you through configuring the unit. The Setup Guide includes important steps to configure the control head with the equipment, including vessel dimensions, map source selection, and offset menus. See your control head installation guide to configure the unit for the first time.

Power On

1. Press the POWER key.
2. Select Start Normal Mode.
3. When the first view is displayed on the screen, the control head is ready for operation.

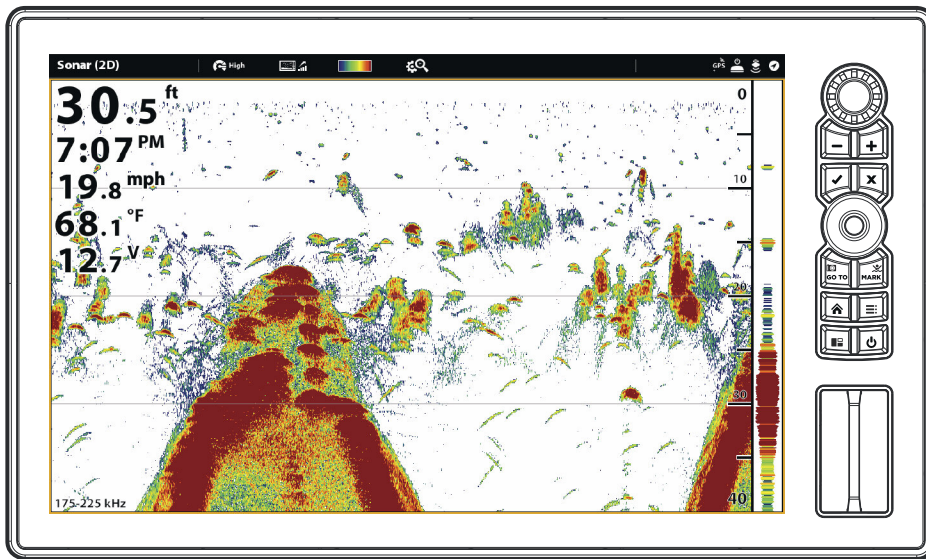

Start Radar Transmission

If a Radar is connected to the control head network, use the following instructions to start radar transmission.

 **WARNING!** The radar should be configured by a qualified radar technician after installation or equipment repair. See **Installation Information: Configure Humminbird Radar**.

1. Confirm the radar power source is turned on [breaker or switch].
2. Press the POWER key.
3. **Humminbird CHIRP Radar:** Under Radar, select Standby. Press the POWER key again, and select Transmit.
Humminbird Radar: Select Radar Transmit. Tap the on/off button, or press the ENTER key, to turn it on.

 **NOTE:** For more information about Humminbird CHIRP Radar and Humminbird Radar, see **Radar Overview**.

Check Sensor Reception and Connections

If you've connected other separate-purchase equipment to the control head network, such as AIS, Compass/Heading Sensor, Radar, i-Pilot Link, 360 Imaging, and more, use these instructions to confirm the equipment is detected and communicating with the control head.

1. Press the HOME key.
2. Review the top, right corner of the status bar.



Detected and Active: If a sensor is active and transmitting/receiving, it will be white. See the table below.



Connected but not Detected or Active: If a sensor is not detected on the network, or not transmitting/receiving, it will be completely gray.



Connected but not Transmitting/Receiving: If a sensor is detected, but is not transmitting/receiving, the icon will be partially gray. In this illustration, the GPS receiver is detected, but it doesn't have a GPS fix. This feature will vary with the type of icon represented.

Active Status Icon	Sensor	Icon Description
	AIS	AIS is on and receiving targets.
	Bluetooth	The Bluetooth wireless remote is connected.
	Compass	The selected compass/heading sensor is on and heading data is being received.
	GPS	The GPS receiver is detected and a GPS fix has been obtained.
	i-Pilot Link	i-Pilot Link is connected, enabled, and actively navigating.
	Radar	The selected radar source is detected and transmitting.
	2D Sonar	The selected 2D sonar source is detected and pinging.
	360 Imaging Sonar	The 360 Imaging transducer is pinging data.

3. If the sensors are active, your system is ready for use on the water.

For additional system status, select Home > Settings > Network > System Info.

If you have connected an accessory to the control head, and the icon is not displaying in the system status bar, check the installation of the accessory and the cable connection to the control head.

To change the NMEA 2000 network or multi-control head network sources, see *Set up a NMEA 2000 Network* and *Set up your Humminbird Network*.

Review GPS Reception

In addition to the sensor icon in the status bar, you can also check the GPS reception status in the GPS tool. The GPS tool provides two ways to view the satellites communicating with the GPS Receiver. **Yellow** indicates that the satellite is being used to determine your current position. **Teal** indicates that the satellite is being monitored but not used. The following data is also displayed:

- **Position** [latitude and longitude]
- **GPS Fix Type:** reported as No Fix, 2D Fix, 3D Fix, or Enhanced. An Enhanced fix has been augmented using information from WAAS, EGNOS, or MSAS. A 3D or Enhanced Fix is required for navigation.
- **HDOP [the Horizontal Dilution of Precision]:** a GPS system parameter which depends on the current satellite configuration. HDOP is used to calculate the Estimated Position Error.

Open the GPS Tool

If there is more than one control head installed on the network, select the control head that is connected directly to the GPS receiver.

1. Press the HOME key.
2. Select the GPS tool.

Review Satellites and Signal Strength

1. Under GPS [1], select Satellites.
2. Under GPS [1], select Signal Strength.

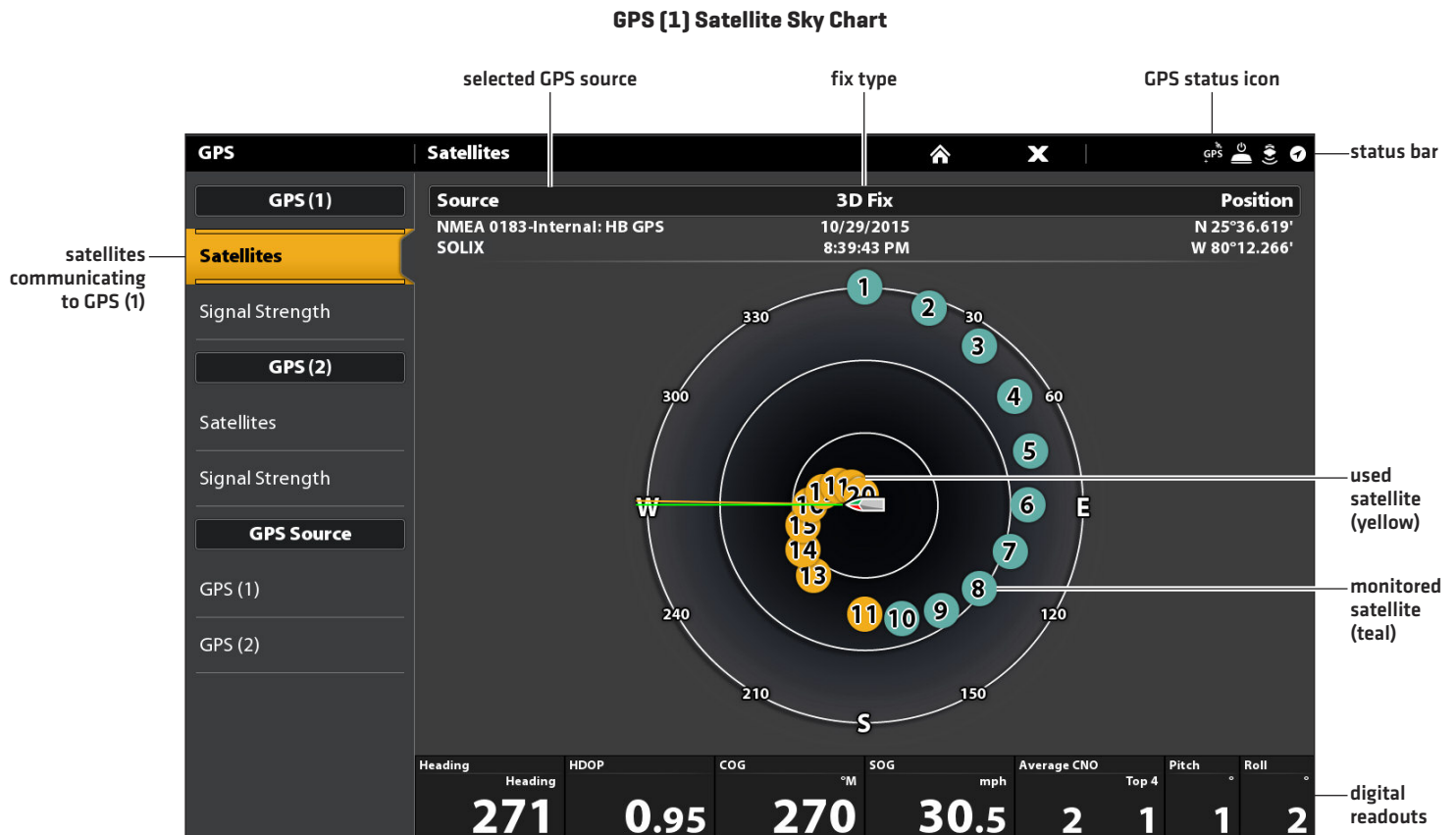

GPS (1) Satellites shows a sky chart and numerical data from the selected GPS receiver

Signal Strength (bar graph)

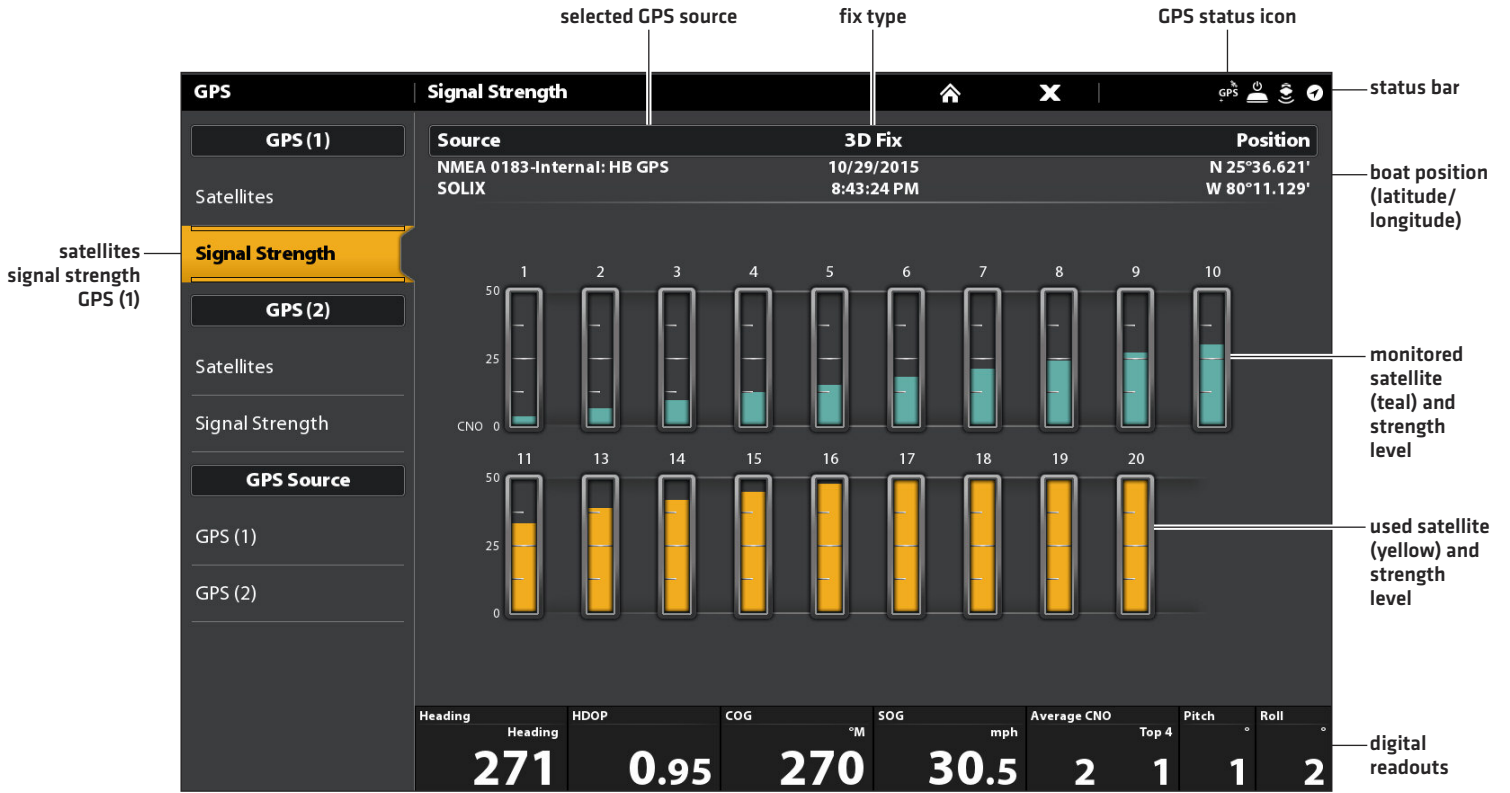

Signal Strength (GPS 1/GPS 2): displays vertical bar graphs indicating the satellite signal strengths with the respecting CNO (Carrier-to-Noise) value (0 to 60).

GPS (1) and GPS (2) Sources

You can also manually change which GPS receiver is the selected source for GPS [1] or GPS [2]. To change the GPS sources, see *Set up your Humminbird Network*.

GPS [1] provides position data, Speed over Ground (SOG), Course over Ground (COG), waypoints, routes, tracks, and navigation calculations to the control head.

GPS [2] provides position data that is displayed in the GPS [2] data box.

Set Alarms

When an alarm is turned on, an alert will sound or display on the control head to indicate the threshold has been exceeded.

1. Press the HOME key. Select Alarms.
2. Under Settings, select Alarms.

If the control head is connected to the Humminbird network, select **Local Alarms** [control head only] or **Networked Alarms** [alarms shared across control heads]. See **Set up your Humminbird Network** for more information.

3. Select an alarm category.
4. Select an alarm name.
5. **On/Off:** Tap the on/off button, or press the ENTER key, to turn on the alarm.
6. Adjust the alarm threshold.

Touch Screen: Press and hold the slider, or drag the slider.

Keypad: Press and hold the ENTER key, or turn the Rotary dial.

7. Repeat steps 3 through 6 for each alarm you want to set.

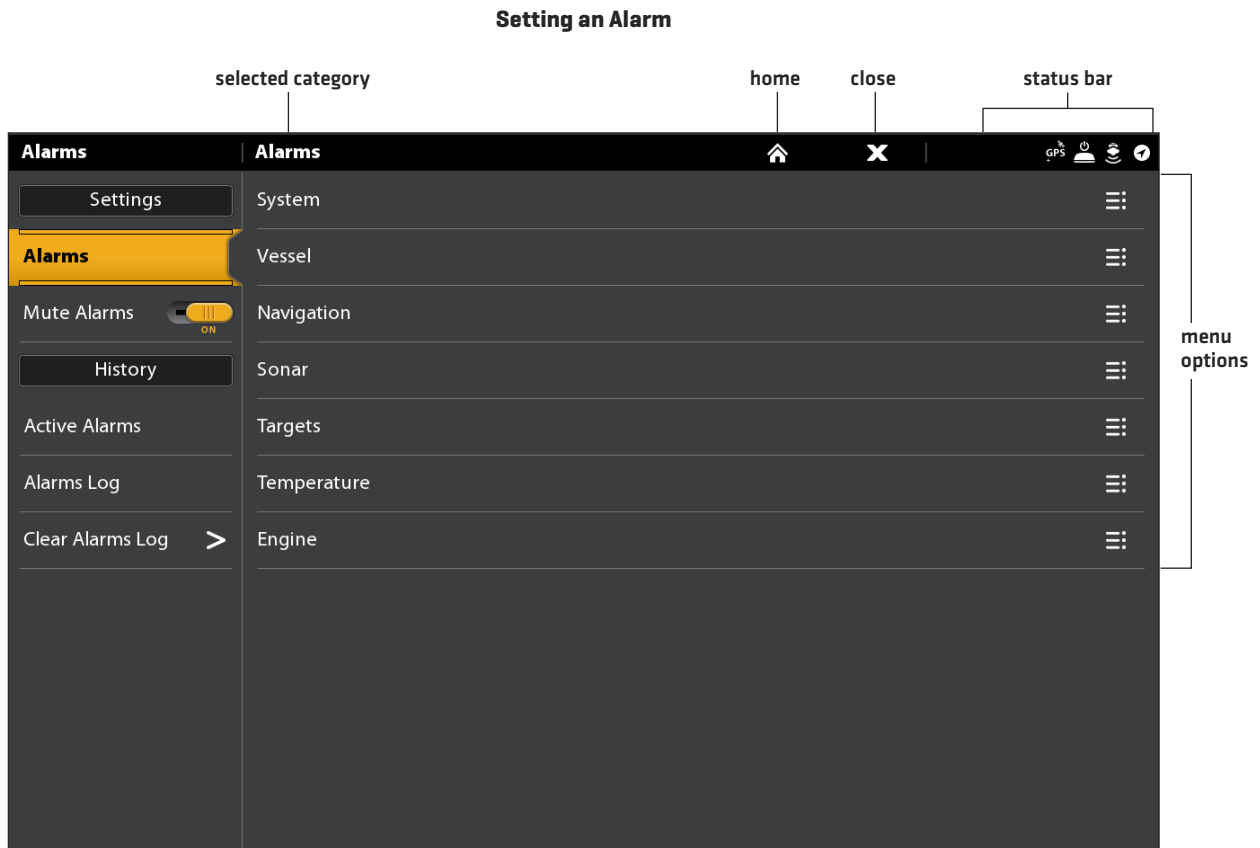

NOTE: See *The Menu System: Tips for Using the Status Bar* for more details.

The available alarms are determined by the connected equipment, so your control head may provide more or less options than the information shown here.

System	Voltage, Lost Heading [compass/heading sensor required], etc.
Vessel	Drift Limit, SOG [Speed over Ground], STW [Speed through Water], etc. Also, see Views: Understand the Data Box Digital Readouts for more information.
Navigation	See Chart Overview: Navigation Alarms Overview for details.
Sonar	See Sonar Overview: Sonar Alarms for details.
Radar	See Radar Overview: Radar Alarms for details.
Temperature	Temp [High] or Temp [Low]. To change the Temperature sources, see Installation Information: Set up your Humminbird Network .
Engine	Low Fuel, Engine Temp, Oil Level, Coolant Level, Check Engine, etc. To change Engine and Fuel sources, see Installation Information: Set up a NMEA 2000 Network .

Change System Settings

Your control head was configured during the installation setup. To change the system settings such as the backlight, key sounds, units of measurement, and the time and date format, select Settings from the Home screen. See **Manage your Control Head** for more information.

1. Press the HOME key.
2. Select Settings.
3. Select General.



NOTE: To reconfigure the control head with the Setup Guide, select the Setup Guide tool from the Home screen.

Start Standby Mode

To conserve power while the control head is not in-use, start Standby mode.

1. Press the POWER key.
2. Select Standby.
3. Press the RIGHT Cursor key.
4. **Turn off Standby Mode:** Press the POWER key.

Power Off

Many of the control head settings can be accessed quickly from the Power X-Press Menu. You can also turn off Radar transmission and change the transducer source from this menu.

Power Off

1. Tap the top, right corner of the status bar.

OR

Press the POWER key.

2. Select Power Off.



Additional Keypad Option

Press and hold the POWER key.

TOUCH SCREEN OVERVIEW

A summary of the touch screen actions are shown here. The touch screen actions are also determined by the view displayed on the screen.



TAP OR PRESS AND HOLD

Select a View, Tool, Menu, or Icon: Tap the selection once.

Activate the Cursor: Tap a position on the view. Press and hold a position to open the Cursor menu.

Zoom In: Tap the screen twice.



TWO FINGER TAP

Switch to 2D or 3D View: With a 2D Chart View displayed on-screen, tap twice to switch to 3D or back to 2D [Navionics only. See *Customize the Chart View*].

Zoom Out: Tap the screen twice.



PINCH IN/OUT

Zoom In: Touch the screen with two fingers and move them apart.

Zoom Out: Touch the screen with two fingers and bring them closer together.

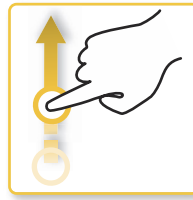

ONE FINGER SWIPE UP OR DOWN

Browse Menus: Swipe with one finger to scroll through a menu list [up or down].

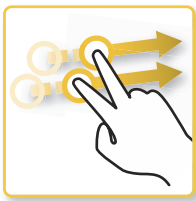

SWIPE SIDE TO SIDE

Next/Previous: With a Favorites View displayed on-screen, swipe [left or right] to view the next or previous view available.

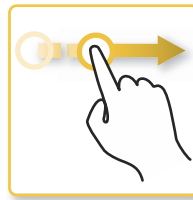

ONE FINGER SWIPE LEFT OR RIGHT

Adjust Menu Slider: Tap the menu to select it. Drag the slider to adjust the setting.

See More: Swipe the Favorites View bar and the Tools bar to browse through the icons on the Home screen.



SWIPE DOWN

Home Screen/View Toggle: With a view displayed on-screen, touch the screen with two fingers and swipe down to go to the Home Screen. To return to the previous view, swipe down with two fingers again.

Pan: With a Chart View displayed on the screen, drag one finger across the screen to see more of the chart that is displayed off-screen. With a 2D Sonar View displayed on the screen, drag one finger across the screen to see more of the sonar history.

SOLIX TOUCH SCREEN AND KEYPAD

SOLIX models allow you to use the touch screen and the keypad to select menus and start actions on the control head.

Select a Tool, View, or Menu

Touch Screen

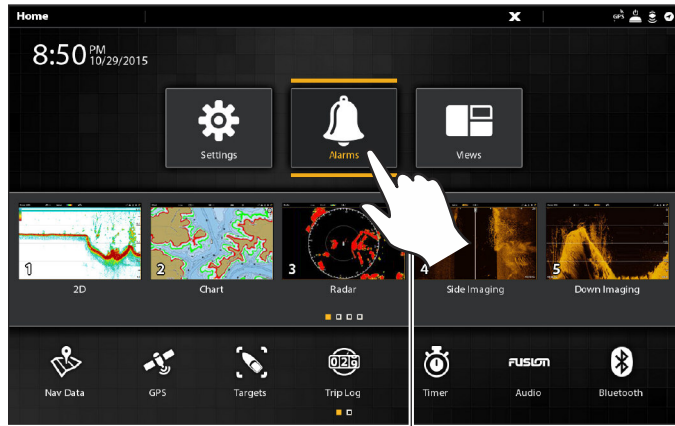

Tap to Select

Keypad

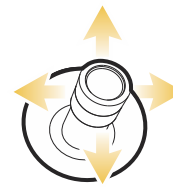

Select

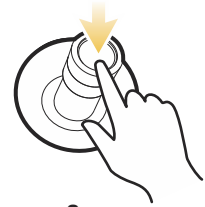

Open

Scroll to See More

Touch Screen

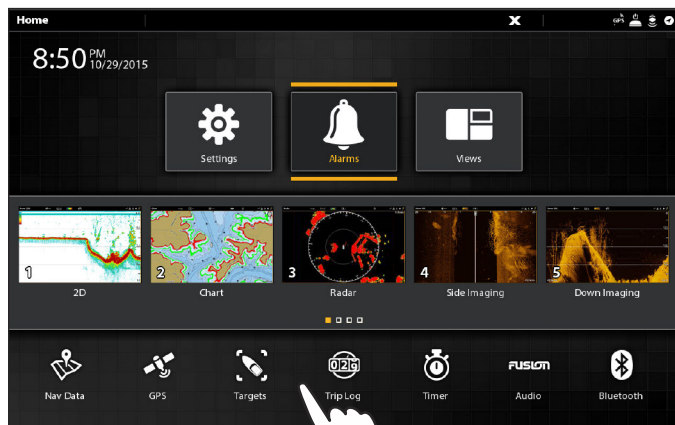

Swipe Left or Right

Keypad

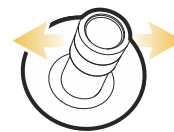

Move Left or Right

Adjust a Menu Setting

Touch Screen

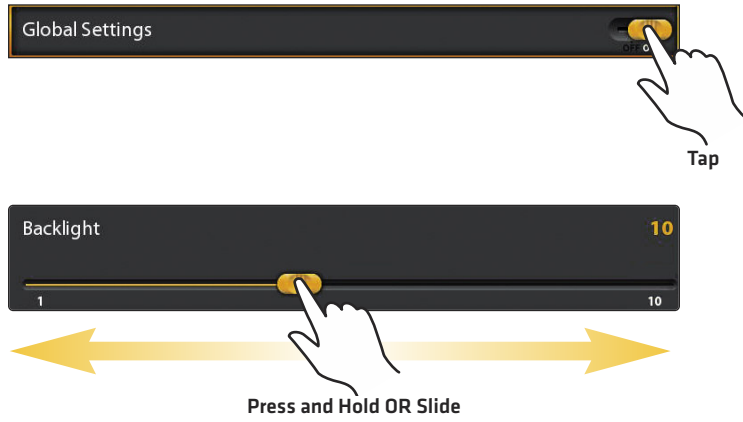

Keypad

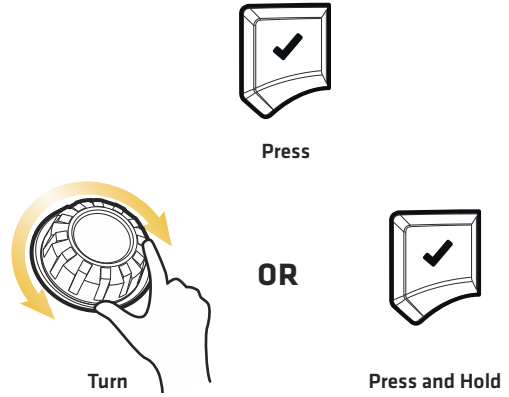

Activate the Cursor

Touch Screen

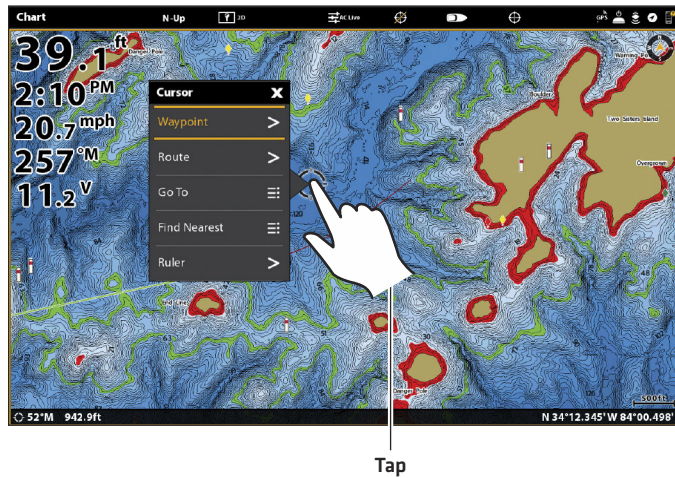

Keypad

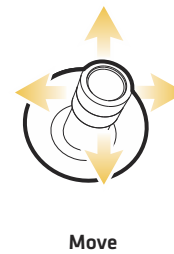

Zoom In, Zoom Out

Touch Screen

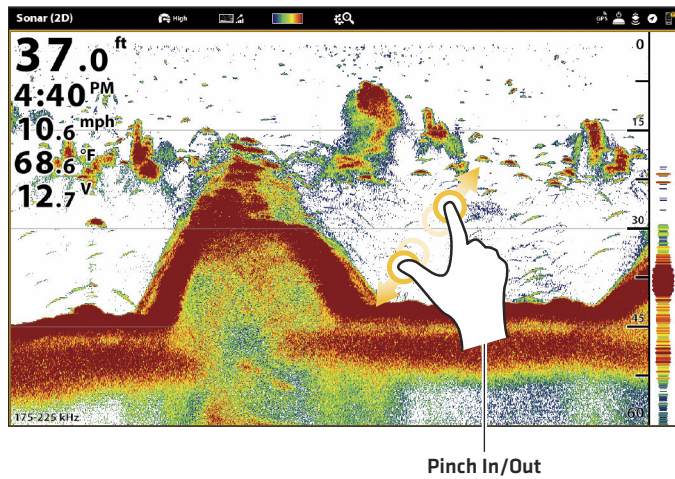

Keypad

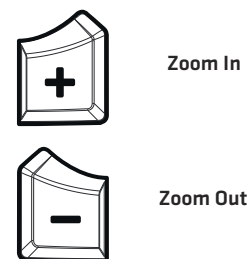



SOLIX Key Functions

The functions for each key are described here. To apply the key functions, see each section of this manual. You can also use the touch screen to replace key functions. See *SOLIX Touch Screen and Keypad* for more information.



POWER KEY

Press the POWER key to power on the control head. Press and hold the power key to power off.

During operation, press the POWER key to open the **Power X-Press Menu**: a menu with start-up functions, such as Sonar Source and Radar Transmit. The menu options depend on the accessories attached to the system.

The **backlight** and **touch screen** can also be adjusted from this menu.



ENTER KEY

Press the ENTER key to start a command or turn on a setting. The ENTER key also opens the Info menu and the Cursor menu. To adjust a menu setting, press and hold the ENTER key.



EXIT KEY

Press the EXIT key once to close a menu, close a dialog box, turn off an alarm, or exit Cursor mode.

Press and hold the EXIT key to close all menus at once.

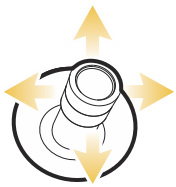

JOYSTICK

Move the Joystick to select a view, tool, or menu. Press the Joystick to open your selection.

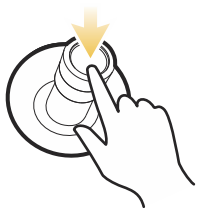

The Joystick is also used to move the cursor across the view, pan 2D/3D chart views, and select menu options and dialog box information.

Press the Joystick to mark a Route Point.

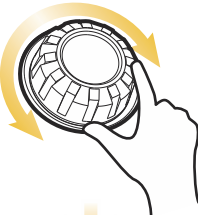

ROTARY DIAL

Turn the Rotary dial to adjust menu settings. Turn the Rotary dial in Sonar Views to adjust the sensitivity. Turn the Rotary dial in Chart View to zoom in and zoom out.

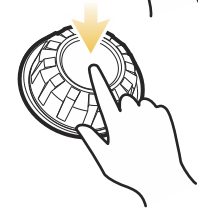

Press the Rotary dial to open the Views X-Press Menu.



ZOOM IN (+)/ZOOM OUT (-) KEYS

Press the individual ZOOM keys to change the scale of the view. **For a closer view**, press the ZOOM IN [+] key. **For a wider view**, press the ZOOM OUT [-] key. Press and hold the ZOOM OUT [-] key to Zoom out all the way.



MENU KEY

To open the X-Press Menu for the on-screen view and operation mode, press the MENU key once. To open the Main Menu [Settings tool], press the MENU key twice. To return to the last-used Settings tool tab, press and hold the MENU key. See **The Menu System** for details.



GO TO/SCREEN SNAPSHOT KEY

Press this key once to open the Go To menu for navigation functions. See **Routes** for details.

Press and hold this key to save the screen image. See **Images Tool** for details.



PANE KEY

Press the PANE key to open the View Options menu or to select a pane in a multi-pane view. The selected pane is highlighted in yellow. See **Views** for details.



MARK/MAN OVERBOARD KEY

Press and hold this key to start Man Overboard Navigation. To mark waypoints, press this key twice. See **Man Overboard (MOB)** and **Introduction to Navigation** for details.



HOME KEY

Press the HOME key to display the Home screen. The Home screen allows you to access Settings, Alarms, Views, and Tools for the control head. See **The Home Screen** for details.

SD CARD SLOTS



CAUTION! Before the control head software is updated or restored to system defaults, export your menu settings, radar settings, and navigation data [see **Update Software**].

Load Maps

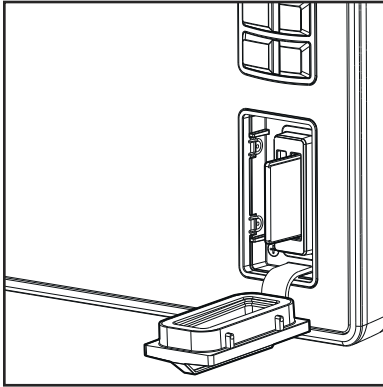

Insert the SD card with the label facing left

SD CARD SLOTS

Insert an SD card with the label facing left. SD cards can be used to load additional charts, import/export navigation data, save screen snapshots, import/export menu settings, and more.

The left slot is displayed as SD Card [1] in the menu system, and the right slot is displayed as SD Card [2].

THE HOME SCREEN

The Home screen is the main control center for your control head. Use the Home screen to access the control head settings, alarms, favorite views, and tools. The tools available on the Home screen are determined by the equipment attached to the control head network.

Open the Home Screen

Touch Screen

1. With a view displayed on-screen, touch the screen with two fingers and swipe down.
2. Tap a tool or view to open it.

Keypad

1. Press the HOME key.
2. Use the Joystick to select a tool or view. Press the ENTER key to open it.



Open the Home Screen



Tap to Select

OR

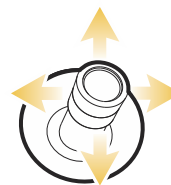

Select



Open

Main Settings



Select **Settings** to change general system settings such as the backlight, units of measurement, and the time and date format. You can also use this menu to change the main settings for each application (Sonar, Chart, Radar, etc.). See each related section of this manual for details.

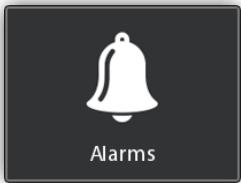

Select **Alarms** to view the alarm log, mute alarm sounds, and set the alarms for the individual applications. To set up individual alarms for navigation, sonar, radar, AIS, etc., see each related section of this manual for details. For example, for radar alarm settings, see **Radar Alarms**.

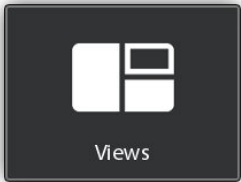

Select **Views** to access the complete set of views available on your control head. You can edit views, create your own views, and save your favorite views. See **Views** for more information.

Favorites Bar

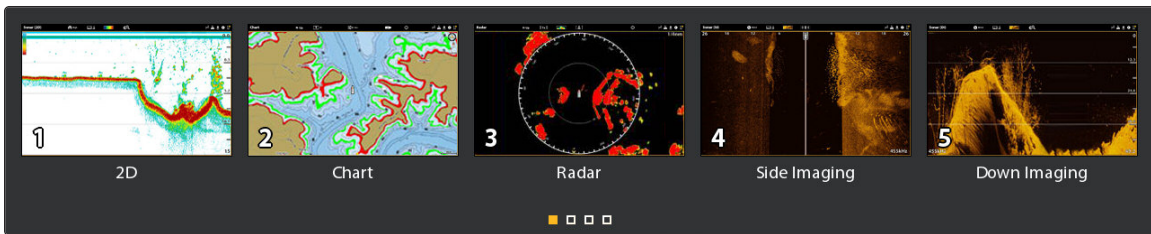

When you save a view to your **Favorites**, it is saved to the Favorites bar on the Home screen, so you can open it quickly. See **Views** for more information.

Tools Bar

The Tools bar on the Home screen allows you to manage the control head operations. When you connect an accessory to the control head, a related tool may also be displayed here.



Select **Nav Data** to manage your saved waypoints, routes, tracks, and groups. You can create new navigation data from this screen, edit your saved navigation data, or start navigation [see **Manage your Navigation Data**].

Required Equipment: GPS receiver [internal or external]



Select **Targets** to manage AIS and MARPA targets. See **AIS and MARPA** for more information.

Required Equipment: AIS or Radar, GPS receiver [internal or external], and compass/heading sensor



Select **Trip Log** to display Speed over Ground (SOG), timer for elapsed time, distance traveled since last reset, average speed, and trip fuel. You can also reset the trip log to zero and review trend data from this tool.

Required Equipment: GPS receiver [internal or external]



Select **Fuel** to review the fuel log for NMEA 2000 fuel sensors connected to the network. This tool provides refuel alerts and displays the fuel level in graphical form. See **Set up a NMEA 2000 Network** for details.

Required Equipment: NMEA 2000 tank sensor and/or fuel flow rate sensor



Select **Tides** to review information for the nearest tide station to your present position. The tool includes the position of the station and the times of the high and low tides for today's date. A tide graph is also displayed showing the rise and fall of the tides for the 24 hour time period encompassing the date. You can also search data for a selected date.

Required Map Source: Navionics



Select **Currents** to review information for the nearest current station to your present position. Two graphs are also presented that show the time, direction, and flow speed of the current changes for the 24 hour time period of today's date. You can also search data for a selected date.

Required Map Source: Navionics



Select **Sun + Moon** to review the sunrise and sunset for today or the date you select. The Moon data provides the rise and set of the moon and moon phases.



Select **Images** to manage your screen snapshots. When a screen snapshot is taken, a waypoint can also be saved at the current position. You can also choose to save the image on the control head or to an SD card. Also, screen snapshots and pictures from your camera's SD card [JPG Files] can be displayed in a slideshow from this tool. See **Images Tool** for more information.



Select **Recordings** to start a sonar recording or select a save location. You can also watch a sonar recording from the perspective of a 2D, SI, or DI View, depending on the capabilities of your model. See **Sonar Recording** for more information.

Required Equipment: transducer, black box sonar



Select **GPS** to review the signal strength of the GPS receivers ["sensors"] connected to the system. The tool shows the satellites in the area, the positions, and the signal strength for each one. You can also designate a primary and secondary GPS source from this tool. See **Getting Started**, **Installation Information**, and **Set up your Humminbird Network**.

Required Equipment: GPS receiver [internal or external]



Select **Files** to update the software for the control head or connected accessories. You can also import and export navigation data from this tool, and you can import and export menu settings. Radar installation settings can be managed from this tool, but only authorized radar technicians should use this menu. See the following sections: **Manage your Navigation Data** and **Manage your Control Head**.

Required Equipment: SD card



Select **Timer** to set an alarm clock for a selected time of day, use the countdown timer, or use the stopwatch. You can set more than one alarm clock.



Select **Setup Guide**, and the control head will guide you through the basic configuration settings for your control head, including units of measurement, language, transducer source, map source, and vessel settings. See your installation guide for details. To change the settings after setup, select Home > Settings.



Select **Bluetooth** to sync your wireless remote to the control head. You can also assign key functions for the remote from this tool. See your installation guide for details.

Required Equipment: wireless remote

THE MENU SYSTEM

The SOLIX provides menu options that change with the application, on-screen view, and the operations mode.

Open Settings

The Settings tool provides main menu settings for the control head.

1. Press the HOME key.
2. Tap Settings.

OR

Use the Joystick to select Settings. Press the ENTER key.

Selecting Settings



Navigation Main Menu

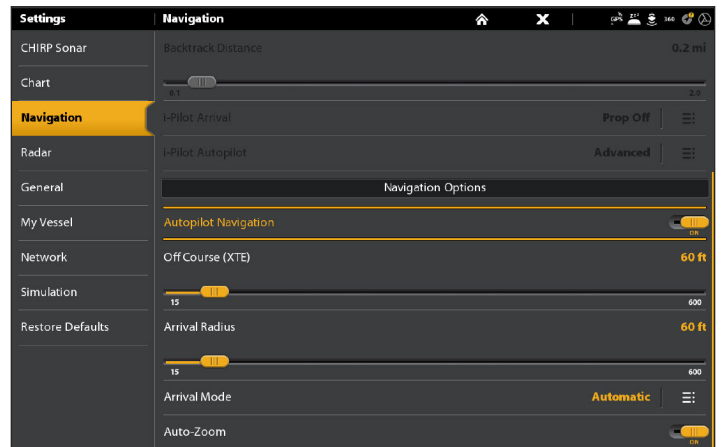

Tap Settings

OR

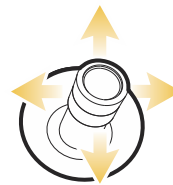

Select Settings



Open



Additional Keypad Option

With a view displayed on-screen, press the MENU key twice, or press and hold the MENU key.

Open an X-Press Menu

The X-Press Menu displays menu options for the on-screen view and operation mode (such as navigation). In a multi-pane view, the X-Press Menu options are determined by which pane is selected. See **Views** for more information.

Open an X-Press Menu

1. With a view displayed on-screen, tap the view name in the status bar.

OR

Press the MENU key.

Open an X-Press Menu in a Multi-Pane View

1. With a Multi-Pane View displayed on-screen, tap a pane.

OR

Press the PANE key to select a pane.

2. Tap the pane name in the status bar, or press the MENU key.

Opening an X-Press Menu for a Selected Pane

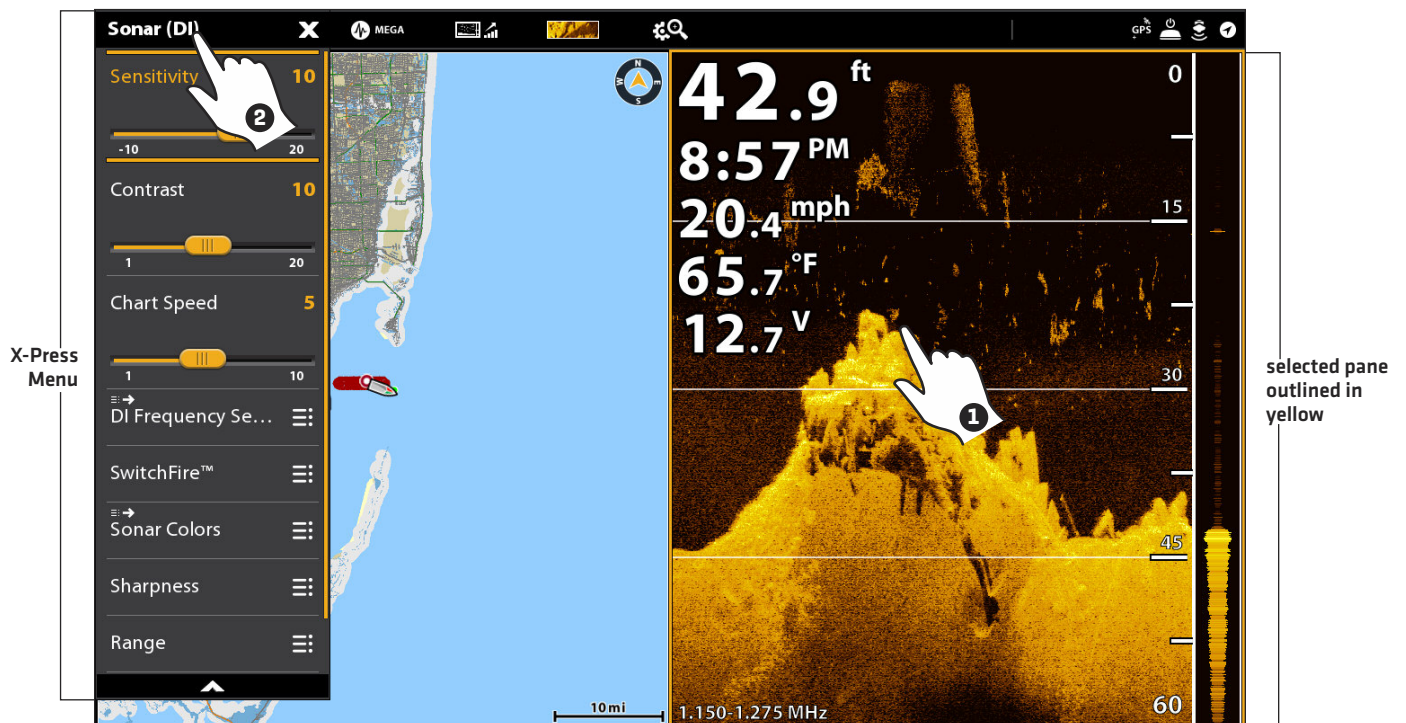

Tap to Select a Pane
and the Menu

OR



Press to Select a Pane



Press the MENU key

Change a Menu or Start an Action

Use the following instructions to change a menu setting or start an action through the menu system.

1. Tap a menu category, or use the Joystick to select it.
2. Tap a menu option, or use the Joystick to select it.
3. Adjust the setting or start an action using the touch screen or keys. See *Tips for Changing a Menu*.

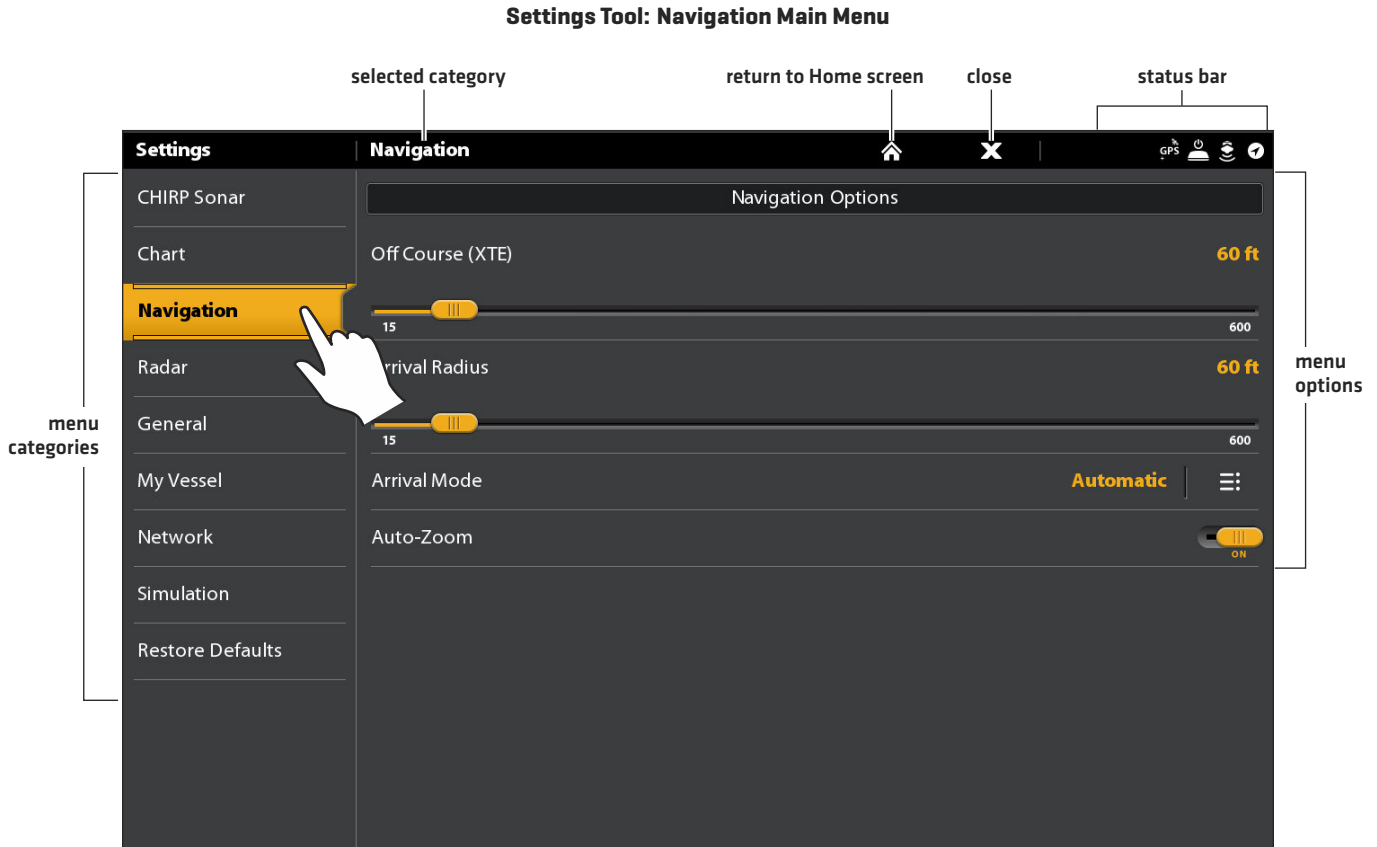

Tap to Select

OR

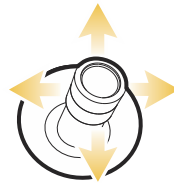

Select



Open



NOTE: See *The Menu System: Tips for Using the Status Bar* for more details.

Tips for Changing a Menu

This section describes the different types of menus in the menu system and how to change them using the touch screen or keypad.

Action (>)

Touch Screen



Keypad



On/Off Button

Touch Screen

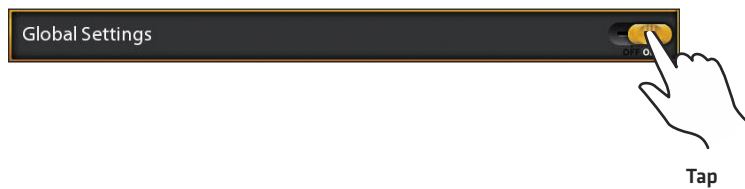

Keypad



Slider

Touch Screen

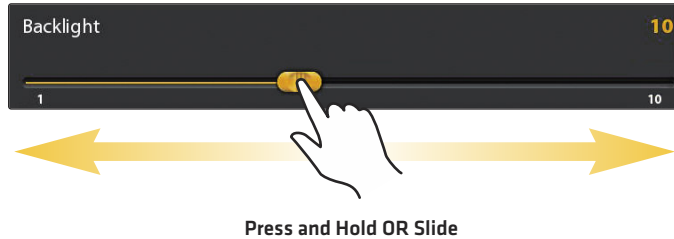

Keypad



Pick List or Check Box

Touch Screen

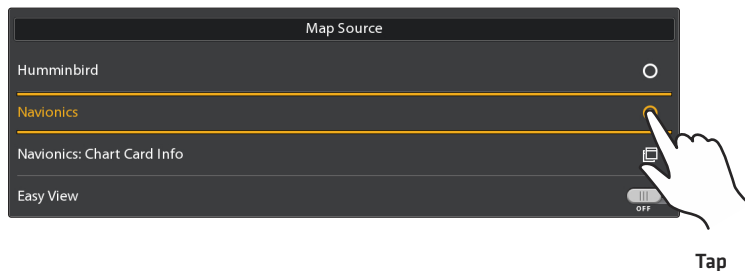

Keypad

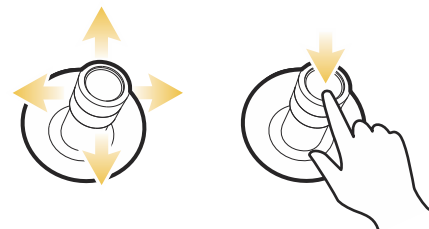

You can also use the Joystick to make selections.

Tips for Using the On-Screen Keyboard

Use the on-screen keyboard to rename the control head in the network, edit your navigation data, and more.



Tap to Select a Character

OR

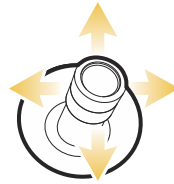

Highlight a Character

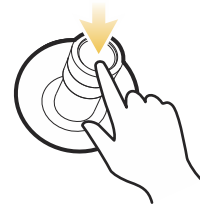

Press to Select the Character

Tips for Using the Status Bar

The status bar is located at the top of the screen. It changes to match the on-screen view and operation mode.

In the following illustration, the information in the status bar corresponds with the Chart View displayed on-screen. You can tap the icon in the status bar to open a menu, return to the Home screen, close a menu, or make a selection. You can also use the corresponding keys.

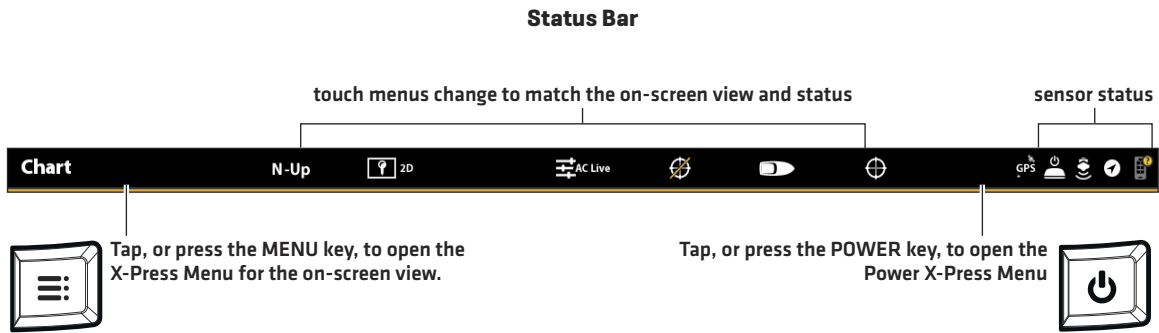

Close a Menu

When you close a menu, your settings are saved until you change them again or until the control head defaults are restored.

1. **Back:** Tap the Back icon  to close the current menu and go back one level in the menu system.

OR

Press the EXIT key.

2. **Close:** Tap the X icon .

OR

Press the EXIT key. To close several menus at once, press and hold the EXIT key.

 **NOTE:** The X icon is displayed in the status bar or at the top of a menu. The location will vary with the item displayed on the screen.

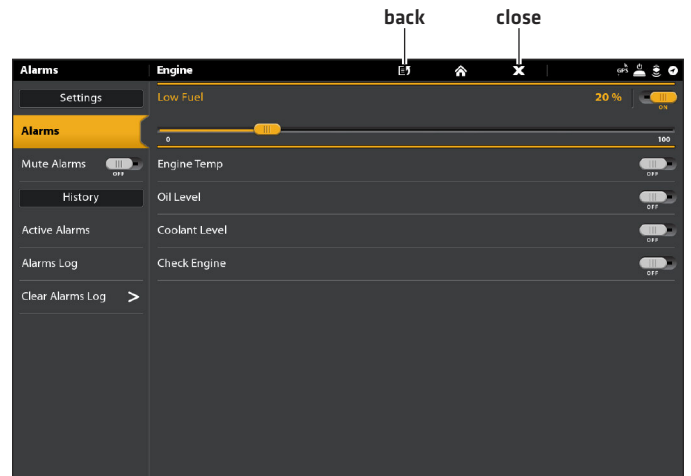

Change the User Mode

The SOLIX control head is automatically set to Angler Mode [recommended], which is configured with the best settings for a wide range of fishing conditions. To access in-depth customization menu options, set the user mode to Custom.



NOTE: Export your menu settings and radar settings to an SD card before changing settings in Custom mode.

Change the User Mode

1. Press the HOME key.
2. Tap Settings.

OR

Use the Joystick to select Settings. Press the ENTER key.

3. Select General.
4. Under User Mode, select Angler or Custom.

VIEWS

There are many options to display data on-screen, and the data can be displayed in a variety of ways. You can open a view from the Favorites bar or from the Views tool. You can also create a new view, edit views, and customize the Favorites bar. To add a view to the Favorites bar, or to remove a view, see *Add or Remove the View from the Favorites Bar*.

Display a View from the Favorites Bar

The Favorites bar includes preset views for your control head. When you attach an accessory to the control head or network, related views may be added to the Favorites bar. You can also change which views are saved to the Favorites bar.

Display a View

Touch Screen

1. Touch the screen with two fingers and swipe down, or press the HOME key.
2. Tap a view on the Favorites bar.

Keypad

1. Press the HOME key.
2. Use the Joystick to select a view on the Favorites bar. Press the ENTER key to display it on-screen.

Rearrange the Views in the Favorites Bar

You can change the order in which the views are displayed in the Favorites bar.

Rearrange Views

Touch Screen

1. Press and hold a view on the Favorites bar.
2. Tap the LEFT or RIGHT arrows to move the view.
3. **Save:** Tap the X icon in the status bar.

Keypad

1. Select a view on the Favorites bar.
2. Press and hold the ENTER key.
3. Press the ZOOM IN [+] or ZOOM OUT [-] keys to move the view.
4. **Save:** Press the EXIT key.

Displaying a View from the Favorites Bar



Tap to Select

OR

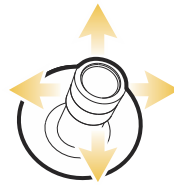

Select



Open

Display a View from the Views Tool

The Views tool includes the complete database of available views for your control head. Use the Views tool to create a new view and edit a view. You can also edit the Favorites bar from the Views tool.

1. Press the HOME key.
2. Select the Views tool.
3. Select a Group. To see all available views, select All.
4. Tap the View.

OR

Use the Joystick to select a view. Press the ENTER key to display it on-screen.

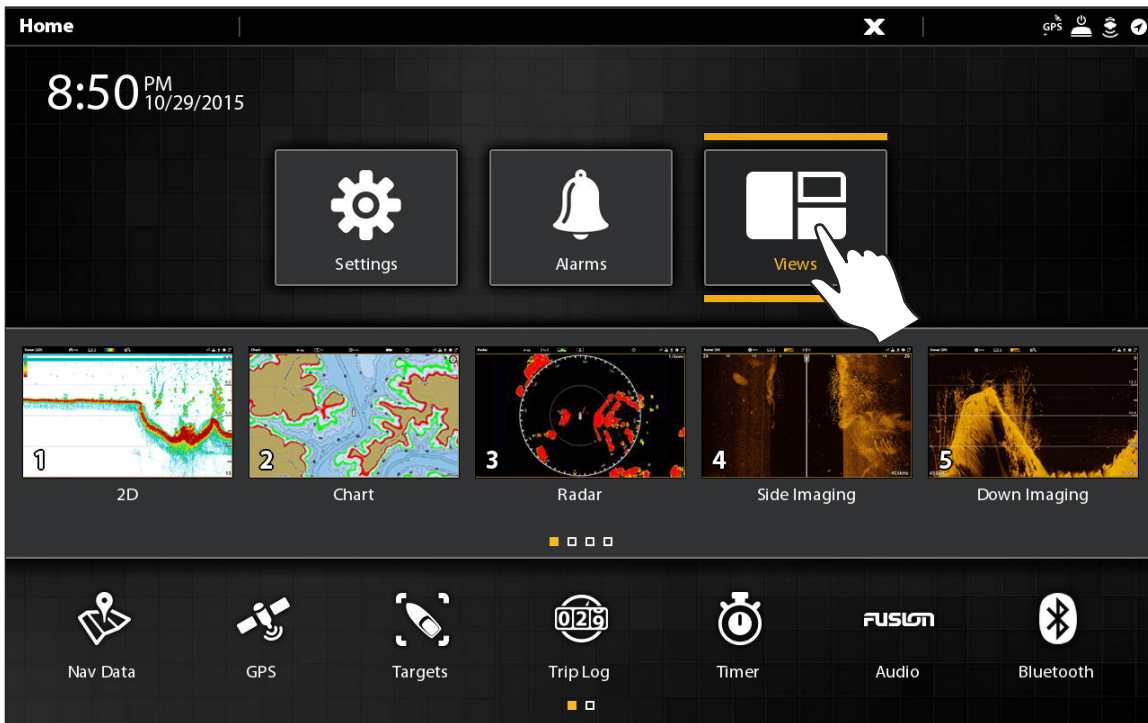

Tap to Select

OR

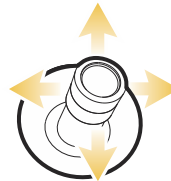

Select



Open

Views Tool

selected group

star = favorite

return to Home screen

close

status bar

Groups

View Options

Name

Favorite View

Edit

Duplicate

Delete

Options

New View

groups

Options: select to create a new view

available views



Tap to Select

OR

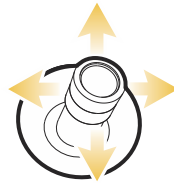

Select



Open

EDIT THE ON-SCREEN VIEW

You can edit a view from the Views tool or from the view that is displayed on the screen. When you edit a view from on-screen, the View Options menu provides additional editing options.



Global: To apply changes to all views in the same category, turn on Global. To apply changes to the on-screen view exclusively, turn off Global.

The menu options in Data bar, Options, Preferences, and Overlays change to match the on-screen view. The menu options are described in detail in each section. For example, for Sonar Overlay settings, see [Sonar Overview](#).

Change the View Appearance (Preferences)

Use the Preferences menu to change the appearance of the display. The menu options are determined by the type of view on-screen, and there are many options for each view. For example, in a Sonar View, you can choose the palette, turn on Fish ID+, display or hide the Real Time Sonar Window, and more.

1. With a View displayed on-screen, tap the view [or pane] name in the status bar, or press the MENU key once.
2. Select Options. For example, in a Sonar View, select Sonar Options. In a Chart/Sonar View with the Chart pane selected, select Chart Options.
3. Select Preferences.
4. Use the touch screen or Joystick to select a menu and change a setting.

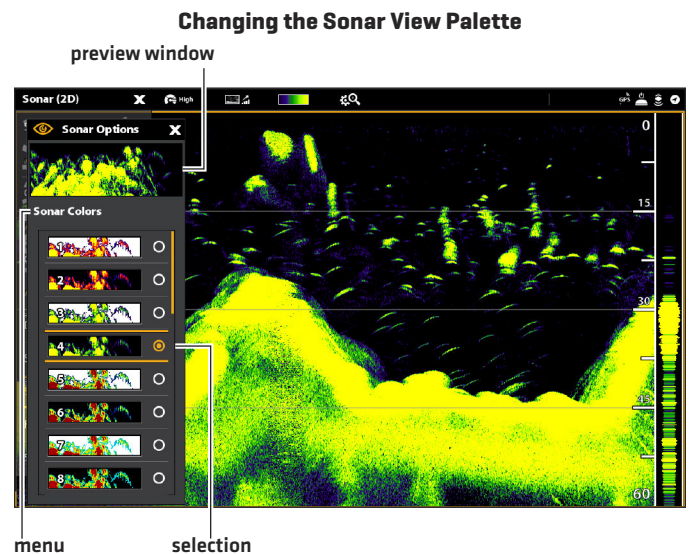

Change the View Overlays

Use the Overlays menu to display or hide information on the view. For example, in a Chart View, you can display or hide the vessel icon, and you can choose which navigation data [waypoints, routes, tracks, etc.] you want to display on the view.

1. With a View displayed on-screen, tap the view [or pane] name in the status bar, or press the MENU key once.
2. Select Options. For example, in a Sonar View, select Sonar Options. In a Chart/Sonar View with the Chart pane selected, select Chart Options.
3. Select Overlays.
4. Use the touch screen or Joystick to select a menu and change a setting. [check mark = visible, blank = hidden].

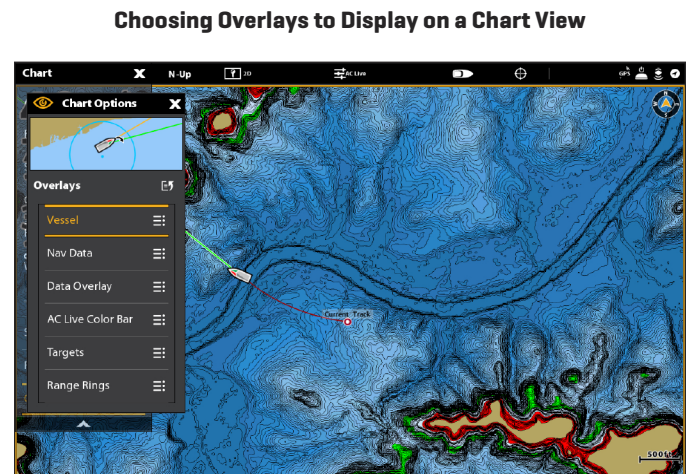

Display Data Overlays

Digital readout data can be displayed as an overlay, and it can be displayed in the data bar. To turn on the data bar, see [Display a Data Bar](#).

1. With a View displayed on-screen, tap the view [or pane] name in the status bar, or press the MENU key once.
2. Select Options. For example, in a Sonar View, select Sonar Options. In a Chart/Sonar View with the Chart pane selected, select Chart Options.
3. Select Overlays.
4. Select Data Overlay.
5. Select Show Data. Tap the on/off button, or press the ENTER key, to turn it on.
6. Use the touch screen or Joystick to make items visible on the view. [check mark = visible, blank = hidden].

Chart View with Data Overlays Displayed

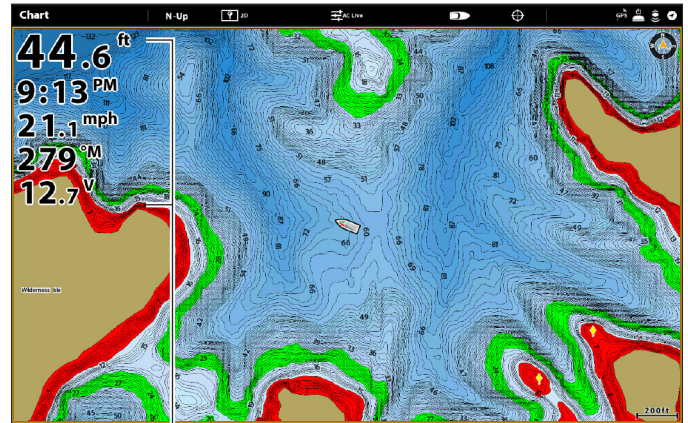

data overlays

Display a Data Bar

Your control head allows you to choose a standard data bar or a navigation data bar with preset data boxes. If you attach additional accessories to the control head or network, additional data bar options may also be displayed. The data boxes in the data bar can also be changed.

Select the Data Bar Type

1. **View Options Menu:** With a view displayed on-screen, press the PANE key once. In a multi-pane view, press the PANE key repeatedly until the menu displays.
2. Select Data Bar from the View Options menu.
3. Select the type of data bar to display. To hide the data bar, select Off.



NOTE: To display digital readouts as an overlay, see [Display Data Overlays](#).

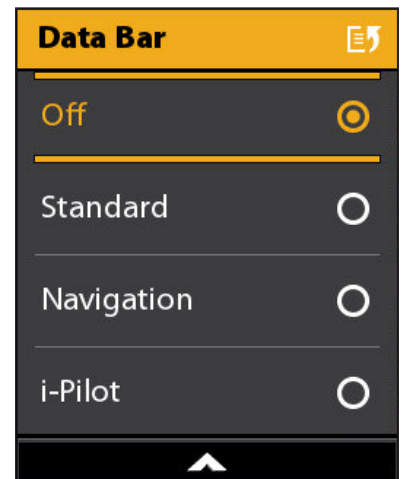

Change the Data Boxes

Use the following instructions to change the data boxes displayed in a data bar.



NOTE: A data bar must be displayed to access the menu options in this section. See **Display a Data Bar**.

1. **View Options Menu:** With a view displayed on-screen, press the PANE key once. In a multi-pane view, press the PANE key repeatedly until the menu displays.
2. Select Edit Data.
3. To edit the Standard data bar, select Standard Data. To edit the Navigation data bar, select Navigation Data.

Global (Optional): To apply the changes to all views using the data bar, turn on Global. To apply changes to the on-screen view exclusively, turn off Global.

4. Use the Joystick to choose a data box. Press the Joystick to select it.
5. Select a data type from the menu.
6. Select a data label.
7. **Close:** Press the EXIT key. Press the PANE key.

Selecting a Data Box



Selecting the Data Type

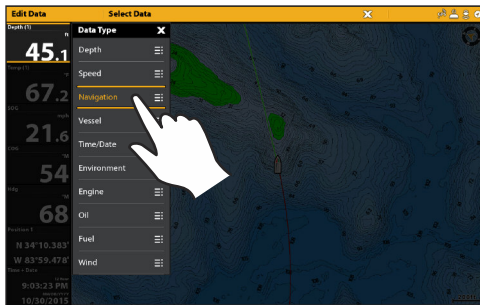

Selecting the Data Label

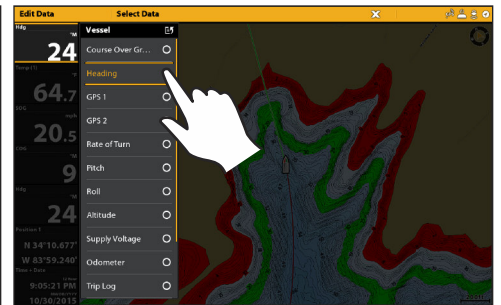

Tap to Select

OR

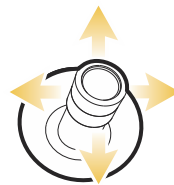

Select



Open

Understand Data Box Digital Readouts

The table below displays the basic data box options that are shown in the Standard data bar and the Navigation data bar, as well as the additional data box options for vessel, wind, and engine. The data box options are determined by the installed equipment and the selected sources on the network. Your control head provides a wide variety of data box options, more than the information shown here.

The number on the data label [Temp 1, Temp 2, Temp 3, etc.] corresponds with the source number. For more information about sources and networking, see *Installation Information, Set up your NMEA 2000 Network*, and *Set up your Humminbird Network: Select Data Sources*.

Label	Name	Description	Data Type
Alt	Altitude	The height measurement above sea level.	Vessel
AWA	Apparent Wind Angle	The direction of wind relative to the bow of the vessel.	Wind
AWS	Apparent Wind Speed	The speed of wind with respect to the speed of the vessel.	Wind
Brg	Bearing	The compass direction from the vessel position to the next waypoint or route point.	Navigation
Brg [End]	Bearing [To End]	The compass direction from the vessel position to the final point in a route.	Navigation
Course	Course	The intended direction of travel measured between the start point and end point.	Navigation
CMG	Course Made Good	The bearing from your starting position to the present vessel position. The goal is to have CMG and Track equal to the same number.	Navigation
COG	Course Over Ground	The current direction the boat is traveling measured in degrees from North. When the COG is equal to Bearing, the boat is said to be on course and will arrive at the destination in the most efficient manner.	Vessel
CTS	Course to Steer	The heading that must be maintained in order to reach the planned destination.	Navigation
Depth [#]	Depth	The depth of the water from the transducer or digital depth sensor to the bottom. This measurement includes the depth offset setting.	Depth
Dest Wpt ID	Next Waypoint	The next point [waypoint, route point, Man Overboard point, etc.] that the vessel is navigating towards in a route or other navigation mode.	Navigation
DBT	Depth Below Transducer	The depth of the water below the transducer. This measurement does not include the depth offset setting.	Depth
DMG	Distance Made Good	The straight line distance actually traveled between the start position to the current vessel position.	Navigation
DTG	Distance to Go	The distance between the vessel position and the next waypoint or route point.	Navigation
Eng Temp [#]	Engine Temperature	The engine temperature from the engine source.	Engine
Eng Volt [1]	Engine Voltage	The power supplied to the engine source.	Engine
ETA	Estimated Time of Arrival	The estimated time of arrival to the next waypoint on the route.	Navigation

Label	Name	Description	Data Type
Fuel [#]	Fuel Level	The fuel level of the fuel source.	Fuel
Hdg	Heading	The direction the boat is pointing, measured in degrees. Due to wind and waves, the boat is often traveling in a slightly different direction than its heading. See Course Over Ground [see COG].	Vessel
Heat Index	Heat Index	The perceived temperature derived from air temperature and relative humidity.	Environment
Next Turn	Next Turn	The course of the next route leg with respect to the current heading.	Navigation
Odo	Odometer	The distance traveled.	Vessel
Pitch	Pitch	The rotation angle of the boat from front to back [bow to stern].	Vessel
Position [#]	GPS	The latitude and longitude coordinates of the vessel position based on the GPS receiver installation location.	Vessel
Roll	Roll	The rotation angle of the boat from side to side [port to starboard].	Vessel
ROT	Rate of Turn	The rate at which the boat is turning, measured in degrees per second.	Vessel
RPM	Revolutions Per Minute	The number of engine revolutions per minute.	Engine
SMG	Speed Made Good	The distance from the starting waypoint on the route divided by the time elapsed since starting navigation on the route.	Speed
SOG	Speed Over Ground	The measurement of the boat's progress across a given distance and the speed measurement provided by GPS. SOG is optimal for navigation because accurate destination times can be derived from this measurement.	Speed
STW	Speed Through Water	The measurement of the flow past the boat, which may vary depending on current speed and direction.	Speed
Temp [#]	Water Temperature	The detected water temperature.	Environment
Temp [Air]	Air Temperature	The detected air temperature.	Environment
TTG	Time to Go	The estimated time required to reach the next waypoint on the route. TTG is calculated using the SOG [Speed Over Ground] and DTG [Distance to Go].	Navigation
TWA	True Wind Angle	The wind angle detected when the vessel is stationary.	Wind
TWS	True Wind Speed	The wind speed detected when the vessel is stationary.	Wind
VMG	Velocity Made Good	The speed of travel relative to the next waypoint on the route.	Speed
XTE	Cross Track Error	The straight-line distance of the boat from the intended Track. XTE measures how far the boat is off course.	Navigation

THE VIEW OPTIONS MENU

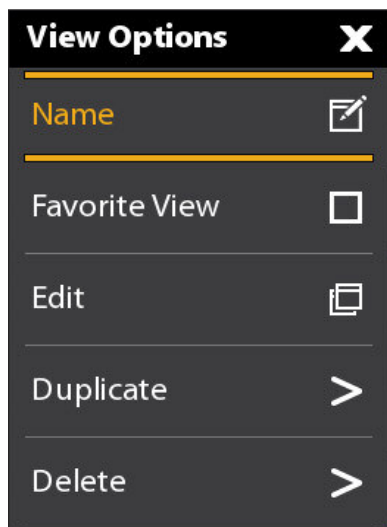

The **View Options menu** provides options to edit the selected view. You can open the View Options menu from the on-screen view or from the Views tool on the Home screen.

The menu options vary slightly. For example, if you open the View Options menu from an on-screen view, you can also edit the data bar from the menu. If you open the View Options menu from the Views tool, you can duplicate and delete the view from the control head.

Open the View Options Menu for the On-Screen View

1. With a view displayed on-screen, press the PANE key once. In a multi-pane view, press the PANE key repeatedly until the menu displays.
2. **Close:** Press the PANE key.

Opening the View Options Menu

View Options menu

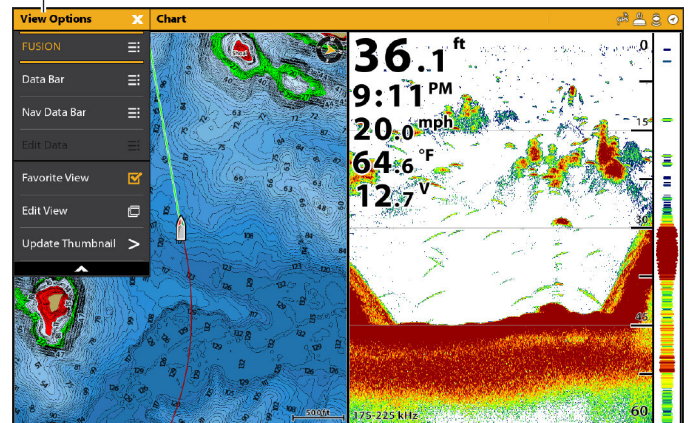

Open the View Options Menu from the Views Tool

1. Press the HOME key.
2. Select the Views tool.
3. Press and hold the view you want to edit.

OR

Use the Joystick to select a view. Press the MENU key.

4. **Close:** Press the EXIT key.

Opening the View Options Menu from the Views Tool

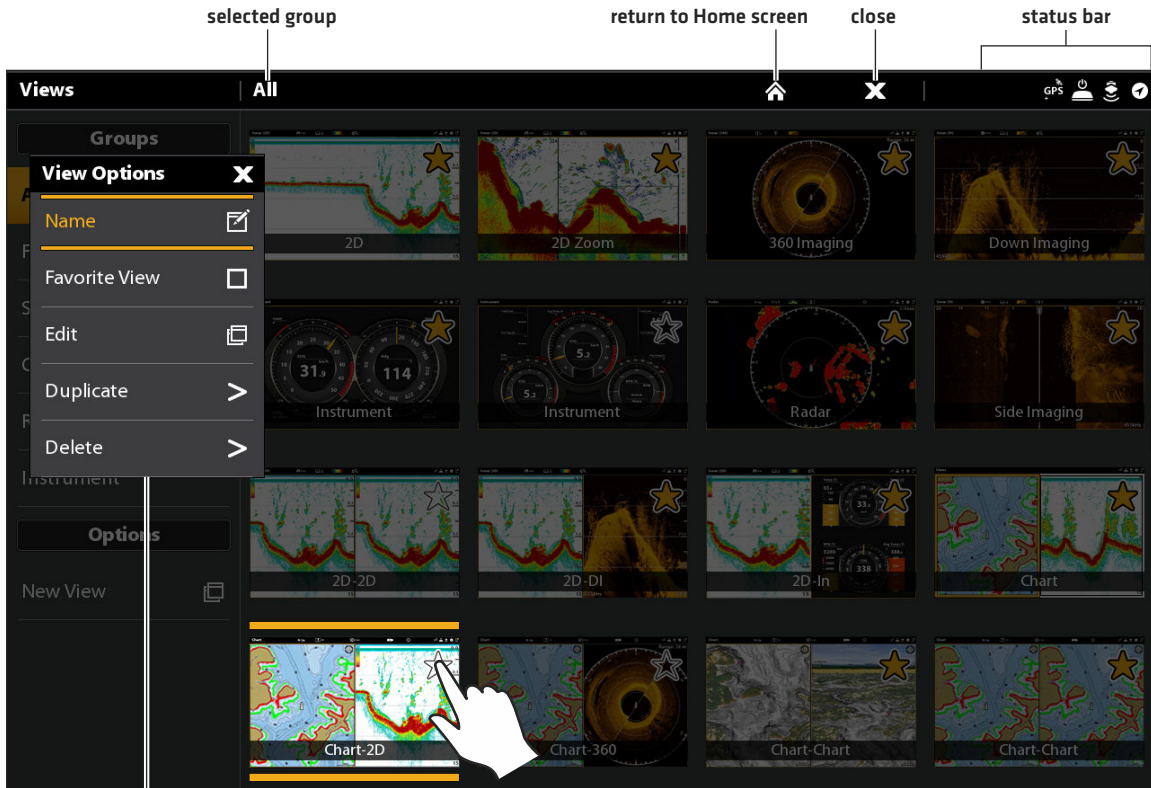

View Options Menu



Press and Hold

OR

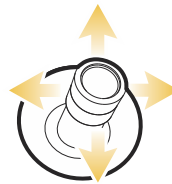

Select



Open the View Options Menu

CREATE A NEW VIEW

Follow the instructions in this section to create a new view from a blank template.

1. Press the HOME key.
2. Select the Views tool.
3. Select New View.
4. See *Edit the View Layout and Application* to rename the view, edit the layout, add applications, display digital readouts, and more.

Creating a New View

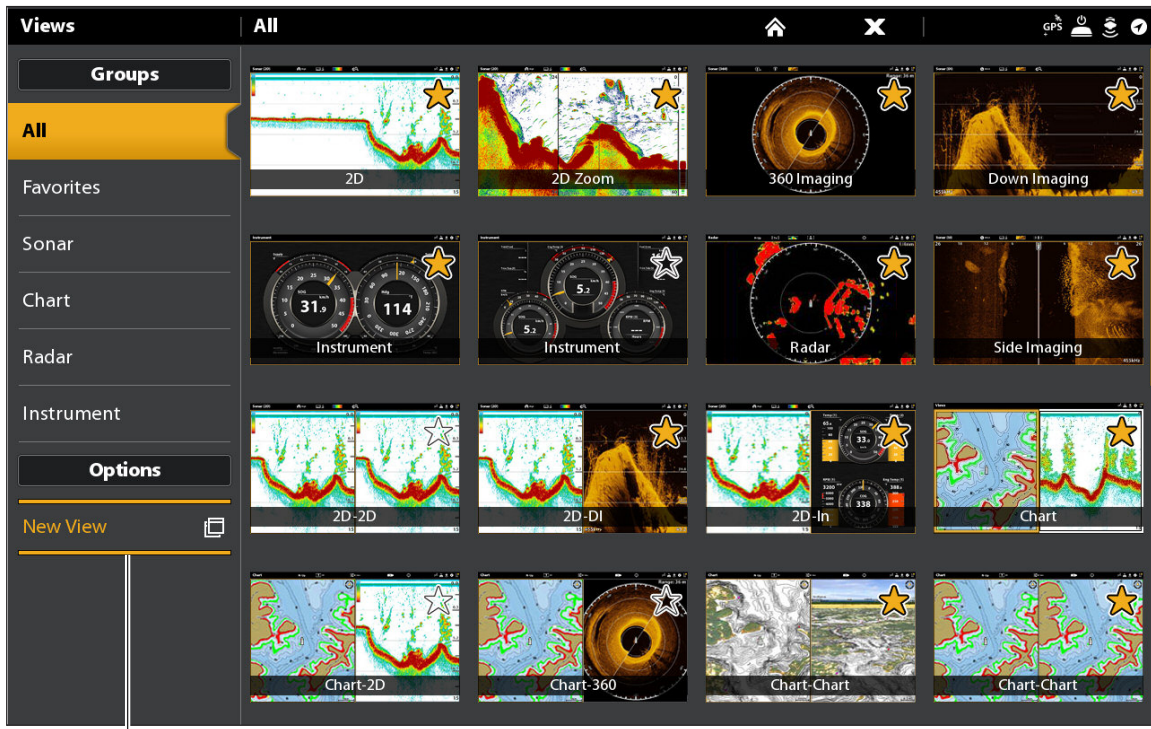

select to create a new view

Edit the View Layout and Application

The Edit menu on the View Options menu allows you to change the type of data that is displayed in the view and how many panes are displayed.

1. Select Edit (or Edit View) from the View Options menu.
2. To change the layout and number of panes in the view, select Template. If you do not want to change the layout, skip to step 4.
3. Tap the template, or use the Joystick, to select the layout you want to use.
4. To change the type of data displayed in the view, select Applications.
5. Tap the pane and then tap the type of data to fill the pane.

OR

Turn the Rotary dial to select a pane. Use the Joystick to choose an application, and press the Joystick to select it.

6. Repeat steps 4 and 5 until the panes are filled.
7. Select Save.

Selecting a View Template

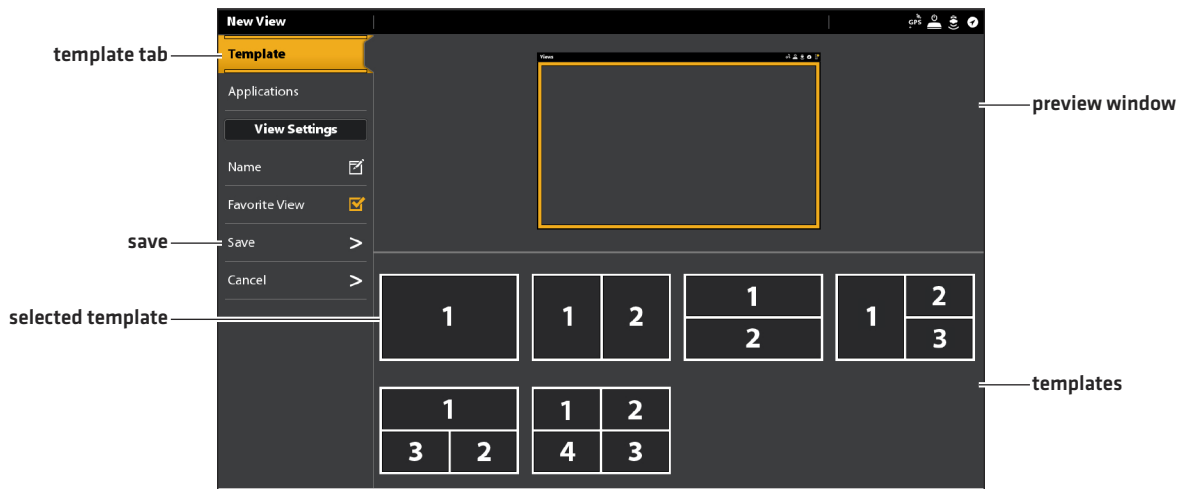

Tap to Select

OR

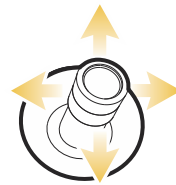

Select a Template

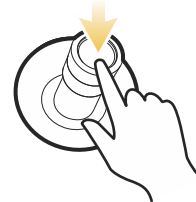

Open

Adding Applications to the Template

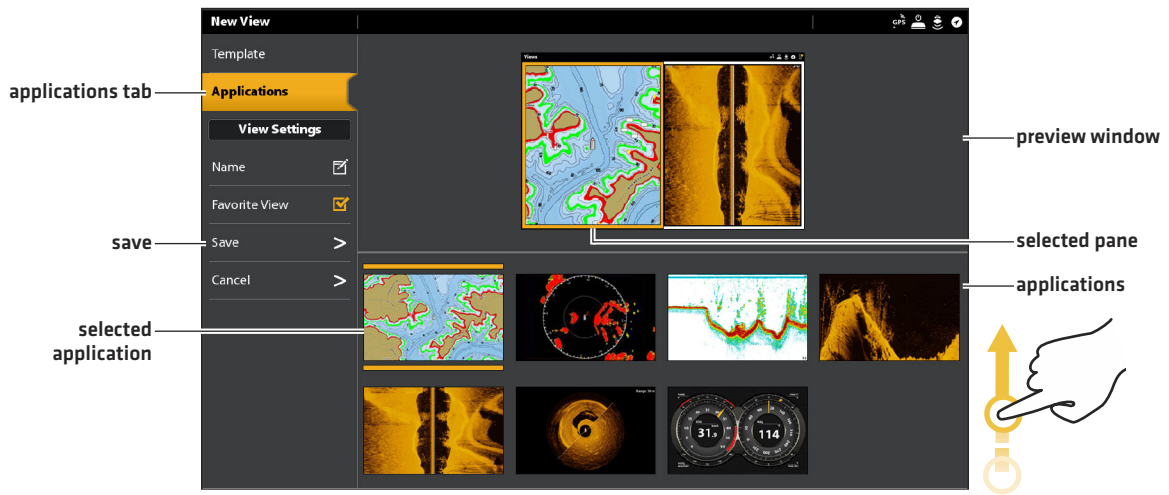

Tap to Select

OR



Select a Pane

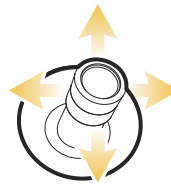

Select an Application

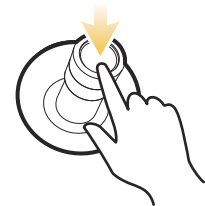

Add

Change the View Name (Views Tool)

1. Select Name from the View Options menu.
2. Use the on-screen keyboard to edit the view name. See *The Menu System: Tips for Using the On-Screen Keyboard* for more information.

Add or Remove the View from the Favorites Bar

To rearrange the order of views in the Favorites bar, see *Views: Rearrange the Views in the Favorites Bar*.

1. Select Favorite View from the View Options menu.
2. Tap the menu, or press the ENTER key, to add/remove the check mark. [Check mark = Favorites bar, Blank = not included in the Favorites bar]

Optional: In the Views tool, tap the star to add/remove the view from the Favorites bar. [Star = Favorites bar, Blank = not included in the Favorites bar]



Duplicate the Selected View (Views Tool)

When you duplicate a view, the control head creates a copy. You can rename the new view, edit it, and change the layout.

1. Select Duplicate from the View Options menu.
2. Tap the menu, or press the ENTER key, to create a copy.

Delete the Selected View (Views Tool)

1. Select Delete from the View Options menu.
2. Tap the menu, or press the ENTER key, to delete the view.

SET UP AN INSTRUMENT VIEW

The SOLIX control heads provide Instrument Views in a variety of combinations to display on-screen. You can use the standard Dashboard Instrument View or Engine Instrument View. You can also customize the gauges, data boxes, and ranges.



NOTE: The data boxes and gauges must have input from connected and powered equipment. The Engine Instrument View must have input from a NMEA 2000 network to provide source data. For more information about sources and networking, see *Installation Information*, *Set up your NMEA 2000 Network*, and *Set up your Humminbird Network*.

Instrument View: Dashboard

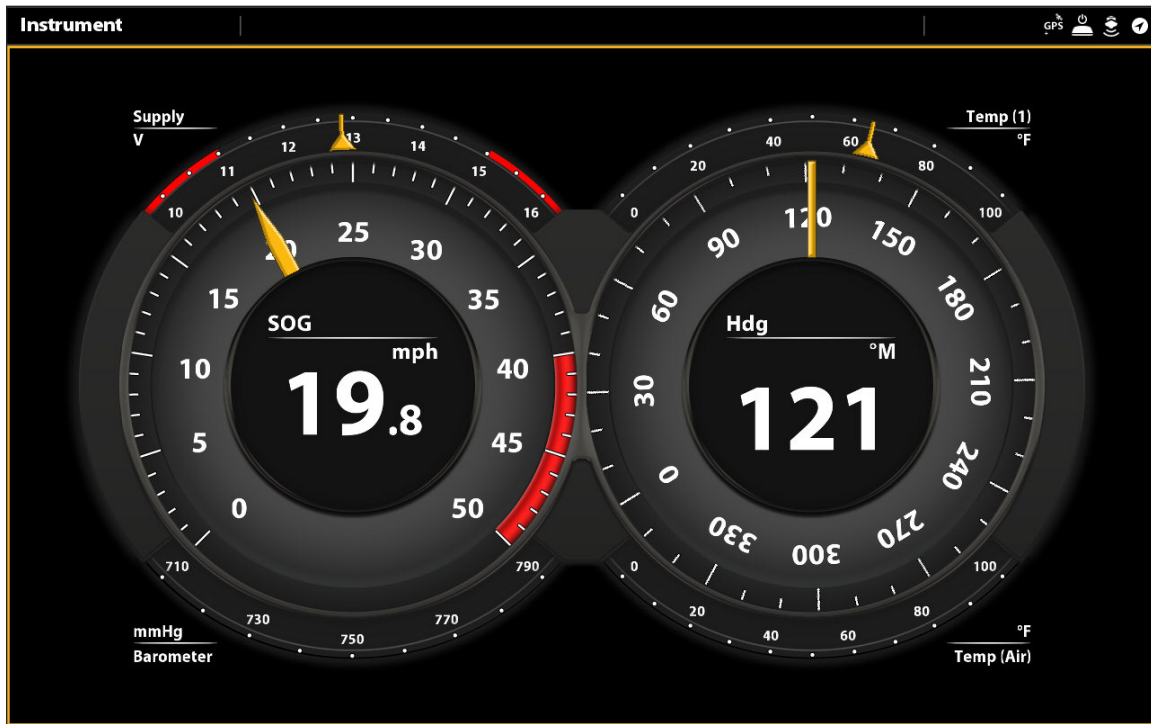

Display an Instrument View

Touch Screen

1. Press the HOME key.
2. Select the Views tool.
3. Under Groups, select Instrument.
4. Tap an Instrument View.
5. Tap Instrument in the status bar.
6. Select Dashboard or Engine.

Keypad

1. Press the HOME key.
2. Select the Views tool.
3. Under Groups, select Instrument.
4. Use the Joystick to choose an Instrument View. Press the Joystick.
5. Press the MENU key.
6. Select Dashboard or Engine.

Customize an Instrument View

In an Instrument View, you can customize the gauges, data boxes, and ranges. You can change each item in the same way you change data boxes in a view. You can also set up warning limits for the selected data range.

 **NOTE:** The available changes and sources are determined by the selected gauge or data box. As you change data, the available sources are displayed in white, and the unavailable sources are displayed in black.

Touch Screen

1. With an Instrument View displayed on-screen, tap Instrument in the status bar.
2. Select Edit Instrument.
3. Tap a gauge or data box.
4. **Change the Type of Data:** Select Data Type. Select a category and a data type from the menus.
5. **Change the Displayed Range:** Select Data Limits. Select a range from the list.

Set the Warning[s] Threshold: Select a warning (if available), and tap the on/off button to turn it on. Press and hold the slider to set the warning threshold.

6. **Close:** Press and hold the EXIT key.

Keypad

1. With an Instrument View displayed on-screen, press the MENU key.
2. Select Edit Instrument.
3. Use the Joystick to select a gauge or data box. Press the ENTER key.
4. **Change the Type of Data:** Select Data Type. Select a category and a data type from the menus.
5. **Change the Displayed Range:** Select Data Limits. Select a range from the list.

Set the Warning[s] Threshold: Select a warning (if available), and press the ENTER key to turn it on. Turn the Rotary dial to set the warning threshold.

6. **Close:** Press and hold the EXIT key.

Selecting a Gauge



Selecting a Radial Gauge

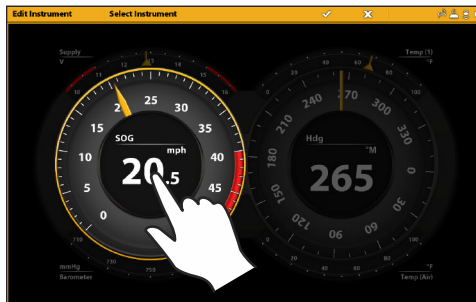

Selecting a Data Box

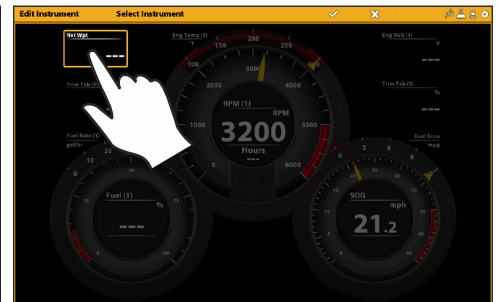

Press and Hold

OR

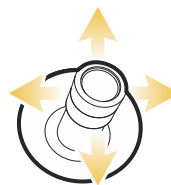

Select



Open

CHART OVERVIEW

To enable the navigation features, the control head must have a GPS fix from an internal or external GPS receiver [see **Getting Started** to check the sensor reception]. Some of these features also require a compass/heading sensor to be connected to the control head.

The selected map source also influences the menu system. When you change the map source, the menu options for the Chart Views change, allowing you to add navigation data, shading, or alarms.

2D Chart View (Humminbird)

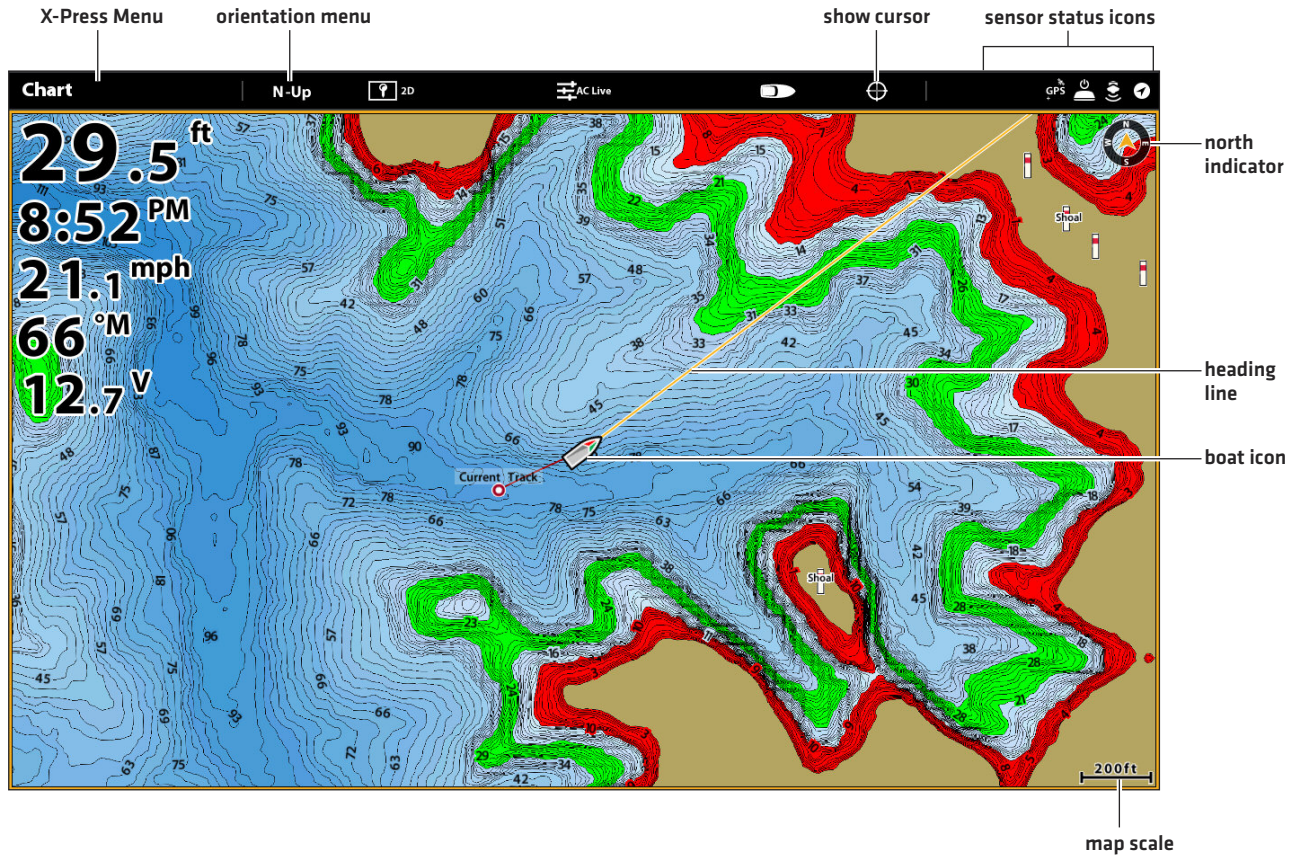

MAP SOURCE

The SOLIX includes built-in charts by Humminbird and Navionics. You can also install SD cards with additional chart information for a particular location [separate purchase required].

Humminbird is the default map source, but you can change the map source at any time. When you install an SD card, the control head automatically chooses the best map to display. If you install more than one SD card, you can choose which map source you want to use.

Compatible Map Sources: Humminbird LakeMaster, AutoChart, SmartStrike, ChartSelect, and Navionics. Visit our Web site at humminbird.com for compatibility details.

Install an SD Chart Card

Load Maps

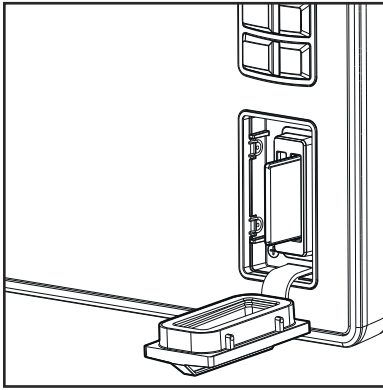

Insert the SD card with the label facing left

Install an SD Card

1. Insert the card into the slot with the label facing left.
2. The control head automatically chooses the best chart to display. If more than one type of SD card is installed, follow the on-screen prompts to select the map source.

Eject an SD Card

1. Press the SD card into the slot and release. Pull the card from the slot.



WARNING! Do not leave the SD slot cover open. The slot cover should always be closed to prevent water damage to the unit.

Change the Map Source

When you install an SD card, the map source is changed automatically to match the SD card map source. You can also change the map source using the Settings tool.

When you change the map source, the menu options for the Chart Views also change, allowing you to add navigation data, shading, alarms, and more. See each section for details.

1. Press the HOME key.
2. Select Settings.
3. Select Chart.
4. Select a Map Source.

Selecting a Map Source

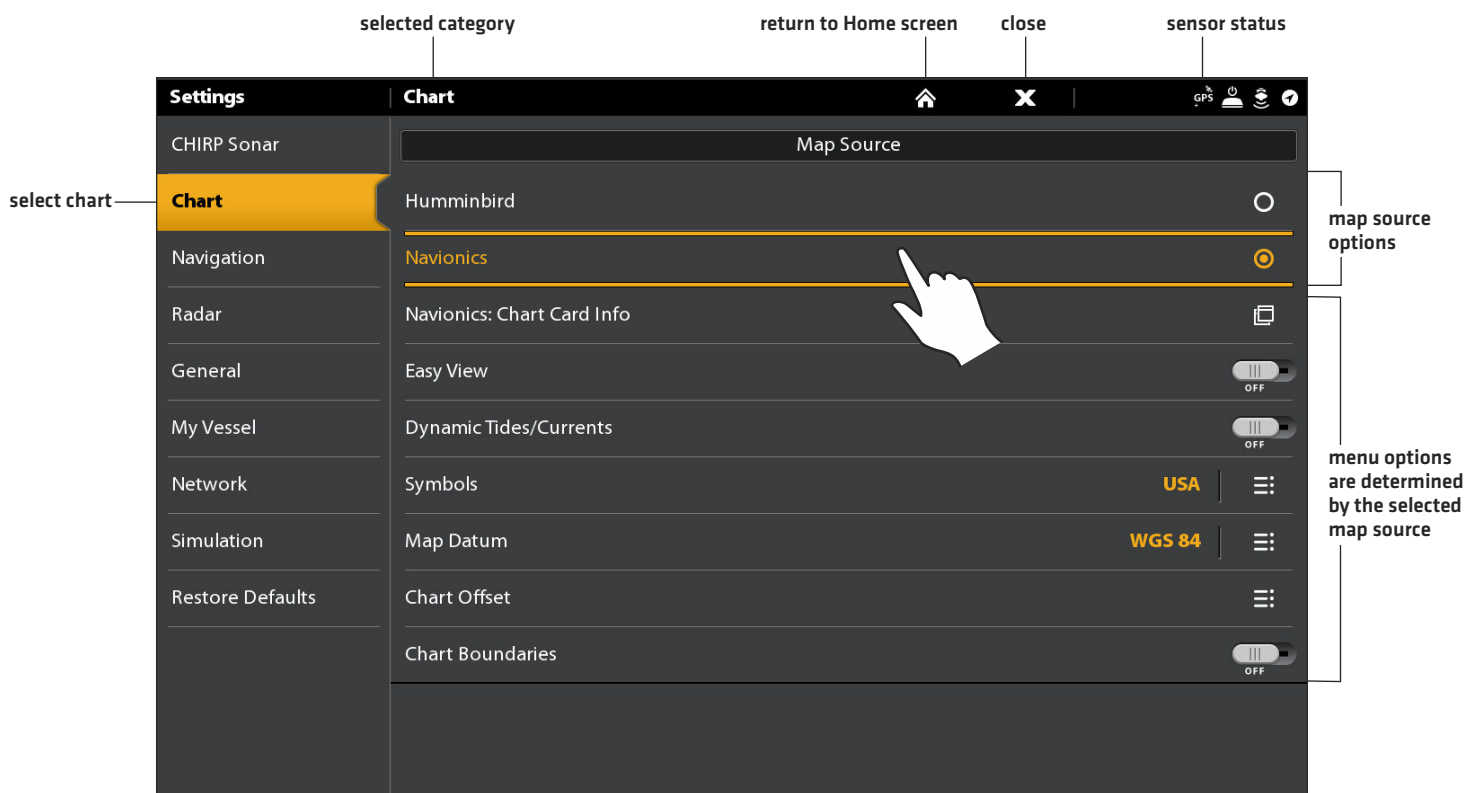

Tap to Select

OR

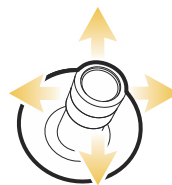

Select



Confirm

Set up Humminbird

When Humminbird is selected as the map source, you can use the system defaults, or you can set the menu settings to your preference. You can use the built-in Humminbird map, or you can install an SD chart card with additional Humminbird LakeMaster features.

1. Select Humminbird as the map source.
2. Set the following menus to your preference:

Humminbird: Chart Card Info	Select this menu to review the information about the installed Humminbird chart card.
Water Level Offset	Adjust the setting to change the water level read by the control head. For example, if the lake is down 5 feet, set the Water Level Offset setting to -5. The displayed numbers on the Contour Lines will adjust from the Water Level Offset setting, and the water level offset will be highlighted in brown to extend the land visually on the display. To apply depth colors, depth highlight range, etc., go to the Chart X-Press Menu > Chart Options > Humminbird Settings. See <i>Open the Chart Preferences Menu</i> for more information.



NOTE: There are also alarm and display options that are exclusively available for Humminbird LakeMaster charts. See **Navigation Alarms Overview** and **Customize the Chart View** for more information.

2D Chart View (Humminbird)

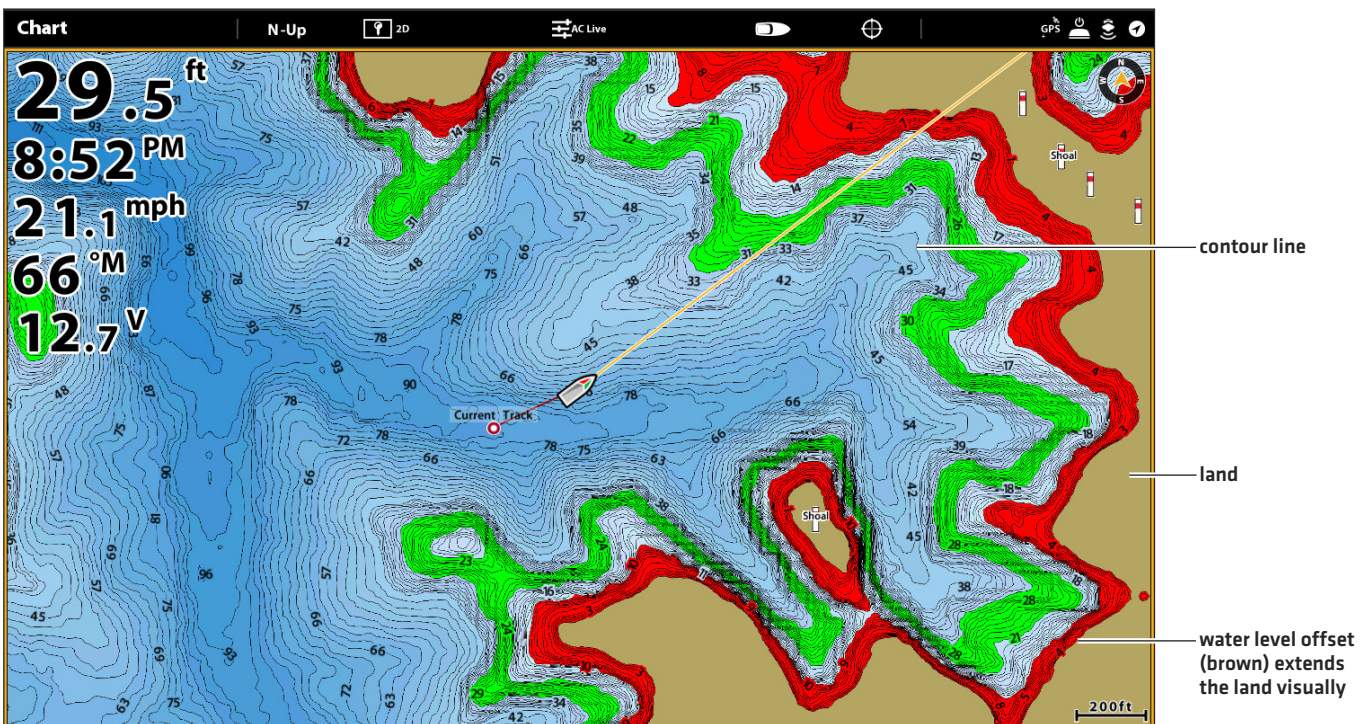

Set up Navionics

When Navionics is selected as the map source, you can use the system defaults, or you can set the menu settings to your preference. You can use the built-in map, or you can install an SD chart card with additional features.

1. Select Navionics as the map source.
2. Set the following menus to your preference:

Navionics: Chart Card Info	Select this menu to review the information about the installed Navionics chart card.
Easy View	Turn on Easy View to simplify the Chart View. The icon size and text size increase for easier viewing.
Dynamic Tides/Currents	Turn on Dynamic Tides/Currents to display an icon on the Chart View that indicates the status of the tides and currents. The provided data is affected by the station's time zone.
Symbols	Select USA or International symbols to display on the Chart View.
Map Datum	Use Map Datum to change the map coordinate system used by the control head to match those of a paper map. Almost all electronic charts use the WGS84 Map Datum and most likely do not require a setting change. [Default = WGS84]
Chart Offset	Use Chart Offset to move the chart position on-screen and correct a position error in the cartography. Turn on Chart Offset, and use the sliders to adjust the latitude/longitude coordinates. The Chart Offset setting applies to all charts, not just the chart that requires correction.
Chart Boundaries	Turn on Chart Boundaries to display chart boundaries on the Chart View. The dotted lines of a chart boundary indicate an area that contains a different map. Use the Joystick to move the cursor within a chart boundary, and press the +ZOOM key to see a closer view of the chart.



NOTE: There are also alarm and display options that are exclusively available for Navionics charts. See **Navigation Alarms Overview** and **Customize the Chart View** for more information.

2D Chart View [Navionics]

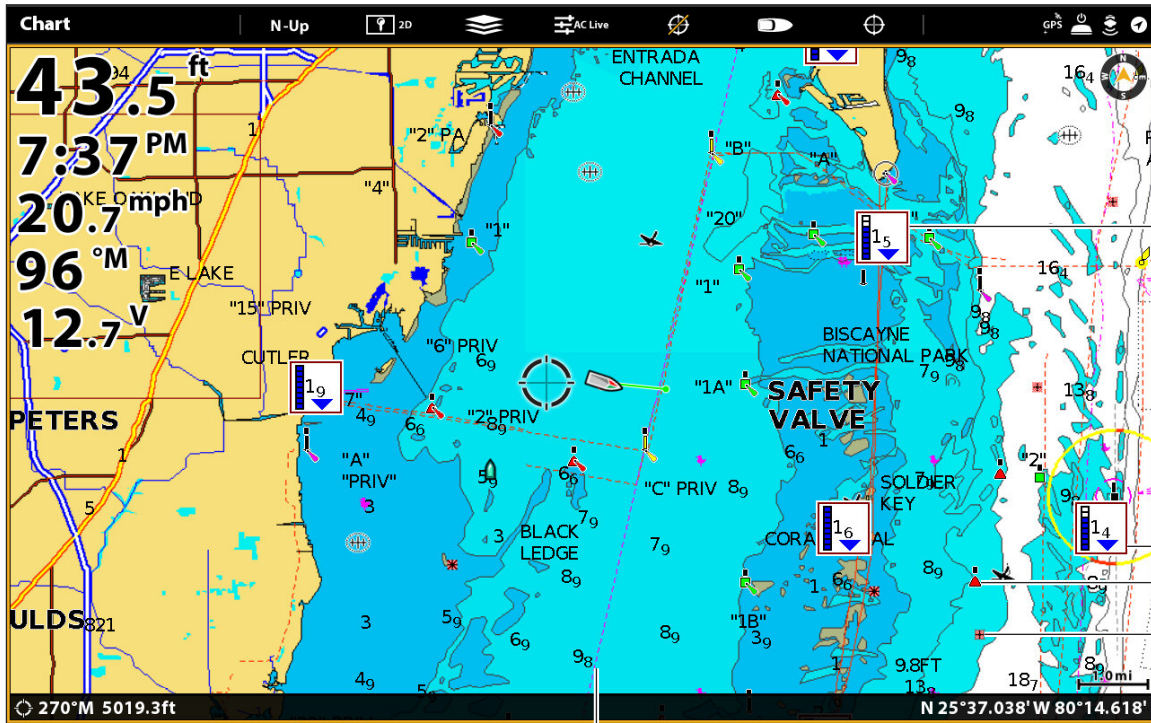

dynamic tides/currents icon

symbols

chart boundary

NAVIGATION ALARMS OVERVIEW

When an alarm is turned on, an alert will sound or display on the control head to indicate the threshold has been exceeded. The settings in this section describe how to turn on a Navigation alarm, adjust the threshold, and display the limits on the view if they are available. The alarm options are determined by the map source.

 **NOTE:** To turn on additional alarms that relate to your vessel and navigation, such as Lost Heading, Drift Alarm, Pitch, Roll, and more, select Home > Alarms > System and Home > Alarms > Vessel.

Chart View with Alarm Overlays Displayed (Humminbird)



Off Course (XTE) Alarm

Turn on Off Course [XTE] to receive an alert if the vessel has traveled outside the selected route. You can also set how far the vessel is allowed to move off course before the alarm is triggered. If the alarm is turned off, the Off Course limit can be displayed on the Chart View, but you won't receive an alert if the vessel crosses it.

Turn on the Alarm

1. Press the HOME key.
2. Select Alarms > Navigation.
3. Select Off Course [XTE]. Tap the on/off button, or press the ENTER key, to turn it on.

Adjust the Parameters (optional)

1. Press the HOME key.
2. Select Settings > Navigation > Off Course [XTE].
3. Press and hold the slider, or press and hold the ENTER key, to set the amount the vessel can move off course.

Display the Off Course (XTE) Limit (optional)

1. With a Chart View displayed on-screen, tap Chart in the status bar, or press the MENU key.
2. Select Chart Options > Overlays > Nav Data.
3. Select XTE Limits.
4. Tap the check box, or press the ENTER key, to add a check mark and make it visible on the view.

Arrival Alarm

Turn on Arrival to receive an alert when the vessel has reached the destination waypoint, route point, or track point. You can also set the Arrival Radius to indicate how close to the destination point the alarm is triggered. If this alarm is turned off, the Arrival Radius will be displayed on the Chart View, but you won't receive an alert if the vessel crosses it.

The Arrival Radius also influences navigation. If the Arrival Radius is set to 60 feet from the destination point, the arrival is accomplished at 60 feet from the destination point. If there is another point in the route, navigation will then start to the next point.

Turn on the Alarm

1. Press the HOME key.
2. Select Alarms > Navigation.
3. Select Arrival. Tap the on/off button, or press the ENTER key, to turn it on.

Adjust the Parameters (optional)

1. Press the HOME key.
2. Select Settings > Navigation > Arrival Radius.
3. Press and hold the slider, or press and hold the ENTER key, to adjust the radius.

Waypoint Avoidance Alarm

Turn on Waypoint Avoidance to receive an alert if the vessel has crossed the Waypoint Avoidance Radius. If the alarm is turned off, the Waypoint Avoidance Radius can be set for a waypoint, and it will be displayed on the Chart View, but you won't receive an alert if the radius is crossed.

Turn on the Alarm

1. Press the HOME key.
2. Select Alarms > Navigation.
3. Select Waypoint Avoidance. Tap the on/off button, or press the ENTER key, to turn it on.

Create an Avoidance Waypoint

1. See *Waypoints: Set the Waypoint Radius and Avoidance* to identify a waypoint for avoidance.

Anti-Collision Alarm

If Navionics is selected, and the Anti-Collision alarm is turned on, an alert will be provided based on potential dangers detected in the chart data ahead of the vessel, such as land, rocks, and restricted areas. You can also select Anti-Collision Objects and how far in front of the vessel the area will be scanned based on distance or time.



NOTE: Navionics must be selected as the map source to enable this feature.

Chart View with Anti-Collision Overlay Turned On [Navionics]

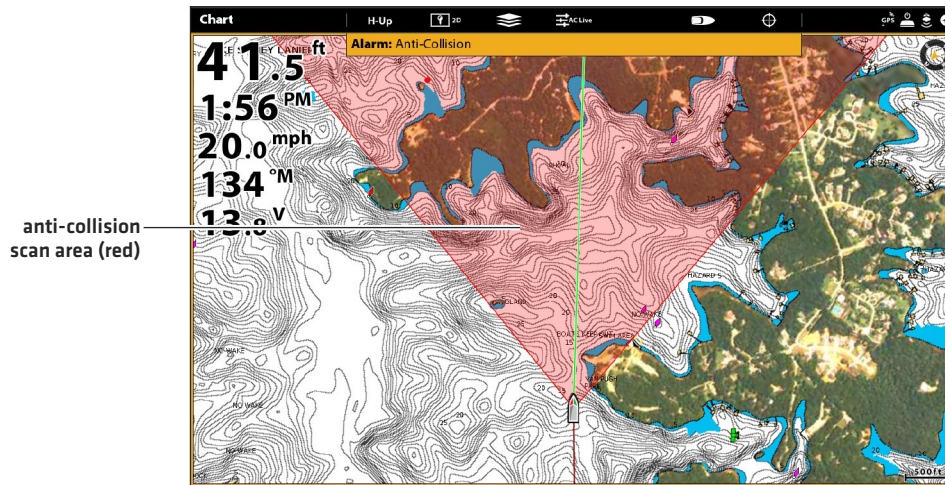

Turn on Anti-Collision

1. Press the HOME key.
2. Select Settings > Navigation.
3. Select Anti-Collision. Tap the on/off button, or press the ENTER key, to turn it on.

Use the Anti-Collision default settings, or use the menus in this section to set how the area is searched [Search Parameters, Search [Time] or Search [Distance], and Anti-Collision Objects].

Turn on the Alarm

1. Press the HOME key.
2. Select Alarms > Navigation.
3. Select Anti-Collision Alarm. Tap the on/off button, or press the ENTER key, to turn it on.

Display the Anti-Collision Overlay

When the overlay is turned off, the scan area is shown only when a danger is detected.

When the overlay is turned on, the scan area is displayed at all times. When a potential danger is detected, the scan area will turn red.

1. With a Chart View displayed on-screen, tap Chart in the status bar, or press the MENU key.
2. Select Chart Options > Overlays > Vessel.
3. Select Anti-Collision.
4. Tap the check box, or press the ENTER key, to add a check mark and make it visible on the view.

MAN OVERBOARD (MOB)

As soon as you know that you have a man overboard (MOB), you should activate Man Overboard navigation to maximize the chances for a successful rescue. Man Overboard navigation marks the approximate point where the person went overboard and starts continuous navigation toward the Man Overboard waypoint.

Activate Man Overboard Navigation



1. Press and hold the MARK/Man Overboard key.

Man Overboard Navigation

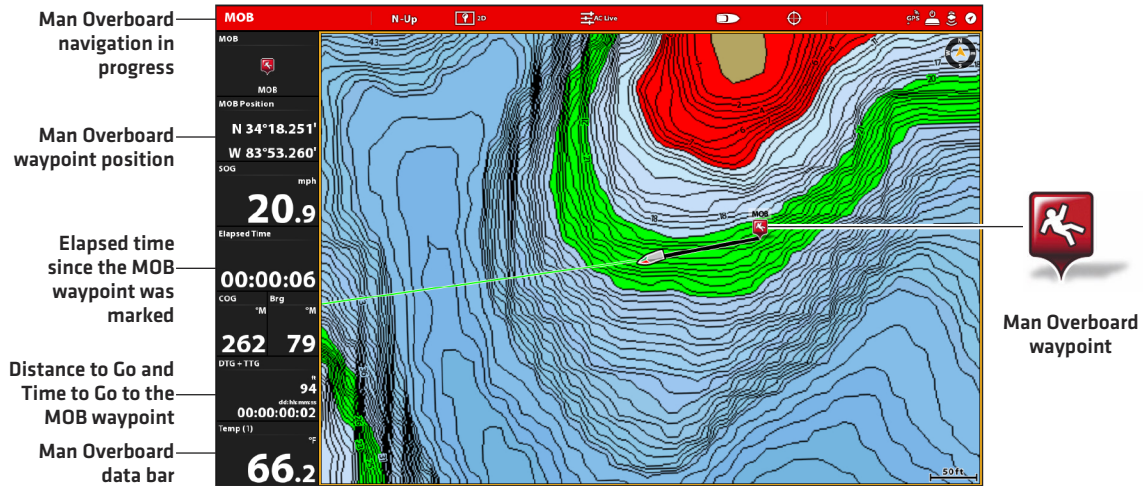

When Man Overboard is activated, any current navigation will be canceled and the current route will be discarded without notification. Man Overboard navigation will begin immediately, and you will see the following on the screen:

Chart View: The view will switch to Chart View automatically.

Man Overboard Waypoint: A waypoint is created at the vessel's current position, regardless of whether the chart cursor is active or not.

Continuous Navigation: The control head will begin continuous navigation toward the Man Overboard waypoint.

Auto Zoom: The screen magnifies to show the Man Overboard waypoint and the vessel on the screen.

Data Bar: The data bar will display digital readouts for Man Overboard, including the Man Overboard Waypoint latitude/longitude position, the elapsed time since Man Overboard was activated, and the Distance to Go and Time to Go to the MOB waypoint (DTG + TTG).

Cancel Man Overboard Navigation

1. Press and hold the MARK/Man Overboard key. Select Cancel Navigation.

OR

Press the GO TO key. Select Cancel Navigation.

CUSTOMIZE THE CHART VIEW

The settings in this section are optional. You can use the default settings for the chart appearance and map source, or you can customize the Chart View for your navigation preferences. See **Views** for more information.

OPEN THE HUMMINBIRD SETTINGS MENU

When Humminbird LakeMaster is selected as the map source, additional menus to customize the Humminbird chart display are added to the menu system.

1. With a Chart View displayed on-screen, tap Chart in the status bar, or press the MENU key once.
2. Select Chart Options.
3. Select Humminbird Settings.



Shortcut Menu: Some menus will be displayed as shortcuts under the X-Press Menu. Any menu setting changes will be applied in both menu locations. See the illustration below.

Opening the Humminbird Settings Shortcut Menu

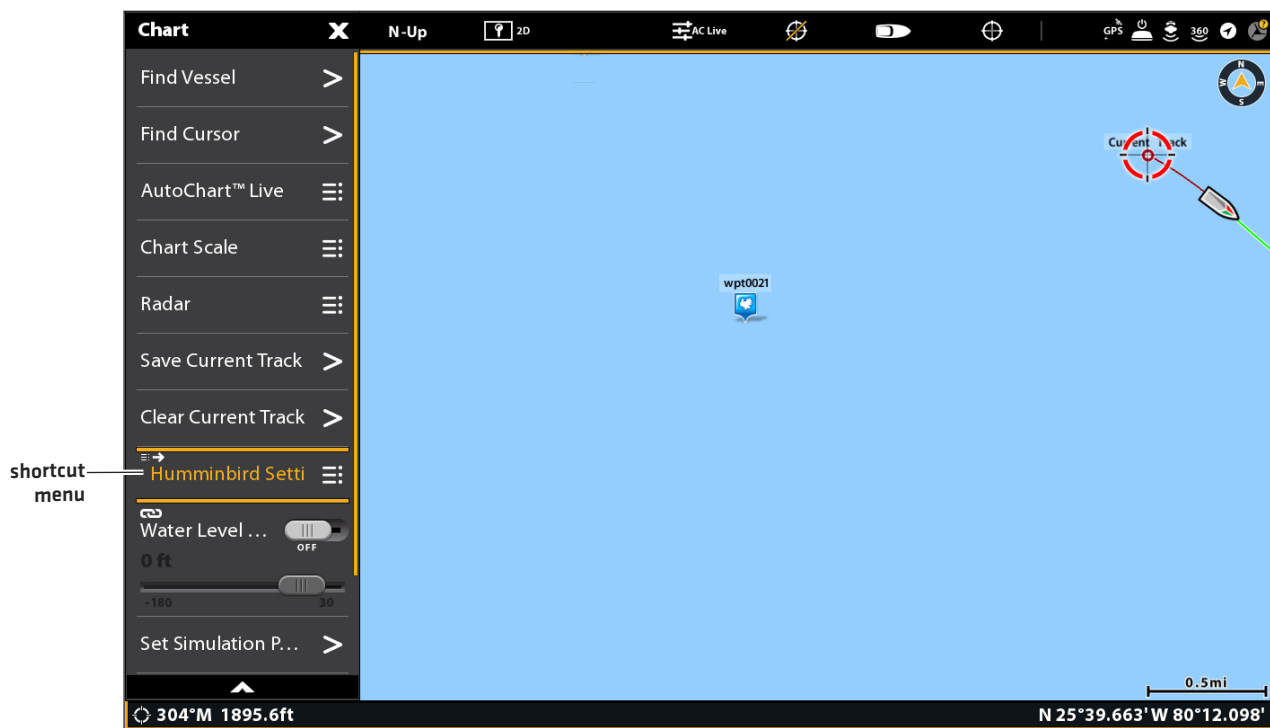

Adjust the Depth Range and Colors



NOTE: Humminbird must be selected as the map source to enable this feature.

1. From the Humminbird Settings menu, select the settings shown in the table below.

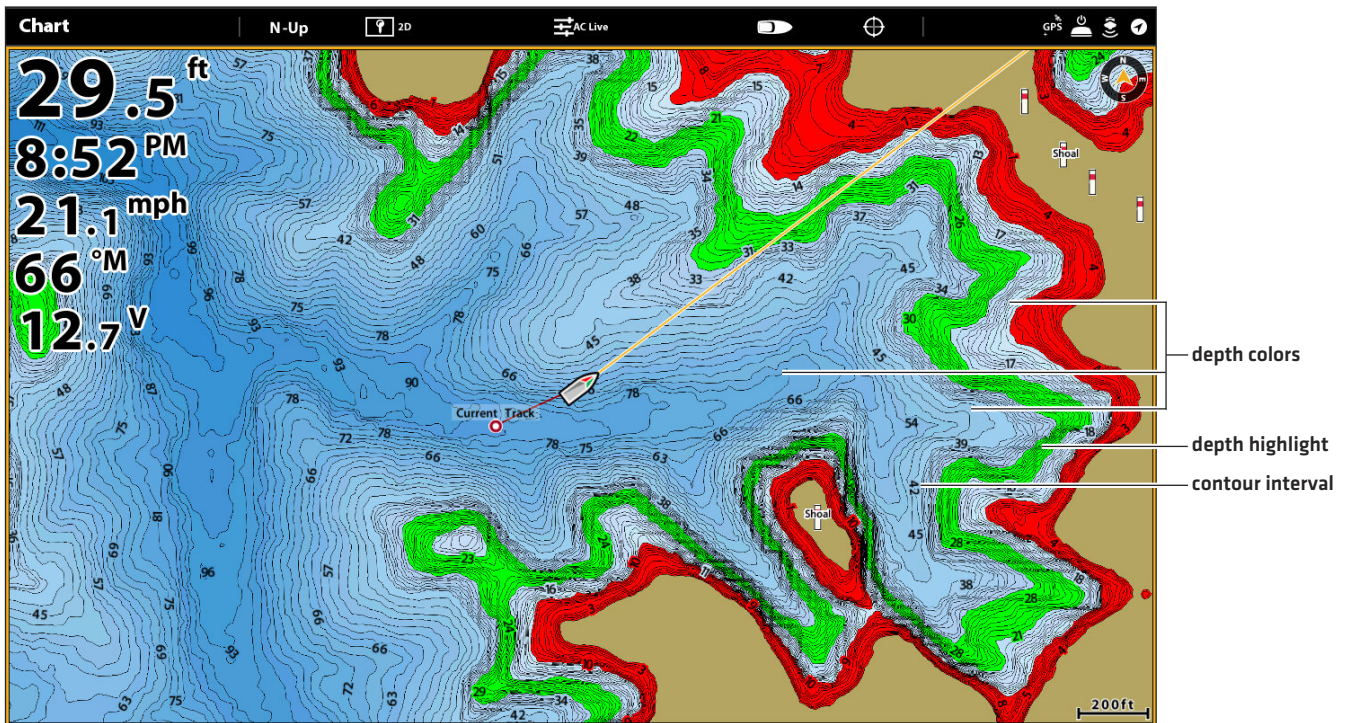

Depth Colors	Turn on Depth Colors and adjust the range for depth shading in the Chart Views.
Depth Highlight	Turn on Depth Highlight to highlight a depth setting in the Chart Views. The depth you set will be highlighted in green. Use Depth Highlight with Highlight Range.
Highlight Range	When a Depth Highlight is active in the Chart Views, use Highlight Range to highlight a range on each side of the highlighted depth. For example, if you know a certain fish is holding at 18 to 20 feet, you can set the Depth Highlight at 19 feet, and the Highlight Range a +/- 1 foot. The view will show a green band from 18 to 20 feet.
Shallow Water	Turn on Shallow Water and adjust the slider. When the depth is equal to or less than the amount set, it will be highlighted in red in the Chart Views. For example, if your boat has a draft of 3 feet, set the Shallow Water menu to 3 feet, and the unit will draw a red band from 0 to 3 feet.
Contour Interval	Turn on Contour Interval to display lines at set intervals on the Chart View. Adjust the slider to set the distance between each line. Contour Interval is also affected by the Water Level Offset setting. See <i>Map Source: Set up Humminbird</i> .

Set the Chart Orientation

Use the Preferences menu to change the chart orientation.

1. With a Chart View displayed on-screen, tap Chart in the status bar, or press the MENU key once.
2. Select Chart Options > Preferences > Orientation.
3. Select an orientation to apply to the chart.



QUICK TIP! You can also select the Chart Orientation Menu on the status bar. See the illustration below.

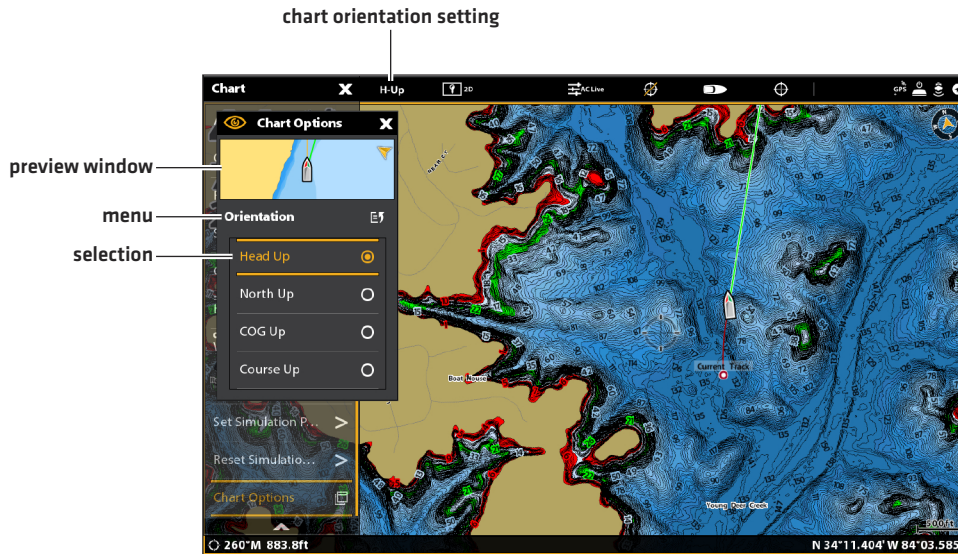

<p>Head Up [compass or GPS required]</p>	<p>The vessel's current heading points up, and the chart rotates around the vessel icon so that it always points up on the view. The heading is provided by the connected compass/heading sensor. If a compass is not connected, the vessel will be oriented according to the COG [Course Over Ground].</p>
<p>North Up</p>	<p>The chart is oriented with North up on the display, and the vessel rotates according to its heading or COG [Course Over Ground].</p>
<p>COG Up</p>	<p>The chart is displayed with the vessel oriented in a fixed position pointing up, and the chart rotates according to the vessel COG [Course over Ground].</p>
<p>Course Up</p>	<p>During navigation, the intended course or route leg is shown at the top of the view. Objects ahead of the vessel are drawn above the vessel. When the vessel is not navigating, the current heading is displayed.</p>

Set the Motion Mode

Motion Mode controls how the chart moves on the view. This menu is available in Custom Mode [see *The Menu System: Change the User Mode*].

1. From the Preferences menu, select Motion Mode.
2. Select Relative or True.

Relative	The position of the vessel is fixed on the view and the chart moves with the vessel.
True	The chart is fixed and the vessel moves towards chart objects on the view.

Turn on/off Vessel Offset

Vessel Offset allows you to see more of the view based on the speed of the vessel. Vessel Offset works with Auto Shift Speed.

1. From the Preferences menu, select Vessel Offset.
2. Select Off, On, or Auto.

Off	The vessel is displayed in the center of the Chart View.
On	The vessel is displayed on the lower part of the Chart View.
Auto	When the vessel is moving below the Auto Shift Speed setting, the vessel icon will be displayed in the center of the view. When the vessel is moving at or above the Auto Shift Speed setting, the vessel icon will move to the edge of the view so that more of the view is shown on-screen.

3. **Close:** Press the EXIT key until the menu is closed.
4. To change the Auto Shift Speed Setting, press the MENU key twice. Select My Vessel > Auto Shift Speed.

Turn on Auto Zoom

Auto Zoom focuses the view on the current route leg as it is being navigated. As the vessel's speed increases, the chart range will increase. If you press the ZOOM keys to see more or less of the view, Auto Zoom will pause.



NOTE: The Auto Zoom setting does not apply to the 3D Views.

1. Press the HOME key.
2. Select Settings.
3. Select Navigation.
4. Select Auto-Zoom. Tap the on/off button, or press the ENTER key, to turn it on.

Select Map Data

When a Navionics chart is selected as the map source, you can set nav aids, marine, and land icons to hidden or visible. The Depth menu option allows you to see shading on the map based on the set depth.



NOTE: Navionics must be selected as the map source to enable this feature. The menu options will change with the selected map source.

1. With a Chart View displayed on-screen, tap Chart in the status bar, or press the MENU key once.
2. Select Chart Options.
3. Select Navionics Settings.
4. Use the touch screen or the Joystick to select a menu and change the settings.

Chart View with Nav aids and Icons Displayed (Navionics)

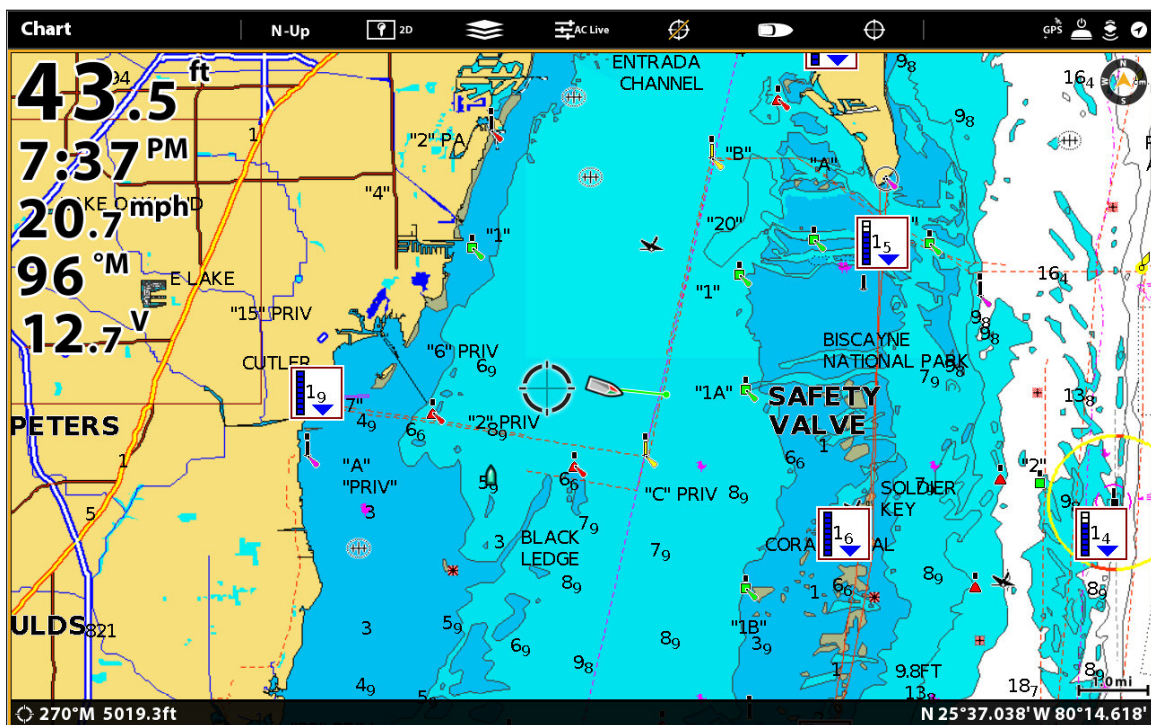

CHANGE THE CHART VIEW OVERLAYS

Use the Overlays menu to display or hide information on the view. In a Chart View, you can display or hide the vessel icon, navigation data [waypoints, routes, tracks], data overlays, AIS and MARPA targets, and range rings. The available menu options are determined by the accessories attached to the control head network. Also, see **Views** for more information about Overlays.

1. With a Chart View displayed on-screen, tap Chart in the status bar, or press the MENU key once.
2. Select Chart Options.
3. Select Overlays.
4. Use the touch screen or Joystick to select a menu and change a setting. [check mark = visible, blank = hidden].

Chart View with Overlays Displayed (Humminbird)

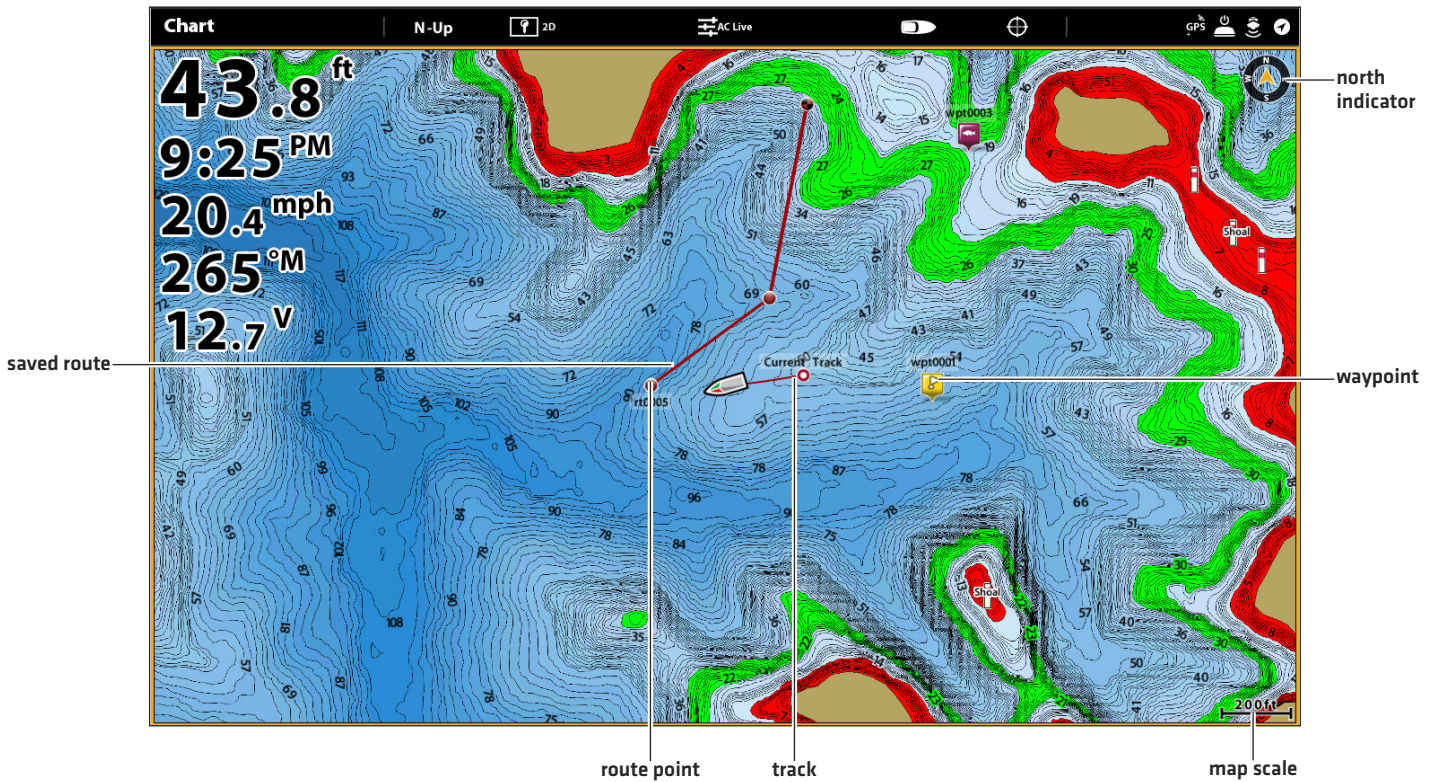

CHART AND RADAR

If a radar is connected to the control head network, the radar data can be displayed on the Chart View. To adjust the menu settings for the radar, see **Radar Overview** for more information.

Start Radar Transmission

1. **Humminbird CHIRP Radar:** Press the POWER key once. Select Radar > Standby. Press the POWER key again, and select Radar > Transmit.

Humminbird Radar: Press the POWER key once. Select Radar Transmit, and turn it on.



NOTE: For more information about Humminbird CHIRP Radar and Humminbird Radar, see **Radar Overview**.

Display Radar on the Chart View

1. With a Chart View displayed on-screen, tap Chart in the status bar, or press the MENU key once.
2. Select Radar.
3. Select Radar Overlay. Tap the on/off button, or press the ENTER key, to turn it on.



NOTE: You can also display Range Rings and MARPA Targets on the Chart View. See **Change the Chart View Overlays** in this section for more information.

Turning on the Radar Overlay

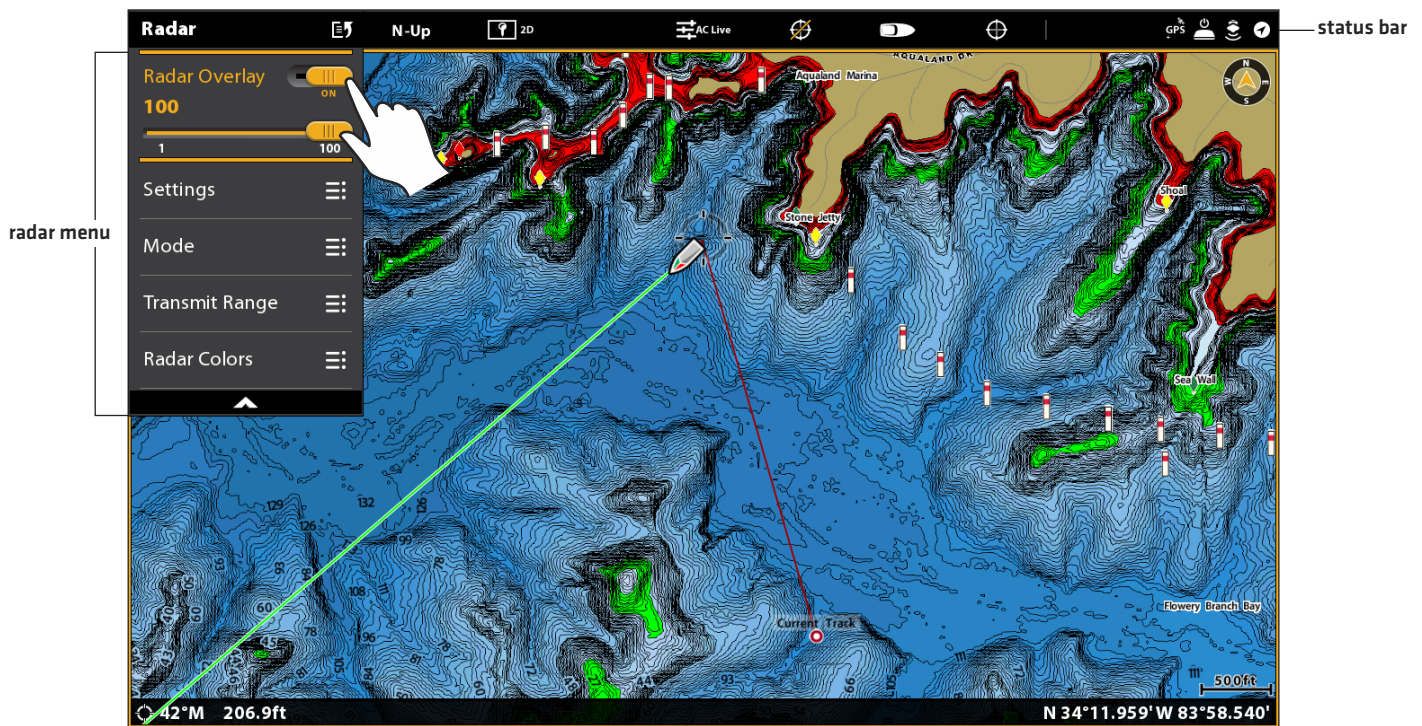

Use the instructions in this section to switch the Chart View from 2D to 3D.



NOTE: Navionics must be selected as the map source to enable this feature.

Change the Chart Mode

Touch Screen

1. With two fingers, tap the screen twice.

OR

1. Tap Chart in the status bar.
2. Select Chart Mode.
3. Select a menu option.

Keypad

1. Press the MENU key.
2. Select Chart Mode.
3. Select a menu option.

INTRODUCTION TO NAVIGATION

Your Humminbird control head allows you to mark waypoints, create a route, and start navigating. Waypoints, routes, and tracks can be managed on-screen so you can save your favorites, edit names, and easily return to your favorite destinations.

There are many ways to start navigation or edit navigation data with your Humminbird control head. The instructions in this section review navigation features on the Chart View. To use navigation features from the Nav Data tool, see *Manage your Navigation Data*.



NOTE: To start navigation from your control head to your autopilot, see the autopilot section of this manual.

Chart View with Waypoints, Routes, Tracks

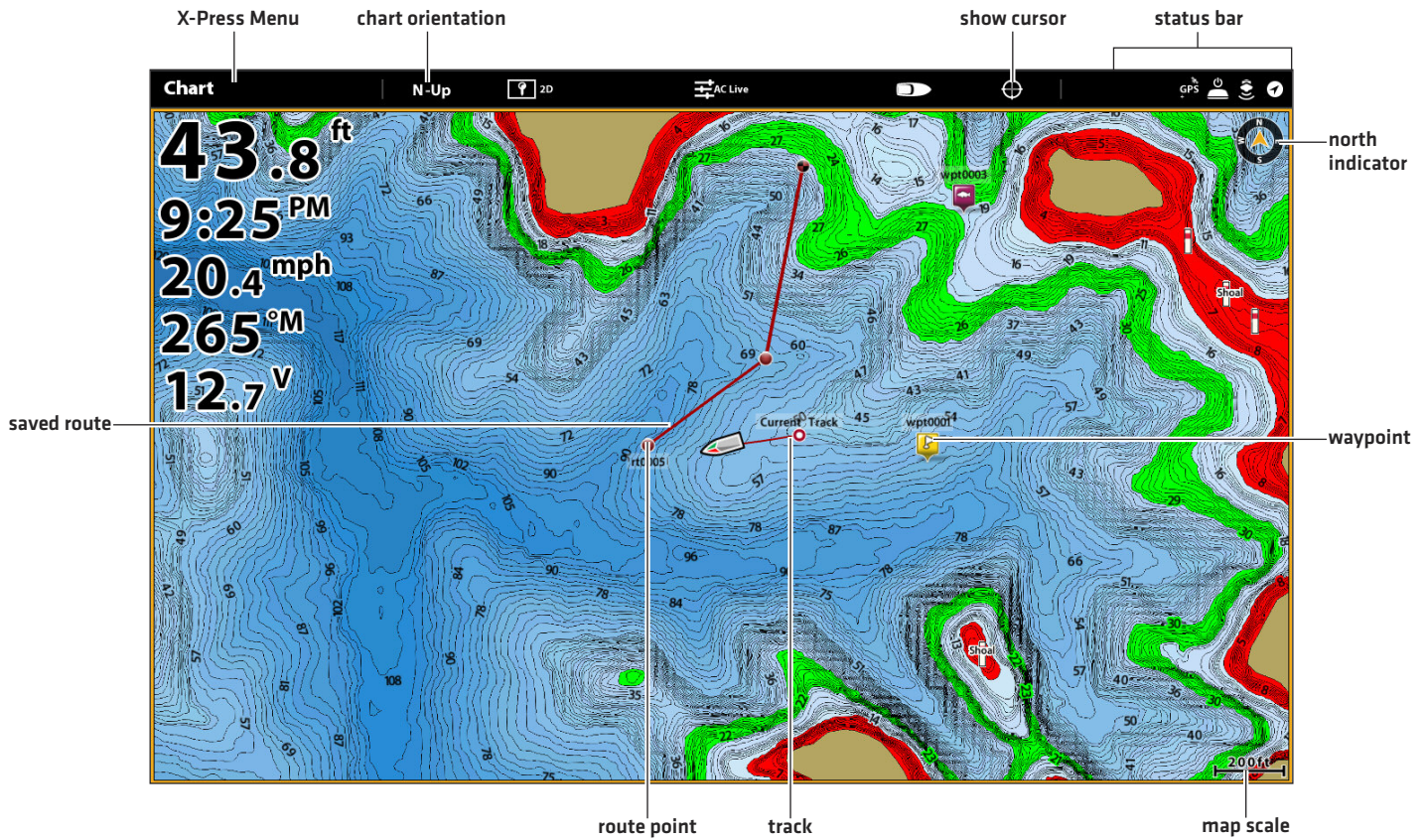

Tap to Activate the Cursor

OR

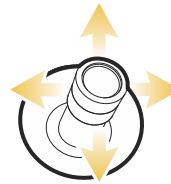

Move the Joystick to Activate the Cursor

NAVIGATION MENU OVERVIEW

There are many ways to use the navigation features on your control head. The Navigation X-Press Menu and Cursor menu are opened using the touch screen. The same menus are also opened by pressing the MARK key, GO TO key, or ENTER key.

This section is an overview of the menus available for navigation. The availability of menu options is determined by the navigation mode and your Humminbird model. To apply these functions, see **Waypoints, Routes, Tracks, and Search**.

Navigation X-Press Menu

The **Navigation X-Press Menu** allows you to open the following navigation menus: Mark, Go To, and Info. The Navigation X-Press Menu is only available in the Chart View, Sonar Views, or Radar View displayed on-screen with Navigation enabled.

Open the Navigation X-Press Menu

1. With a Chart View displayed on-screen, tap Chart in the status bar.
2. Select Mark, Go To, or Info.
3. Select an action from the submenu. For example, to mark a waypoint, select Mark > Waypoint.

Using the Touch Screen to Open the Navigation X-Press Menu

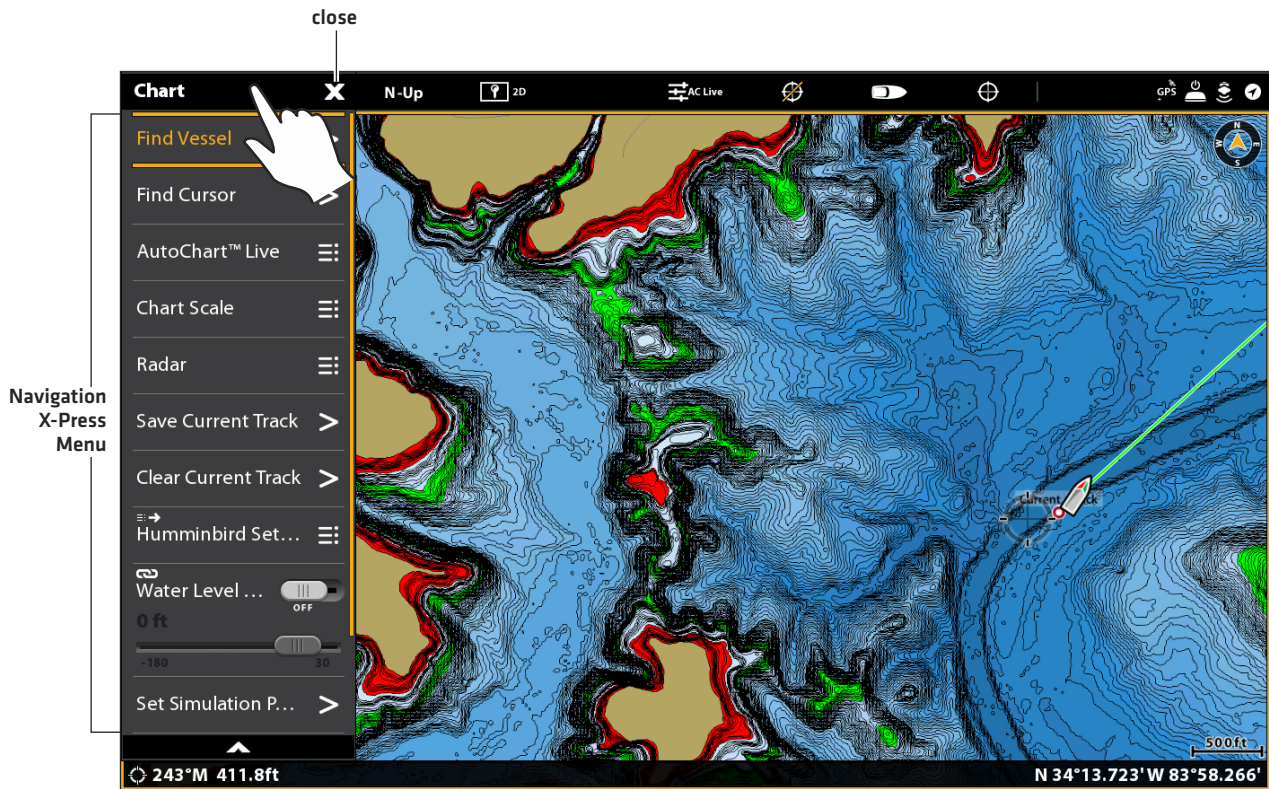

Mark Menu



The **Mark menu** marks a waypoint at the selected location. You can also create a saved route or mark the vessel position. See **Waypoints** and **Routes** for more information about using this menu.

Open the Mark Menu

1. **Touch Screen:** Select Mark from the Navigation X-Press Menu.

OR

Keypad: Press the MARK key.

Mark Menu Options

Mark Menu Options	
Waypoint	Select Waypoint to save a waypoint at the vessel position. If the cursor is active, the waypoint is saved at the cursor position.
Route	Select Route to create a saved route. See Routes for more information.
Lat/Long	Use the on-screen keyboard to manually enter a latitude/longitude position for a waypoint.
Vessel Position [with active cursor]	Select Vessel Position to save a waypoint at the vessel position even though the cursor is active.

Go To Menu

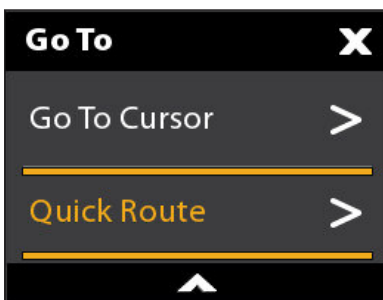

The **Go To menu** starts navigation to the item you select. See **Routes** for more information about using this menu.

Open the Go To Menu

1. **Touch Screen:** Select Go To from the Navigation X-Press Menu.

OR

Keypad: Press the GO TO key.

Go To Menu Options	
Quick Route	Select Quick Route to mark quick route points and start navigation. See Routes for more information.
Nav Data	Open the Nav Data tool to select saved navigation data and start navigation.
Lat/Long	Open the on-screen keyboard to enter a latitude/longitude position. Select Go To to start navigation to the position.
Go To Cursor	If the cursor is active, navigation will start to the cursor position.

When the Go To menu is opened during navigation, additional menu options are available, including the following:

Go To Menu Options (during navigation)	
Cancel Navigation	Select Cancel Navigation to cancel navigation with the control head.
Restart Course	Select Restart Course to start navigation from the current vessel position instead of from the first route point. The control head will recalculate navigation to the next closest point in the route. This is helpful if the boat has navigated off course from the current route.
Next Point	Select Next Point to skip the current point and navigate to the next route point in the route.
Reverse Route	Select Reverse Route to reverse the currently navigated route. Navigation will start from the vessel position and continue in the opposite order.

Info Menu

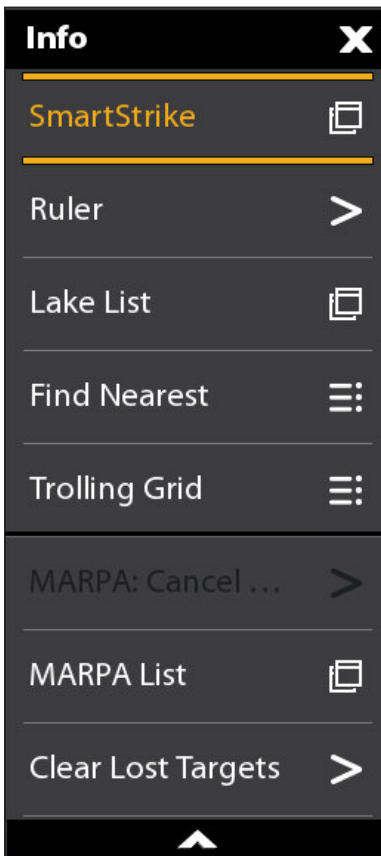

Use the **Info menu** to start a proximity search. You can also set a trolling grid from this menu.

If you are using Humminbird as the map source, you can search lake information. Navionics also has additional search options.

If you have Radar and AIS attached, use this menu to search targets [See *Radar Overview, AIS and MARPA*].

Open the Info Menu

1. **Touch Screen:** Select Info from the Navigation X-Press Menu.

OR

Keypad: Press the ENTER key.



NOTE: If you select a waypoint, route, or track with the cursor, and then press the ENTER key, the Info menu for the selected item will display.

Info Menu Options	
Info	Select Info to search the area within a preset range for a variety of data, including cautions, tide stations, current stations, and ports. The available information is determined by the selected map source and the information available in the search area. See Search for more information. [Navionics only]
Ruler	Select Ruler to measure the distance between two positions on the view. Press the ENTER key to select the measurement start point. Move the Joystick to the second selected position, and press the ENTER key to mark the measurement end point.
Lake List	Select Lake List to search for lakes within a preset range. Humminbird must be selected as the map source. See Search for more information.
Lake Name	Select Lake Name to open the on-screen keyboard and search for a lake by name. Humminbird must be selected as the map source. See Search for more information.
Find Nearest	Select Find Nearest to search the closest waypoints, routes, and tracks within a preset range. See Search for more information.
Trolling Grid	Select Trolling Grid to apply a trolling grid to a position on the Chart View. See Waypoints for more information.
AIS: All Inactive	Select this menu to change all tracked AIS targets to inactive [see AIS and MARPA].
AIS List	Select this menu to display a list of all AIS targets within the AIS transmission range [see AIS and MARPA].
MARPA: All Inactive	Select this menu to cancel all MARPA targets [see AIS and MARPA].
MARPA List	Select this menu to display a list of all MARPA targets [see AIS and MARPA].

Cursor Menu

The **Cursor menu** is another way to use the touch screen and mark a waypoint, create a route, or start a search. The Cursor menu is only available with the 2D Chart View, Sonar Views, or Radar View displayed on-screen.

Open the Cursor Menu

1. Press and hold a position on the Chart View.

Displaying the Cursor Menu

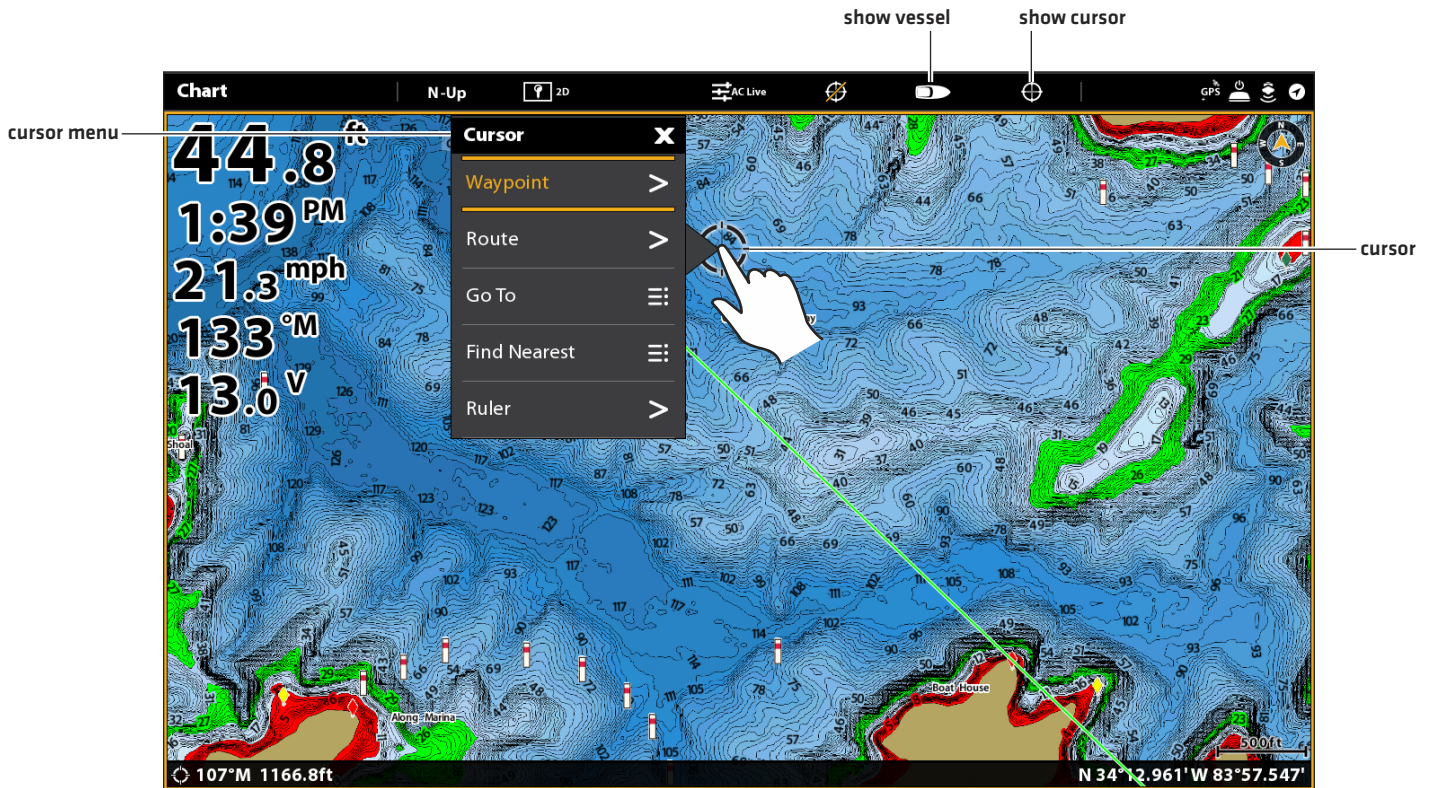

Press and Hold

WAYPOINTS



Waypoints are saved latitude/longitude positions. They mark a position of interest such as your favorite fishing area, structure, or marker buoy. The control head saves the position and allows you to edit the waypoint name, icon, and more [see *Manage your Navigation Data*]. You can save 10,000 waypoints to the control head.

Mark Waypoints

Waypoints can be marked at the vessel position or cursor position. To edit the waypoint, see *Edit a Waypoint in the Chart View* or *Manage your Navigation Data*. To display waypoints on the chart as they are marked, see *Change the Chart View Overlays*.

Mark a Waypoint at the Vessel Position

Touch Screen

1. Tap Chart in the status bar.
2. Select Mark.
3. Select Waypoint.

Keypad

1. Press the MARK key twice.

Mark a Waypoint at the Cursor Position

Touch Screen

1. Press and hold a position on the Chart View.
2. Select Waypoint.

Keypad

1. Use the Joystick to move the cursor to a position on the chart.
2. Press the MARK key twice.

Marking a Waypoint at the Cursor Position

The Mark menu opens when you press the MARK key or select Mark from the Navigation X-Press Menu.

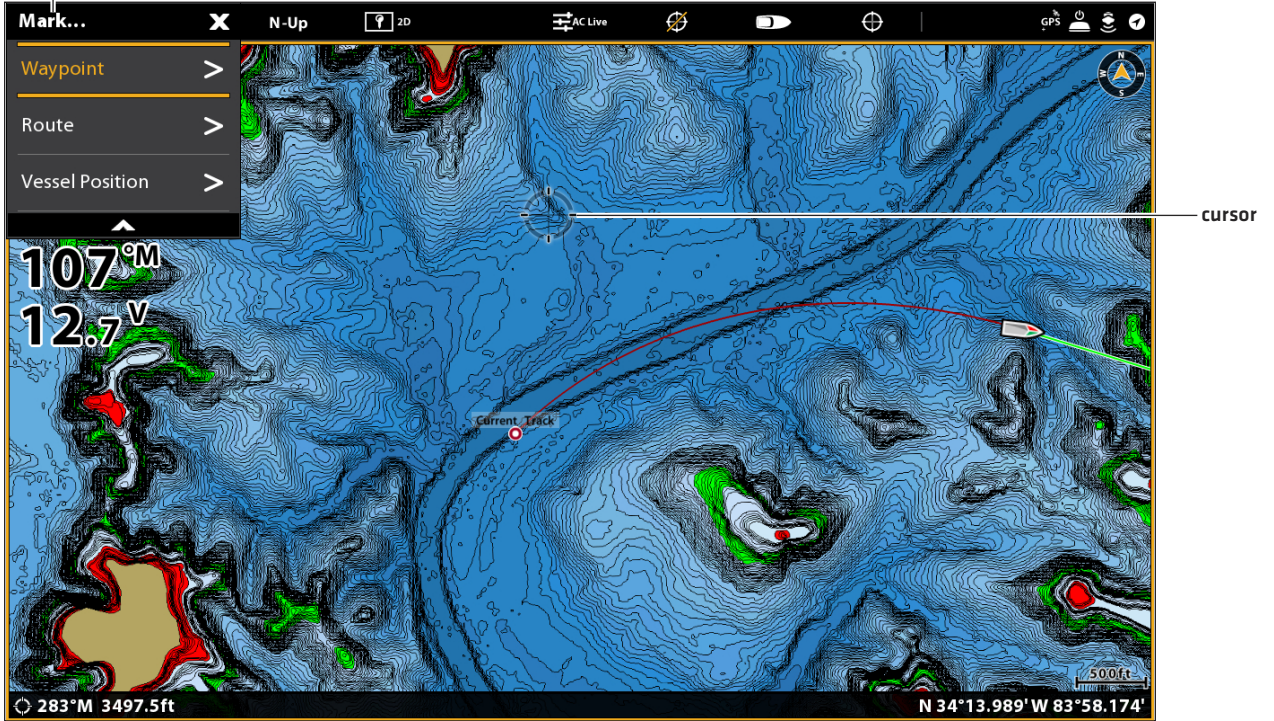

Press and Hold

OR

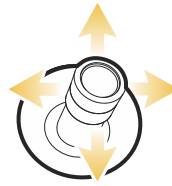

Move the Joystick
to Activate the Cursor



Press the
MARK key Twice

Mark + Edit Waypoints (on the go)

If you set the Mark Mode to Mark + Edit, you can edit a waypoint immediately when you mark it in the Chart View. See *Manage your Navigation Data* for more information.

1. Press the HOME key.
2. Select the Nav Data tool.
3. Under Options, select Waypoints.
4. Select Mark Mode > Mark + Edit.
5. Close the Nav Data tool and display a Chart View on-screen.

When you mark a waypoint, the Waypoint Info menu will be displayed so you can edit the waypoint.

Mark Favorite Waypoints (on the go)

If you set the Mark Mode to Mark Favorites, you can edit a waypoint immediately using your Favorites settings. The waypoints will be saved to the group you designate. See *Manage your Navigation Data* for more information.

1. Press the HOME key.
2. Select the Nav Data tool.
3. Under Options, select Waypoints.
4. Select Mark Mode > Mark Favorites.
5. Select the Back icon to return to the previous menu, or press the EXIT key.
6. Select Favorite Settings, and set your favorite icons, colors, group, etc.
7. Close the Nav Data tool and display a Chart View on-screen.

When you mark a waypoint, the Favorites menus will be displayed so you can edit the waypoint using the options you set in Favorite Settings.

Move a Waypoint in the Chart View

1. Use the Joystick to move the cursor to a waypoint on the chart.
2. Press the ENTER key.
3. Select Move.
4. The menu will close. Use the Joystick to move the waypoint to a new position.
5. Press the ENTER key to confirm the new position.

Edit a Waypoint in the Chart View

1. Tap the waypoint icon to select it. Tap the Waypoint Name.

OR

Use the Joystick to move the cursor to a waypoint icon. Press the ENTER key.

2. Use the Waypoint Info menu to edit the waypoint name, icon, color, and more (see *Manage your Navigation Data* for more information).

3. **Close:** Press the EXIT key.

Editing a Waypoint on the Chart View

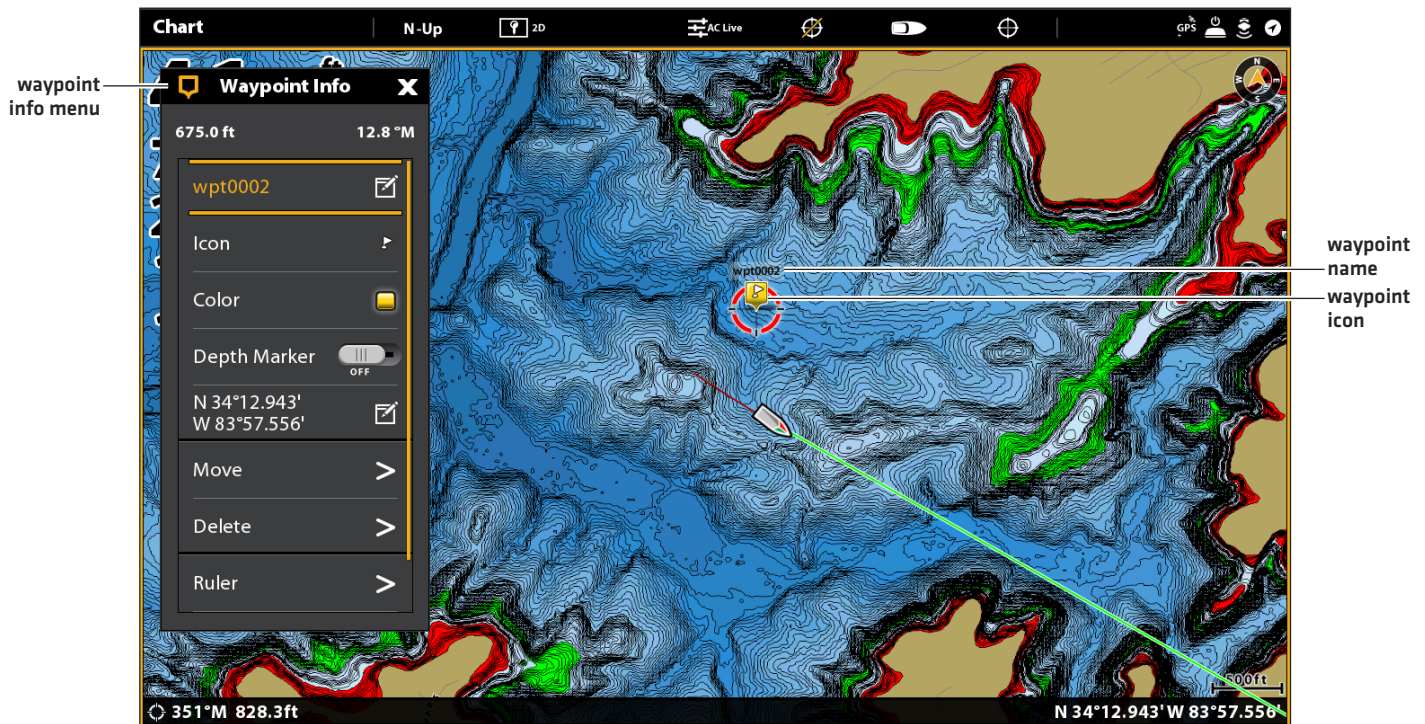

Create a Depth Marker

To save depth information with a waypoint, mark the waypoint at the vessel position. If the waypoint is marked at the cursor position, the depth information will not be available, but you can enter a depth manually. When Depth Marker is turned on, the Depth Marker icon is displayed on the Chart View.

1. Tap Chart in the status bar. Select Mark > Waypoint.

OR

Press the MARK key twice.

2. Select the Waypoint icon on the Chart View.

3. Press the ENTER key.

4. Select Depth Marker. Tap the on/off button, or press the ENTER key, to turn it on.

To change a depth marker back to a waypoint icon, turn off Depth Marker.



NOTE: If the waypoint was marked at the cursor position, select Full Info > Edit Depth. Use the on-screen keyboard to enter a depth. If you turn on Depth Marker, the depth you enter will be displayed.

Set the Waypoint Radius and Avoidance

A radius can be set around a selected waypoint. If you select Avoidance, the radius will be highlighted around the waypoint. To receive an alarm when the waypoint avoidance radius has been crossed, turn on the Waypoint Avoidance Alarm [see [Navigation Alarms Overview](#)].

1. Tap the waypoint icon to select it. Tap the Waypoint Name.

OR

Use the Joystick to move the cursor to a waypoint icon. Press the ENTER key.

2. Select Full Info.
3. Select Radius, and turn it on.
Press and hold the slider, or press and hold the ENTER key, to adjust the radius setting.
4. To set the waypoint to avoidance, select Avoidance. Tap the check box, or press the ENTER key, to add a check mark to it.
5. **Optional:** To receive an alarm when the radius has been crossed, turn on Waypoint Avoidance in the Navigation Alarms menu [Home > Alarms > Navigation > Waypoint Avoidance > On]

Display/Hide a Trolling Grid

The Trolling Grid applies a grid to the Chart View that can be used as a guide when trolling around a specific position. The trolling grid can be applied to any position on the chart.

1. Tap a position on the Chart View.

OR

Use the Joystick to move the cursor to a position on the Chart View.

2. Tap Chart in the status bar, or press the ENTER key.
3. Select Trolling Grid.
4. Use the menu options to set the grid size and rotation.

Display the Grid: Select Set Grid.

Remove the Grid: Select Remove Grid.

Delete a Waypoint in the Chart View

1. Tap the waypoint icon to select it. Tap the Waypoint Name.

OR

Use the Joystick to move the cursor to a waypoint icon. Press the ENTER key.

2. Select Delete.

ROUTES



Routes link two or more points together to create a path for navigation. A route represents your intended navigation and shows the shortest path from each data point to the next. The distance between each route point is a **route leg**. You can save 50 routes to the control head.



Route Points are stored latitude/longitude positions that connect to form route navigation.



Route Start Point



Route End Point



WARNING! You should always be aware of your surroundings and watch for any potential obstacles.

Quick Route Navigation

A Quick Route allows you to connect route points and waypoints and start navigation immediately. A Quick Route can be started with the GO TO key or with the touch screen. Quick Routes can be saved or discarded. To create a saved route, see **Create a Saved Route** or **Manage your Navigation Data**.

Start Quick Route Navigation

Touch Screen

1. Tap Chart in the status bar.
2. Select Go To.
3. Select Quick Route.
4. Tap the chart in the positions where you want to mark a route point.

Undo Last Route Point: Tap the Back icon.

Cancel Route Creation: Tap the X icon.

5. To start navigation, tap the check icon in the status bar.

Keypad

1. Press the GO TO key.
2. Select Quick Route.
3. Use the Joystick to move the cursor to a position or waypoint. Press the Joystick to mark the first route point.

4. Repeat Step 3 to connect more than one route point.

Undo Last Route Point: Press the EXIT key once.

Cancel Route Creation: Press and hold the EXIT key.

5. To start navigation, press the ENTER key.

Marking Route Points with the Touch Screen

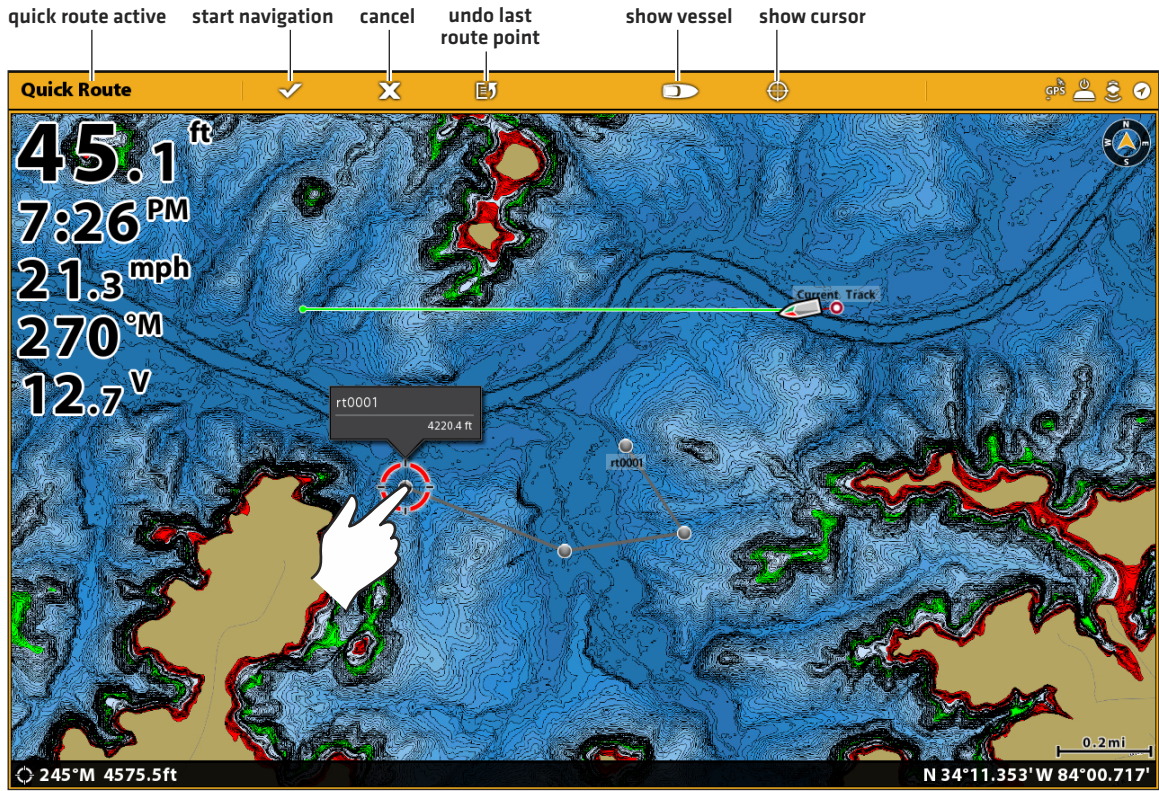

Tap to Mark
Route Points

Starting Quick Route Navigation with the Keypad

The screenshot displays a navigation interface with a map and various data points. The top bar is labeled "Quick Route" and contains several icons: a checkmark for "quick route active", a downward arrow for "start navigation", an 'X' for "cancel", an eraser for "undo last route point", a boat for "show vessel", and a crosshair for "show cursor". The map shows a route with points labeled "rt0001" and a "Current Track" line. A cursor is shown marking a route point. The map also displays depth contours, a scale bar (0.2 mi), and coordinates (245°M 4575.5ft, N 34°11.353' W 84°00.717').

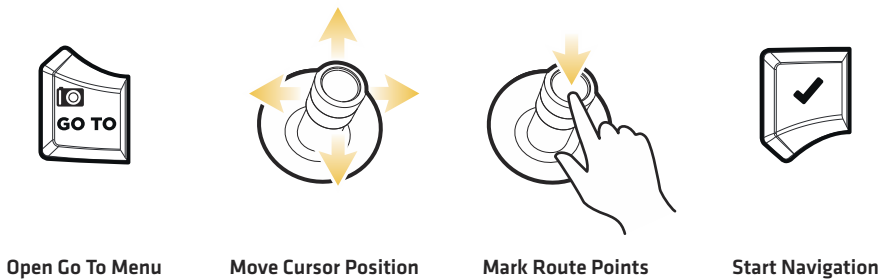

Change Route Order During Navigation

1. During navigation, tap Chart in the status bar. Select Go To.

OR

Press the GO TO key.

2. Select one of the following menu options:

Restart Course: Resets navigation to start from the current vessel position to the next point in the route.

Next Point: Skips to the next point in the route.

Reverse Route: Reverses the currently navigated route. Navigation will start from the vessel position and continue in the opposite order.

Cancel Quick Route Navigation

1. During navigation, tap Chart in the status bar. Select Go To.

OR

Press the GO TO key.

2. Select Cancel Navigation.
3. Select Save Route or Discard Route.

Start Navigation to a Saved Waypoint or Route

Use the cursor to select a saved waypoint or route point on the Chart View, and you can start navigation to it. If you select a route point, you can also choose a navigation order for the selected route.

Start Navigation

Touch Screen

1. Tap a waypoint icon or route point.
2. Tap Chart in the status bar.
3. Select Go To.
4. Select Go To: Route or Go To: Point.

Cancel Navigation: Tap Chart in the status bar. Select Go To > Cancel Navigation.

Keypad

1. Use the Joystick to move the cursor to a waypoint or route point.
2. Press the GO TO key.
3. Select Go To: Route or Go To: Point.

Cancel Navigation: Press the GO TO key. Select Cancel Navigation.

Program a Position and Start Navigation

Use the instructions in this section to enter a latitude/longitude position and start navigation to it.

Start Navigation to a Latitude/Longitude Position

1. Tap Chart in the status bar. Select Go To.

OR

Press the GO TO key.

2. Select Lat/Long.
3. Use the on-screen keyboard to enter a position.
4. Select Go To.

Cancel Navigation: Press the GO TO key. Select Cancel Navigation.

Create a Saved Route

The instructions in this section allow you to create a route in the Chart View and save it for navigation later. The steps are similar to creating a Quick Route, but you will use the Mark menu to start.

Save Location: The route is saved to the Nav Data tool.

Navigation: To start navigation on the route, see *Start Navigation to a Saved Waypoint or Route*.

Overlay: To display saved routes on the Chart View, press the MENU key once.
Select Chart Options > Overlays > Nav Data > Routes [Saved].

Create a Saved Route

Touch Screen

1. Tap Chart in the status bar.
2. Select Mark.
3. Select Route.
4. Tap the screen in the positions where you want to mark a route point.
Undo Last Route Point: Tap the Back icon.
Cancel Route Creation: Tap the X icon.
5. To save the route, tap the check icon in the status bar.

Keypad

1. Press the MARK key.
2. Select Route.
3. Use the Joystick to move the cursor to a position or waypoint. Press the Joystick to mark the first route point.
4. Repeat Step 3 to connect more than one route point.
Undo Last Route Point: Press the EXIT key once.
Cancel Route Creation: Press and hold the EXIT key.
5. To save the route, press the ENTER key.

Creating a Saved Route with the Keypad

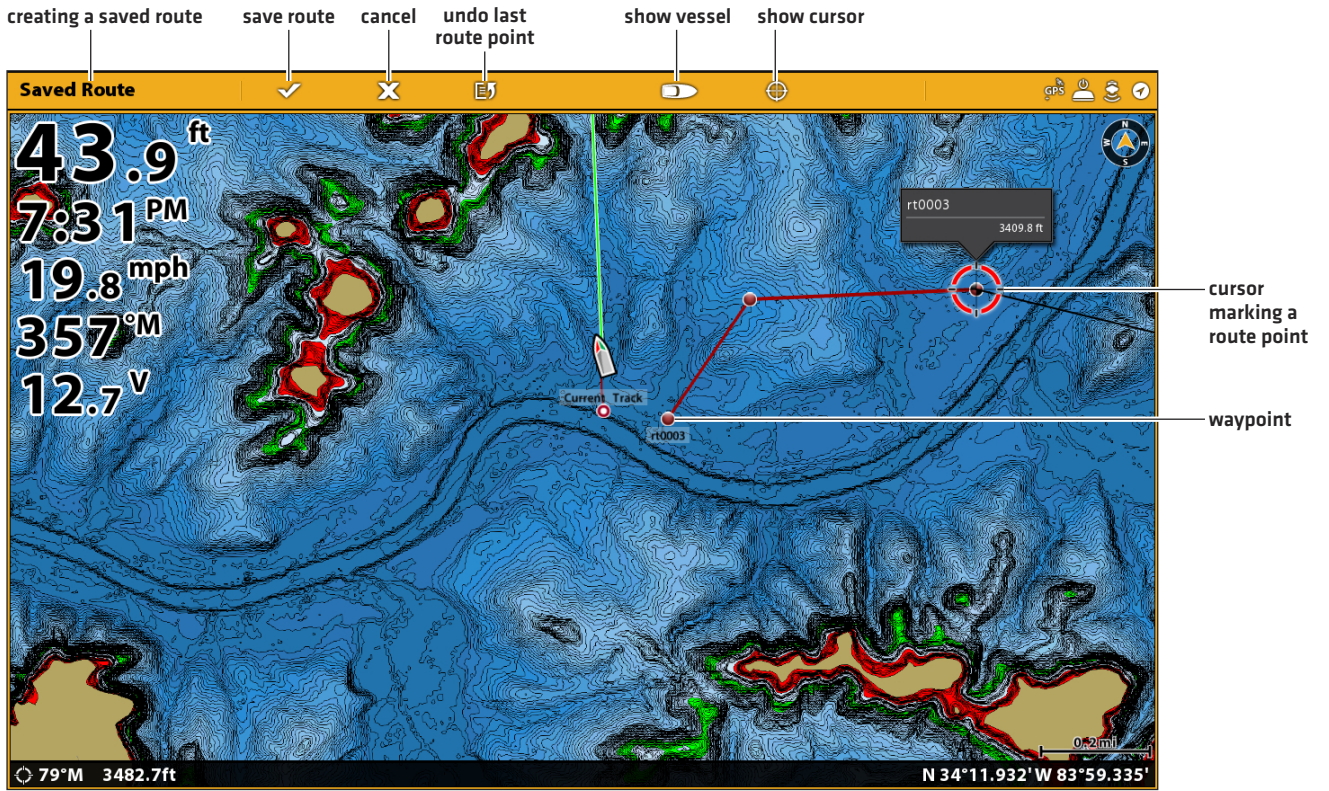

Open Mark Menu

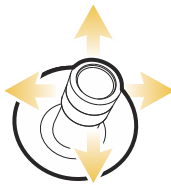

Move Cursor Position

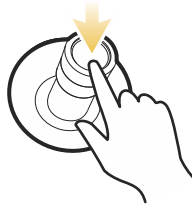

Mark Route Point



Save

Edit a Route in the Chart View

1. Tap the route to select it. Tap the Route Name.

OR

Use the Joystick to move the cursor to a route on the chart. Press the ENTER key.

2. Use the Route Info menu to edit the route name, color, and more [see *Manage your Navigation Data* for more information].

3. **Close:** Press the EXIT key.

Add or Delete Points in a Route

1. Tap the route to select it. Tap the Route Name.

OR

Use the Joystick to move the cursor to a route on the chart. Press the ENTER key.

2. Select Add Point, Extend Route, or Delete Point.

Delete a Route in the Chart View

1. Tap the route to select it. Tap the Route Name.

OR

Use the Joystick to move the cursor to a route on the chart. Press the ENTER key.

2. Select Delete Route.

Editing a Route on the Chart View

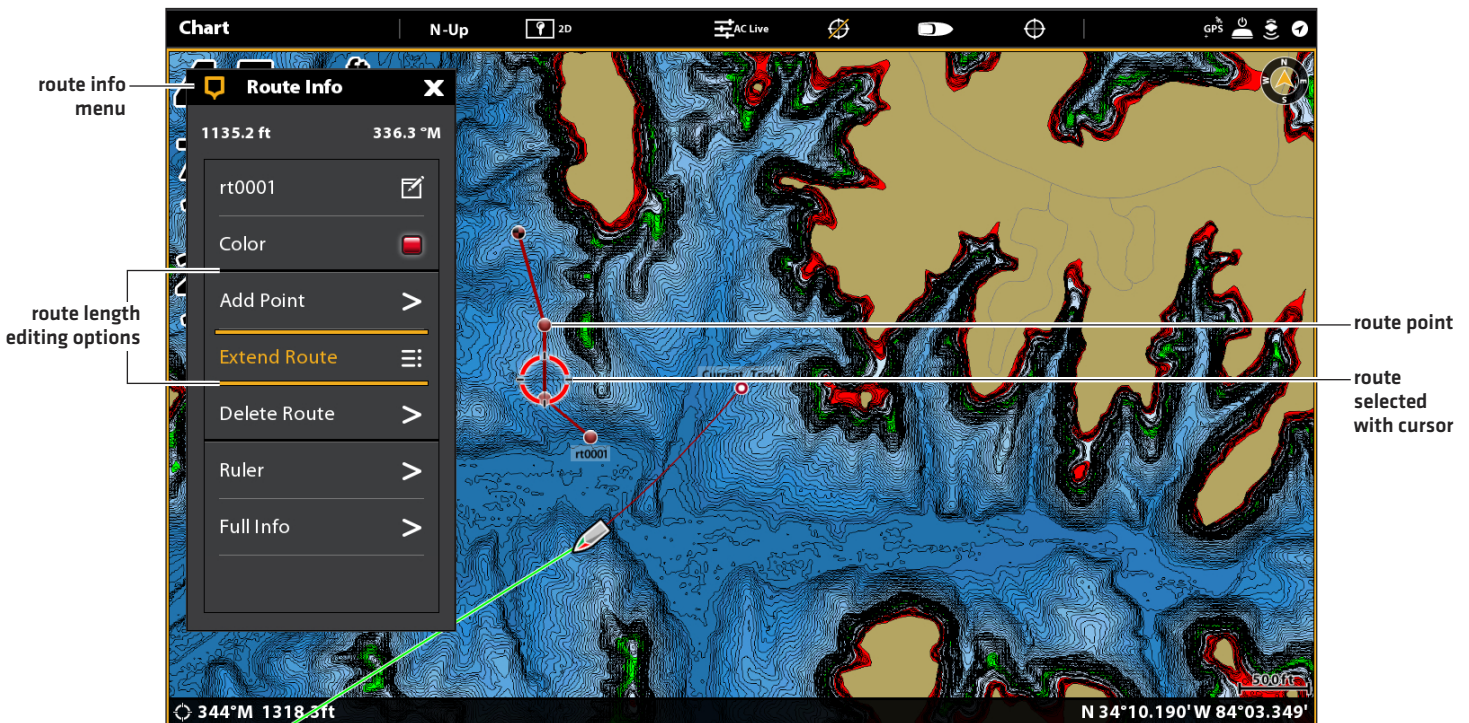

SEARCH

There are many ways to search the area for ports, services, tide stations, current stations, and other points of interest. You can also search the nearest waypoints, routes, and tracks. In many cases, you can also use the Go To menu to start navigation to your selection. The search options and the search area distance are determined by the selected map source.



NOTE: For more information about the ENTER key and the Info menu, see *Navigation Menu Overview*.

Search by Vessel Position

If Navionics is selected as the map source, you can run a search based on the vessel position.

1. Tap Chart in the status bar. Select Info.

OR

Press the ENTER key.

2. Select an item from the displayed list. Tap the item, or press the ENTER key, to see more information if it is available.
3. To start navigation to your selection, press the GO TO key.

Search by Cursor Position

If Navionics is selected as the map source, you can run a search based on the cursor position.

1. Press and hold a position on the Chart View.

OR

Use the Joystick to move the cursor to a position on the Chart View. Press the ENTER key.

2. Select Info.
3. Select an item from the displayed list. Tap the item, or press the ENTER key, to see more information if it is available.
4. To start navigation to your selection, press the GO TO key.

Search for a Lake

If Humminbird is selected as the map source, you can search for lakes in the area.

1. Tap Chart in the status bar. Select Info.

OR

Press the ENTER key.

2. **To search by area**, select Lake List.

To search by name, select Lake Name. Use the on-screen keyboard to enter a name.

3. Select an item from the displayed list. Tap the item, or press the ENTER key, to see more information if it is available.

Find the Nearest Navigation Data

Use the Find Nearest menu to search for the closest waypoints, routes, and tracks.

1. Tap Chart in the status bar. Select Info.

OR

Press the ENTER key.

2. Select Find Nearest.
3. Select Waypoints, Routes, or Tracks.
4. Select an item from the displayed list. Tap the item, or press the ENTER key, to see more information if it is available.
5. To start navigation to your selection, press the GO TO key.

TRACKS



A track is a collection of track points that contains the vessel's detailed position history at set intervals. The Current Track shows the position history since the control head was powered on. Record Track must be turned on to enable this feature [see **Record a Track**]. You can clear the Current Track or save it at any time. To change the track point interval, edit saved tracks, and create track settings, see **Manage your Navigation Data**. You can save 50 tracks [each with 20,000 track points] to the control head.



Start Point



End Point

Set up Tracks

Your control head is set to record tracks and display them on the view. Use the instructions in this section if you've changed the control head default settings.

Record a Track

When Record Track is turned on, the control head will save the current track. If Record Track is turned off, the track will not be recorded or saved.

1. Press the HOME key.
2. Select Nav Data tool.
3. Under Options, select Tracks.
4. Select Record Track. Tap the on/off button, or press the ENTER key, to turn it on.

Auto-Save

When Auto-Save is turned on, the control head will save the current track each time the control head is powered off, and a new track will be started when the control head is powered on again.

When Auto-Save is turned off, the current track will continue until you save it. See **Tracks: Save the Current Track**.

1. Press the HOME key.
2. Select Nav Data tool.
3. Under Options, select Tracks.
4. Select Auto Save. Tap the on/off button, or press the ENTER key, to turn it on.

Display Tracks on the Chart View

You can display saved tracks or active tracks on the Chart View.

1. With a Chart View displayed on-screen, tap Chart in the status bar.

OR

Press the MENU key once.

2. Select Chart Options.
3. Select Overlays > Nav Data.
4. Add a check mark to Tracks [Active] or Tracks [Saved] to make them visible on the Chart View.



NOTE: To set an individual track to visible or hidden, see **Manage your Navigation Data: Edit a Saved Track**.

Save the Current Track

Use the following instructions to save the current track and start a new track.

1. Tap a track start point or end point. Tap the Track Name.

OR

Use the Joystick to move the cursor to a track start point or end point. Press the ENTER key.

2. Select Save Track.



NOTE: You can also start a new track from the Nav Data tool. See **Manage your Navigation Data: Manage Tracks**.

Clear the Current Track

Use the following instructions to clear the current track and start a new track at the current vessel position.

1. Tap a track start point or end point. Tap the Track Name.

OR

Use the Joystick to move the cursor to a track start point or end point. Press the ENTER key.

2. Select Clear Track.

Chart View with a Track Displayed

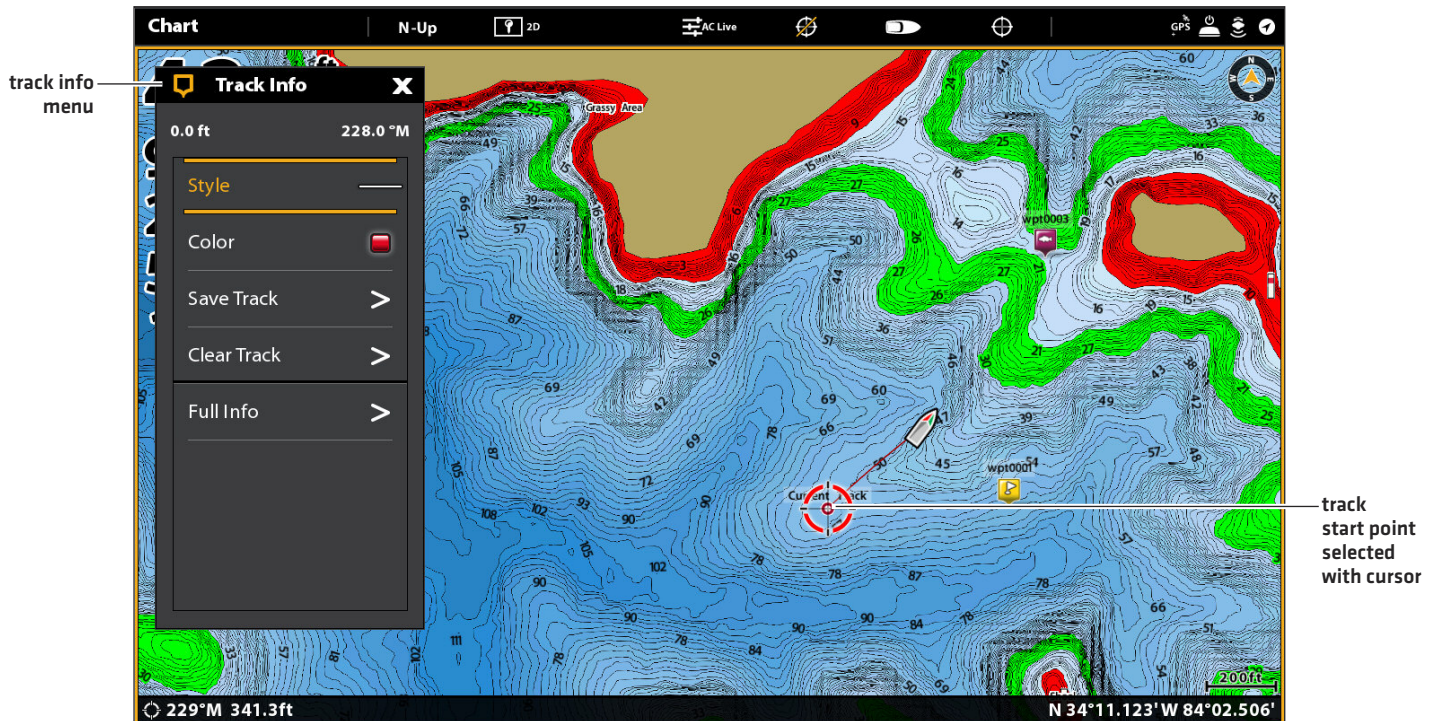

Edit a Track in the Chart View

1. Tap a track start point or end point. Tap the Track Name.

OR

Use the Joystick to move the cursor to a track start point or end point. Press the ENTER key.

2. Edit the track name, style, color, and more from the Track Info menu.

3. **Close:** Press the EXIT key.



NOTE: To change the default appearance for new tracks, or to change the Track Point Interval, see **Manage your Navigation Data: Manage Tracks**.

Delete a Saved Track

When you delete a saved track, it is permanently deleted from the control head.

1. Tap a track start point or end point. Tap the Track Name.

OR

Use the Joystick to move the cursor to a track start point or end point. Press the ENTER key.

2. Select Delete Track.

MANAGE YOUR NAVIGATION DATA

Use the Nav Data tool to manage your saved waypoints, routes, tracks, and groups. You can edit your saved navigation data and start navigation from this tool.

Open the Nav Data Tool

1. Press the HOME key.
2. Select the Nav Data tool.

Sort Lists

1. Select a saved waypoint, route, or track.
2. Press the EXIT key to select the sort bar. Tap a column name, or move the Joystick and press it on a column name. The first tap/Joystick press will sort the column low to high or A to Z. The second tap/Joystick press will sort it high to low or Z to A.

Nav Data Tool

The screenshot displays the Nav Data Tool interface. On the left, a sidebar menu lists 'Lists', 'Waypoints' (4), 'Routes' (2), 'Tracks' (1), 'Options', 'Waypoints', 'Routes', 'Tracks', 'Groups', and 'Delete All'. The main area shows a table of waypoints with columns for Name, Group, Distance, and Date. The selected waypoint 'wpt0004' is highlighted. Below the table, a preview window shows the selected waypoint's details: Position (N 34°11.783', W 84°3.580'), Bearing (277.9 °M), Depth (0.0 ft), Cursor Depth (0.0 ft), Radius (-), Temperature (-), and Altitude (-). A map view is also visible, showing the location of the waypoint on a waterway with various markers like 'Trees', 'Water', 'Danger Pole', 'Boulders', 'Rocks', and 'Boat House'.

Name	Group	Distance	Date
wpt0001	My Data	4582 ft	10/30/2015 7:24:24 PM
wpt0002	My Data	4835 ft	10/30/2015 7:26:02 PM
wpt0003	My Data	1.1 mi	10/30/2015 7:26:48 PM
wpt0004	My Data	1.4 mi	10/30/2015 7:27:00 PM

selected waypoint and preview window summary

Manage Waypoints

Edit a Waypoint

1. Under Lists, select Waypoints.
2. Press and hold a waypoint. Select Info.

OR

Use the Joystick to select a waypoint. Press the ENTER key.

3. Edit the waypoint using the options in the Waypoint Info menu. To see the complete list of options to edit the waypoint, select Full Info.

Editing Options for Saved Waypoints or Default Settings	
Waypoint Name	Select the waypoint name and use the on-screen keyboard to change it.
Icon	Select an icon category (water, fishing, navigation, POI [point of interest], etc.) and select an icon to represent the selected waypoint on the Chart Views.
Color	Select a color to represent the waypoint on the Chart Views.
Depth Marker	If Depth Marker is turned on, the waypoint will be displayed as a depth marker on the Chart View. The depth is based on the depth at the vessel position. See Waypoints: Create a Depth Marker . If the waypoint was marked at the cursor position, the depth will not be saved. Select Edit Depth to enter a depth manually.
Position	Use the on-screen keyboard to edit the latitude/longitude position of the waypoint.
Radius	Turn on Radius and set the radius around the waypoint. The Radius is used for Waypoint Avoidance [see Navigation Alarms Overview].
Avoidance	Add a check mark to the Avoidance box to display the Waypoint Avoidance Radius.
Visibility	To display the waypoint on the view, select On. To hide the waypoint on the view, select Off. You can also choose to display the icon or the icon and the waypoint name.
My Data [Group Name]	The menu name will vary with the default group name. Select the group name to change where the selected waypoint is saved. See Groups for more information.
Edit Depth	Use the on-screen keyboard to enter a depth for the waypoint if it was not marked at the vessel position. See Depth Marker for more information.
Edit Notes [select Full Info]	Use the on-screen keyboard to add notes about the waypoint.

Change the Mark Mode for New Waypoints

When you mark a waypoint, the control head assigns an alphanumeric name that can be edited from the Nav Data tool. Use these instructions to change how the control head marks a waypoint, allowing you to mark and edit waypoints as you go, or mark waypoints and edit them with your favorite settings.

1. Under Options, select Waypoints.
2. Select Mark Mode.

Mark Mode Options	
Default	When you mark a waypoint, the waypoint name is alphanumeric and starts with wpt. The waypoint can be edited at a later time. You can also change the default settings (icon, color, etc.) for new waypoints. See <i>Change Default Settings for New Waypoints</i> .
Mark + Edit	When you mark a waypoint, the Waypoint Info menu opens so you can edit the waypoint when you mark it.
Mark Favorites	When you mark a waypoint, the Favorites menu opens so you can assign a favorite icon and color to the waypoint on the go. To create favorite settings, see <i>Create Favorite Settings</i> .

Change Default Settings for New Waypoints

Each time you mark a new waypoint, the control head will use the default settings to save the waypoint.

1. Under Options, select Waypoints.
2. Select Default Settings. You can change the default settings for the icon, color, and more. See the table ***Editing Options for Saved Waypoints or Default Settings*** in this section for details.

Create Favorite Settings

If you've selected Mark Favorites as the Mark Mode for waypoints, use the instructions in this section to preset your favorite icon, color, depth marker, default group, and whether the waypoint is visible or hidden. When you mark a waypoint, you will be given the menu options from your favorite settings to edit the waypoint. Also, see [Waypoints: Mark Favorite Waypoints \(on the go\)](#) for more information.

1. Under Options, select Waypoints.
2. Select Favorite Settings. Tap the item or use the Joystick to make your selections.

Selecting 5 Favorite Colors



Editing Options for Favorite Waypoint Settings	
Icon	Select 5 icons to be your favorite icons.
Color	Select 5 colors to be your favorite colors.
Depth Marker	If Depth Marker is turned on, the waypoint will be displayed as a depth marker on the Chart View. The depth is based on the depth at the vessel position. See Waypoints: Create a Depth Marker . If the waypoint was marked at the cursor position, the depth will not be saved. Select Edit Depth to enter a depth manually.
Group	The menu name will vary with the default group name. Select the group name to change where the selected waypoint is saved. See Groups for more information.
Visibility	To display the waypoint on the Chart Views, select On. To hide the waypoint on the Chart Views, select Off.

Delete a Waypoint

1. Under Lists, select Waypoints.
2. Tap a waypoint or use the Joystick to select it.
3. Press the ENTER key.
4. Select Full Info.
5. Select Delete.

Navigate to a Selected Waypoint

1. Under Lists, select Waypoints.
2. Tap a waypoint or use the Joystick to select it.
3. Press the GO TO key.
4. Press the ENTER key, or tap Go To on-screen.

Manage Routes

Edit a Route

1. Under Lists, select Routes.
2. Press and hold a route. Select Info.

OR

Use the Joystick to select a route. Press the ENTER key.

3. Edit the route using the options in the Route Info menu.

To see the complete list of options to edit the route, select Full Info.

Editing Options for New Routes or a Saved Route	
Route Name	Select the route name and use the on-screen keyboard to change it.
Color	Select a color to represent the route on the Chart Views.
Visibility	To display the route on the view, select On. To hide the route on the view, select Off.
My Data [Group Name]	The menu name will vary with the default group name. Select the group name to change where the route is saved. See Groups for more information.
Edit Notes [select Full Info]	Use the on-screen keyboard to add notes about the route.

Change Default Settings for New Routes

1. Under Options, select Routes.
2. Select Default Settings.

Selected Route with Route Points

The screenshot displays a navigation application interface. On the left, a sidebar titled 'Nav Data' contains a 'Lists' section with 'Waypoints 4', 'Routes 2', and 'Tracks 1'. The 'Routes' list is highlighted, with a label 'routes selected' pointing to it. The main area shows a table of routes:

Name	Group	Distance	Date
rt0002	My Data	1.9 mi	10/30/2015 7:24:41 PM
rt0001	My Data	2.0 mi	10/30/2015 7:11:28 PM

The route 'rt0002' is highlighted and labeled 'selected route'. Below the table, a detailed view for 'rt0002' is shown, including a map with route points, a 'Notes' field, and summary statistics: Position (N 34°11.673', W 84°3.389'), Bearing (291.9 °M), Route Distance (3124 ft), and Route Points (5). A label 'selected route and preview window summary' points to this detailed view.

Delete a Route Point

Touch Screen

1. Under Lists, select Routes.
2. Tap a route to open it and display its route points.
3. Press and hold a route point.
4. Select Info.
5. Select Full Info.
6. Select Delete Point.

Keypad

1. Under Lists, select Routes.
2. Use the Joystick to select a route. Press the Joystick to open the route and display its route points.
3. Select a route point.
4. Press the ENTER key.
5. Select Full Info.
6. Select Delete Point.

Delete a Route

This menu option is not available while the selected route is being navigated.

1. Under Lists, select Routes.
2. Press and hold a route. Select Delete.

OR

1. Use the Joystick to select a route. Press the ENTER key.
2. Select Full Info.
3. Select Delete Route.

Navigate a Selected Route

1. Under Lists, select Routes.
2. Tap a route or use the Joystick to select it.
3. Press the GO TO key.
4. Press the ENTER key, or tap Go To on-screen.

Manage Tracks

Track Options for the Current Track

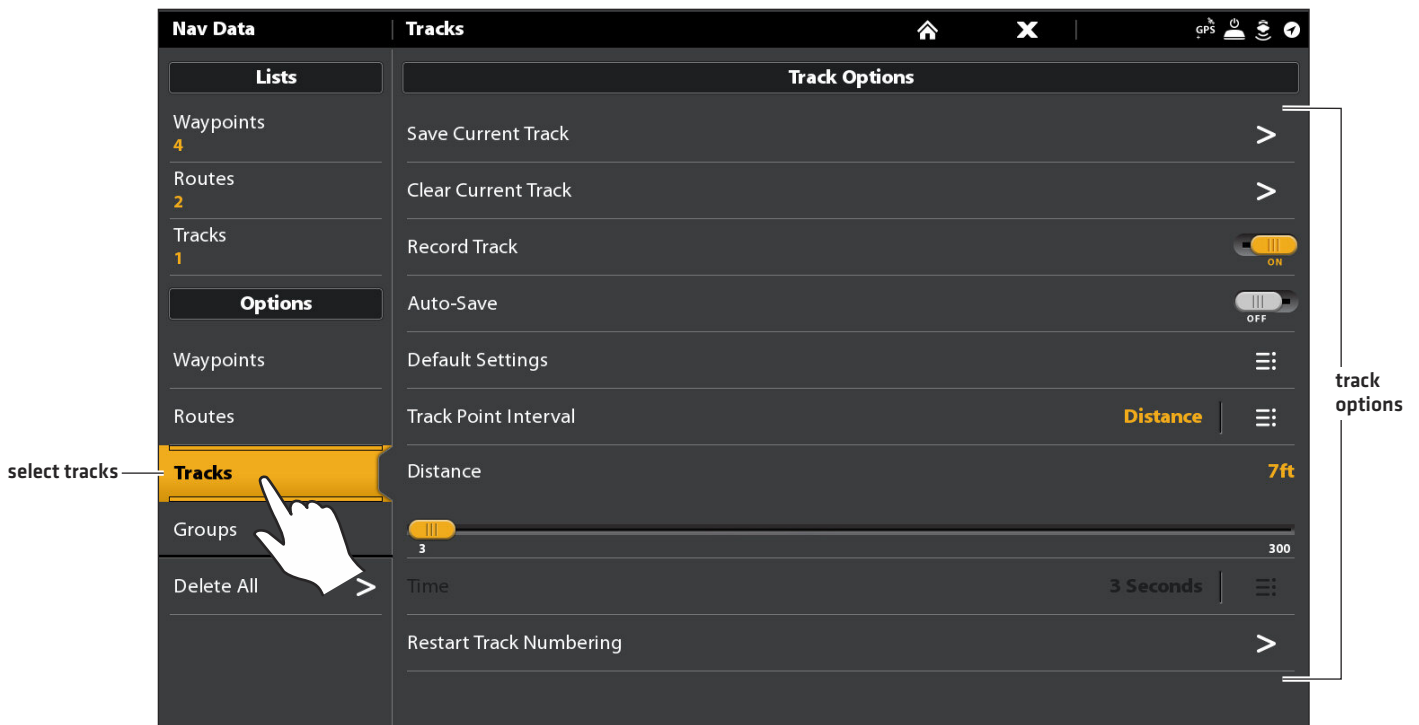

Start a New Track

The Record Track menu must be turned on to enable this feature.

1. Under Options, select Tracks.
2. Select New Track.

Record a Track

When Record Track is turned on, the control head will save the current track. If you power off the control head and then power on the control head at a different position, there might be gaps in the track.

If Record Track is turned off, the track will not be displayed on the Chart View, and the track will not be recorded or saved.

1. Under Options, select Tracks.
2. Select Record Track. Tap the on/off button, or press the ENTER key, to turn it on.

Auto-Save

When Auto-Save is turned on, the control head will save the current track each time the control head is powered off, and a new track will be started when the control head is powered on again.

When Auto-Save is turned off, the current track will continue until you save it [see **Tracks: Save the Current Track**].

1. Under Options, select Tracks.
2. Select Record Track. Tap the on/off button, or press the ENTER key, to turn it on. The control head will start recording the current track at the moment the menu is turned on.

Change Default Settings for New Tracks

1. Under Options, select Tracks.
2. Select Default Settings.

Changing the Default Settings for New Tracks	
Style	Select a line style.
Color	Select a color.
Group	Select the group name to change where tracks will be saved. You can also open a new group from this menu. See Groups for more information.

Change the Track Point Interval

1. Under Options, select Tracks.
2. Select Track Point Interval.
3. Select Distance or Time.
4. Select the Back icon on the status bar, or select the Tracks tab under Options to return to the Track Options menu.
5. If you selected Distance in step 3, adjust the Distance slider to adjust the distance between track points.

If you selected Time in step 3, select Time and open the menu. Select the amount of time between track points.

Edit a Saved Track

1. Under Lists, select Tracks.
2. Press and hold a track. Select Info.

OR

Use the Joystick to select a track. Press the ENTER key.

3. Edit the saved track using the options in the Track Info menu.

To see the complete list of options to edit the track, select Full Info.

Editing Options for a Saved Track	
Track Name	Select the track name and use the on-screen keyboard to change it.
Style	Select a line style.
Color	Select a color.
Visibility	To display the track on the Chart Views, select On. To hide the track on the Chart Views, select Off.
My Data [Group Name]	The menu name will vary with the default group name. Select the group name to change where the selected track is saved. See Groups for more information.
Edit Notes [select Full Info]	Use the on-screen keyboard to add notes about the selected track.

Delete a Track

1. Under Lists, select Tracks.
2. Press and hold a track. Select Delete.

OR

1. Use the Joystick to select a track. Press the ENTER key.
2. Select Full Info.
3. Select Delete Track.

Manage Groups

Use Groups to organize your navigation data (waypoints, routes, and tracks) in one set. Some anglers prefer to group their navigation data by trip, fish-type, body of water, or time of day.

Default Group: Your navigation data is saved to My Data, the default group for your control head. You can create new groups and save new navigation data to them. You can also move saved navigation data to a different group.

Create a New Group

1. Under Options, select Groups.
2. Select New Group.
3. Use the on-screen keyboard to name the new group.
4. Select Save.

Set the Default Group

Your navigation data is saved to My Data as the default group. The instructions in this section allow you to save your new navigation data to a different group, so as a waypoint, route, or track is saved, it will be saved to the group you've set up. You can assign waypoints, routes, and tracks to different groups, or you can assign them to the same group.

1. Under Options, select Waypoints, Routes, or Tracks.
2. Select Default Settings.
3. Select Group.
4. Select a group from the list.
To create a new group, Select New Group.
5. Repeat these instructions for each type of navigation data.

Move Navigation Data to a Group

1. Under Lists, select Waypoints, Routes, or Tracks.
2. Tap a saved item or use the Joystick to select it.
3. Press the ENTER key.
4. Select My Data (or the current group name).
5. Select a group from the list.
To create a new group, select New Group.

Delete All Navigation Data

The Delete All menu allows you to select a navigation data category and delete all items in that category. For example, if you select Delete All > Waypoints, all saved waypoints will be deleted.

To delete individual waypoints, or other individual navigation items, see the previous sections of *Manage your Navigation Data*.



WARNING! Use this menu with caution!

1. Under Options, select Delete All.
2. Select a category. **Follow the on-screen prompts to confirm the deletion.**

Import/Export Navigation Data

The SOLIX allows you to export your waypoints, routes, and tracks, so you can view the data on your personal computer. You can also import your navigation data.



WARNING! Humminbird is not responsible for the loss of data files [waypoints, routes, tracks, groups, snapshots, recordings, etc.] that may occur due to direct or indirect damage to the unit's hardware or software. It is important to back up your control head's data files periodically. Data files should also be saved to your PC before restoring the unit's defaults or updating the software. See your Humminbird online account at humminbird.com for details.

Import Navigation Data

Requirements: Humminbird navigation data saved as a GPX file.

1. Install the SD card [with navigation data] into the front control head port.
2. Press the HOME key.
3. Select the Files tool.
4. Under Import, select Nav Data.
5. Select a .GPX file. The navigation data will be imported to the control head.

Export Navigation Data

1. Install a formatted SD card into the front control head port.
2. Press the HOME key.
3. Select the Files tool.
4. Under Export, select Nav Data.
5. **Select a Save Location:** Select the port where the SD card is installed.

All saved navigation data will be exported to the selected location.

AUTOCHART LIVE OVERVIEW

AutoChart LIVE uses data from an installed GPS receiver and 2D transducer (down beam, digital CHIRP or single-frequency DualBeam PLUS) to create detailed depth maps of your favorite waters.

Map Source: Humminbird LakeMaster or Navionics

Storage: AutoChart LIVE saves 8 hours of mapping data on your control head. After 8 hours of data has been collected, you can erase the data and continue mapping, or you can purchase a ZeroLine Map Card for unlimited mapping.

ZeroLine Map Card: To purchase a ZeroLine Map Card and download the accessory guide, visit our Web site at humminbird.com.

More Information: Visit our Web site for informational videos.

PLAN YOUR MAP

Before getting started, consider the areas where you want to create a map. Review the following tips to help you plan your map:

General Tips

- Start with your favorite fishing hot spots. It is not recommended to record survey data of an entire lake, as it will require a lot of time to map and might include areas you don't want.
- Take a different route to and from each fishing spot every trip. You may discover new and interesting areas to map.
- Start a new track or recording when you start for the day. Record new data every trip to create new maps or improve existing maps.
- Navigate the boat at a consistent speed when recording data.
- See the illustration below for instruction on how to navigate your boat while recording survey data.

Mapping a Specific Area or Object in Detail

- Navigate the boat across the area rather than alongside.
- Turn the boat where the area and/or object is out of range of the transducer beam[s].
- Try to reduce the measurement time, so as to reduce the error due to possible GPS variations.

Mapping an Entire Lake

- Follow a plan.
- Follow the maximum gradient of the sea floor (up or down).
- Keep a steady speed. Trolling speeds to low speeds are recommended.
- Turn the boat where the bottom is flat if possible.

Navigating the Boat to Record Survey Data

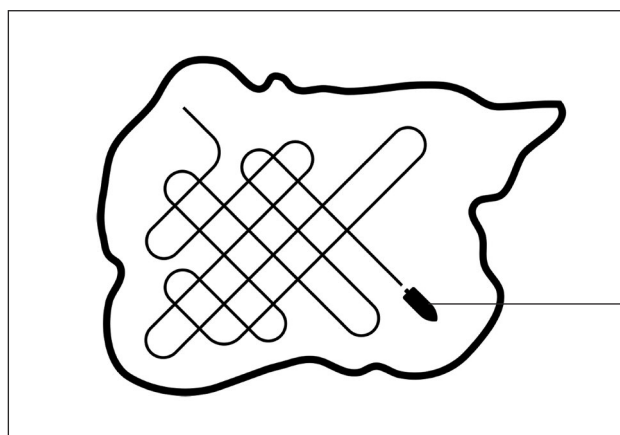

Navigate your boat in a zig-zag pattern, first in one direction and then in the other.

1. PREPARE THE CONTROL HEAD FOR MAPPING

When you start your mapping for the day, it is important to note if the water level is higher or lower than usual. It is also important to use your 2D transducer beams exclusively.

1 | Set the Map Source

AutoChart LIVE can be used when Humminbird LakeMaster or Navionics is set as the map source. When you install a map card, the map source is changed automatically to match the SD card map source. If your control head has two cards installed, you can choose which map source you want to use. You can also change the map source using the Settings tool.

1. Press the HOME key.
2. Select Settings.
3. Select Chart.
4. Select Humminbird or Navionics.

2 | Confirm the 2D Transducer and Turn off Additional Transducers

To record your custom map, you must have a reliable and accurate digital depth from a pinging 2D transducer. You can use your Humminbird CHIRP transducer with 2D (down beam) capabilities, DualBeam PLUS transducer (83/200 kHz or 50/200 kHz), or the Side Imaging transducer with 2D (down beam) capabilities.

When you are recording your map, you should have only one 2D transducer pinging on your boat. If you have other 2D transducers pinging on remote control heads, you should turn them off. Down Imaging and Side Imaging beams can operate at the same time. You do not need to turn them off.

1. Press the HOME key.
2. Select Settings.
3. Select CHIRP Sonar.
4. Select Sonar Source.
5. Select the 2D Sonar tab.
6. Confirm that 2D Pinging is turned on. Tap the **2D Pinging** on/off button, or press the ENTER key, to turn it **on**.

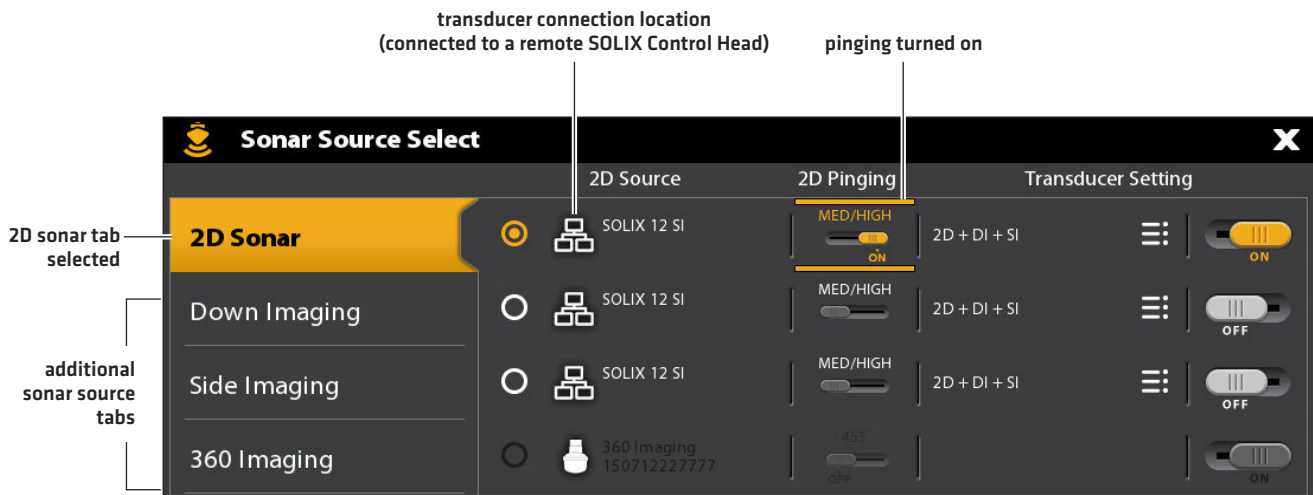

NOTE: For more information about the Sonar Source Select dialog box, see **Set up your Humminbird Network: Select Sonar Sources.**

7. Press and hold the EXIT key to close the menu system.
8. If there are additional control heads on your boat with a 2D transducer, confirm that they are not pinging while you are mapping. There should be only one 2D transducer pinging on your boat during the recording process.

3 | Confirm Digital Depth and GPS Fix

1. Press the HOME key.
2. Select a Chart View from the Views tool or the Favorites bar.
3. **Confirm Digital Depth:** Confirm the depth digital readout is displayed.
It may take a moment for depth to be displayed.
4. **Confirm GPS Fix:** Review the status bar and confirm the GPS icon is white. Confirm the speed digital readout is displayed. See *Getting Started: Check Sensor Reception and Connections* for more information.

digital depth missing



digital depth detected

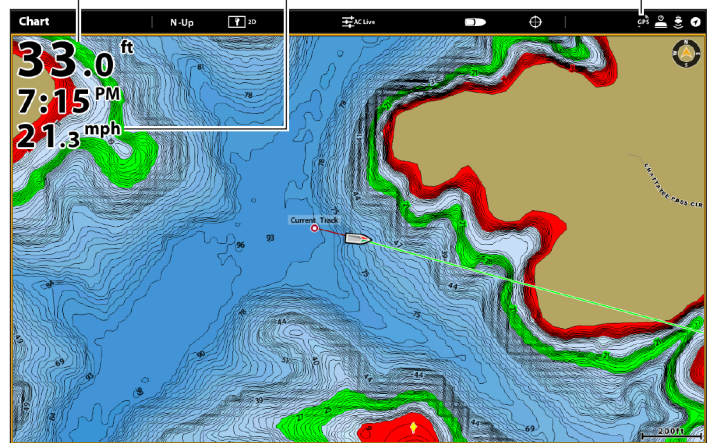

speed

GPS sensor check

4 | Adjust the Water Level Offset

When you start your mapping for the day, it is important to note if the water level is higher or lower than usual. For example, if you know the lake is down 3 feet, set the Water Level Offset to -3.

1. With a Chart View displayed on-screen, tap Chart in the status bar, or press the MENU key once.
2. Select Water Level Offset.
Tap the on/off button, or press the ENTER key, to turn it on.
3. Press and hold the slider, or press and hold the ENTER key, to adjust the setting.

If the water level is higher than normal, set a positive amount.

If the water level is lower than normal, set a negative amount.

If the water level has not changed [normal], turn off Water Level Offset.

5 | Display the Current Track [optional]

It is helpful to display the current track so you can see where the boat has already traveled while you're recording the map.

1. With a Chart View displayed on-screen, tap Chart in the status bar, or press the MENU key once.
2. Select Chart Options.
3. Select Overlays > Nav Data.
4. Tap the Nav Data on/off button, or press the ENTER key, to turn it on.
5. Add a check mark to Tracks [Active].
6. Press and hold the EXIT key until the menu system is closed.

To change the track color, see *Manage your Navigation Data: Manage Tracks*.

6 | Start a Sonar Recording for AutoChart PC [optional]

If you are planning to use AutoChart PC, start a sonar recording before you start recording your custom map. Sonar Recording can be started from the Recordings tool or from the X-Press Menu in a Sonar View. The instructions for the Recordings tool are shown here.

1. Press the HOME key.
2. Select the Recordings tool.
3. Select Record Sonar.
4. Select Recording Sources. Tap 2D Sonar, or press the ENTER key, to add a check mark to the box.
5. Press the EXIT key.
6. Select Start Recording.



NOTE: For more information, see *Sonar Recording*. Also, visit our Web site at humminbird.com to purchase AutoChart PC and download the manual.

2. RECORD YOUR CUSTOM MAP

While recording your custom map, Chart View will display the depth contour data in real time. Bottom hardness and vegetation will be recording at the same time, however, the data is not displayed in real time on the Chart View.

1. **Preparation:** Before you start mapping for the day, confirm that the control head is set up as shown in the section *Prepare the Control Head for Mapping*.
2. With a Chart View displayed on-screen, tap Chart in the status bar, or press the MENU key once.
3. Select AutoChart LIVE.
4. Select Record.
5. Tap the on/off button, or press the ENTER key, to turn it on.

Display: Select AutoChart LIVE. Tap the check box, or press the ENTER key, to add a check mark to it.

Zoom In: Press the + ZOOM key to see the depth data on the Chart View.

Navigate your boat in a zig-zag pattern, first in one direction and then in the other. Maintain a consistent low speed to trolling speed while you map. See *Plan your Map* for details.

Starting an AutoChart LIVE Recording

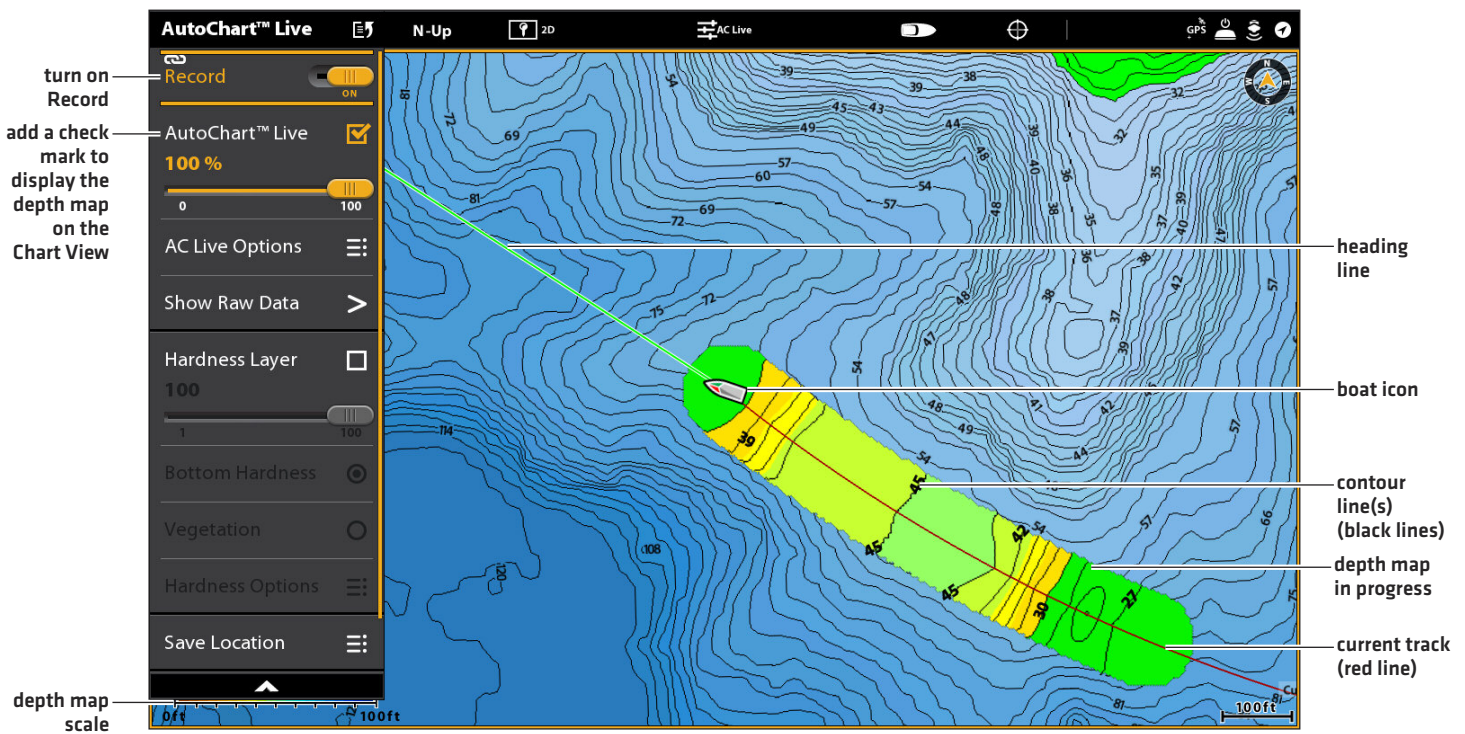

Collecting Data for your AutoChart LIVE Map

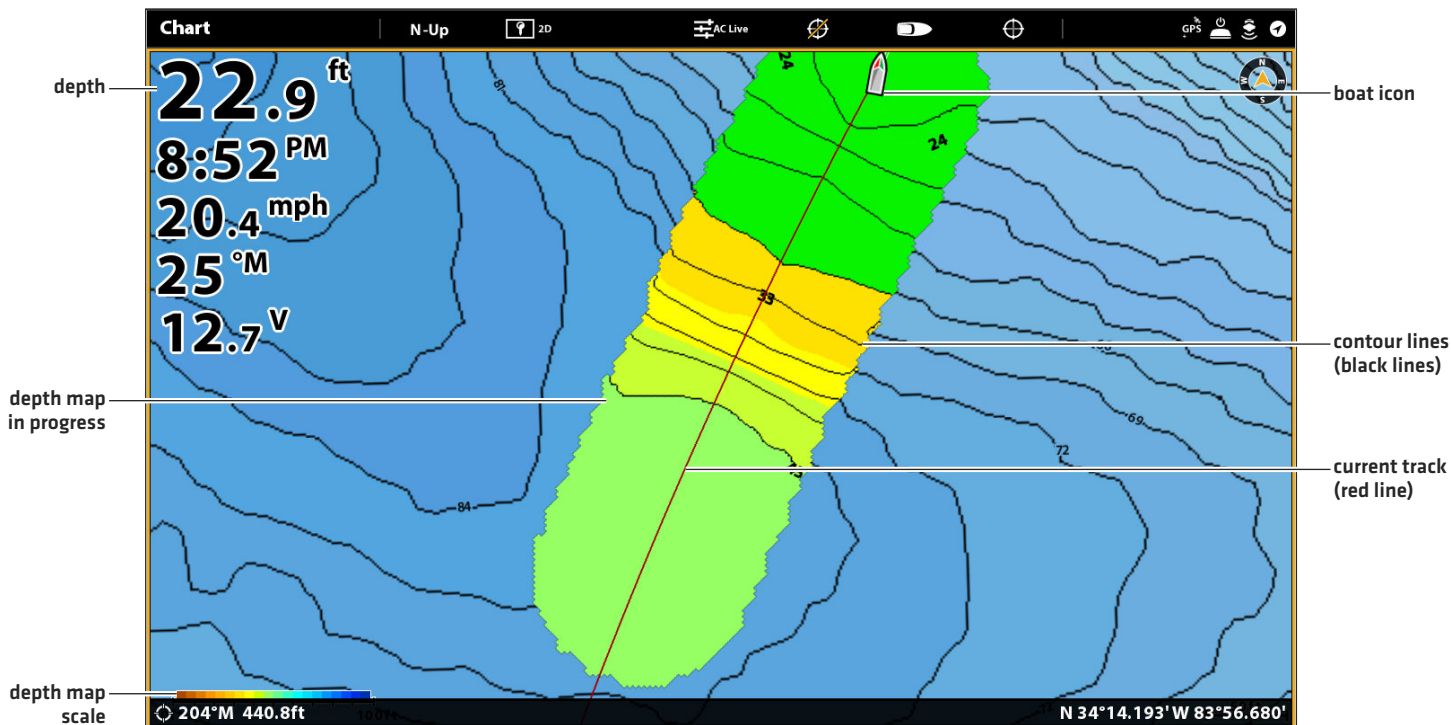

3. STOP RECORDING

Use the instructions in this section to stop recording. Your map is automatically saved to the control head [internal] or to the ZeroLine Map Card if it is installed.

1. With a Chart View displayed on-screen, tap Chart in the status bar, or press the MENU key once.
2. Select AutoChart LIVE.
3. Select Record. Tap the on/off button, or press the ENTER key, to turn it off.

If you do not have a ZeroLine Map Card installed, and the control head storage [8 hours] is reached, the control head will provide a dialog box to Confirm or Clear Data. To save your map and turn off recording, select Confirm. To erase your map and start over, select Clear Data.

CORRECT DATA

If you see an irregularity in the data [such as lost depth], it can be corrected. Recording must be turned off while you correct the data.

1. With a Chart View displayed on-screen, tap Chart in the status bar, or press the MENU key once.
2. Select AutoChart LIVE.
3. **Turn Off Recording:** Select Record. Tap the on/off button, or press the ENTER key, to turn it off.
4. Select Show Raw Data.
5. Press the +ZOOM key to see individual data points.
6. Tap the data point, or use the Joystick to select the data point.
7. From the AutoChart LIVE menu, select Delete Data.

Optional: Record the area again. See *Record your Custom Map*.

Selecting a Data Point

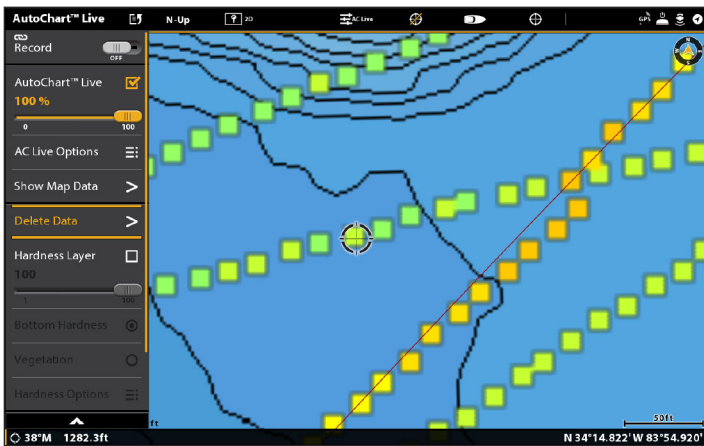

The Data Point is Removed

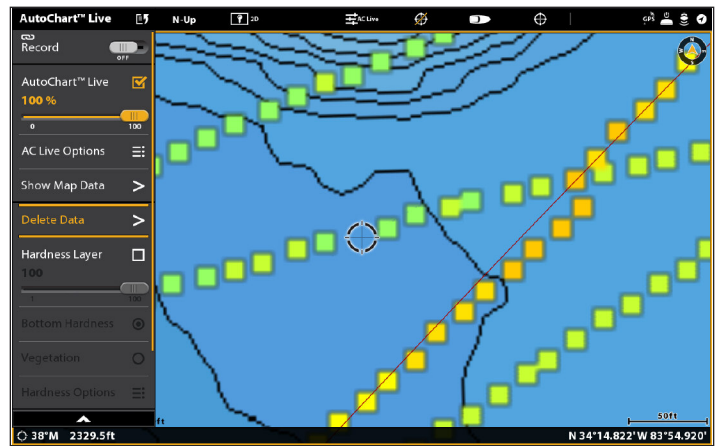

DISPLAY THE AUTOCHART LIVE MAP

You can make changes to the AutoChart Live map during recording or after you've saved your map. You can also view bottom hardness or vegetation data, and you can customize how the data is displayed.

Display/Hide your Custom Map

The custom map can be displayed or hidden while you are recording or after the map is saved. You can also adjust the transparency.

Display the Map

1. With a Chart View displayed on-screen, tap Chart in the status bar, or press the MENU key once.
2. Select AutoChart LIVE.
3. Select AutoChart LIVE. Tap the check box, or press the ENTER key, to add a check mark to it.

Adjust the Transparency

1. Press and hold the AutoChart LIVE slider, or turn the Rotary dial, to adjust the transparency.

Adjusting the Overlay Transparency

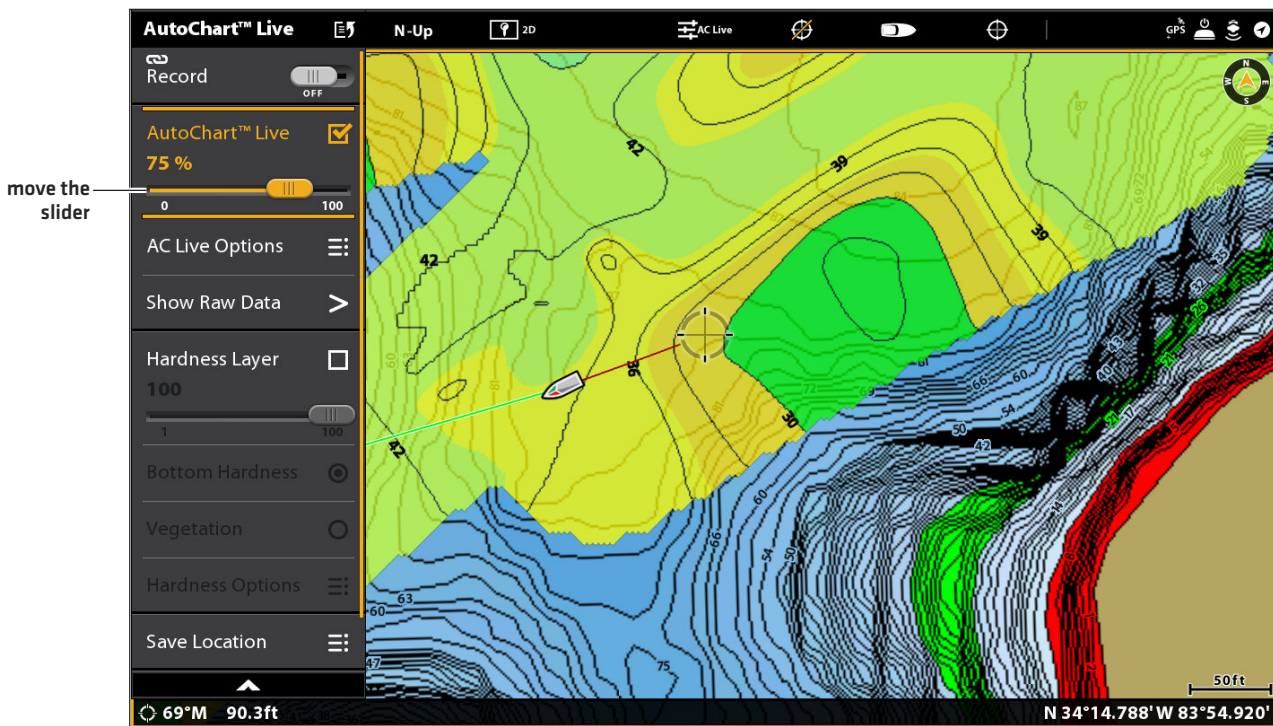

Hide the Map

1. With a Chart View displayed on-screen, tap Chart in the status bar, or press the MENU key once.
2. Select AutoChart LIVE.
3. Select AutoChart LIVE. Tap the check box, or press the ENTER key, to remove the check mark.

Display the AC Live Color Bar

The AC Live Color bar allows you to display the palette icon for AutoChart Live or Bottom Type. You can use this icon to see the selected palette and, from left to right, the AutoChart Live depth range [low to high], Bottom Hardness range [soft to hard], or Vegetation range [soft to hard].

Show/Hide the AC Live Color Bar

1. With a Chart View displayed on-screen, tap Chart in the status bar, or press the MENU key once.
2. Select Chart Options.
3. Select Overlays > AC Live Color Bar.
4. Select Color Bar. Tap, or press the ENTER key, to turn it on.
5. Select a display bar.

Display AutoChart Live and Bottom Layer in Chart/Chart Combo View

You can also use the Chart/Chart Combo View to display AutoChart Live and Bottom Layer data at the same time. Use the X-Press Menu to make adjustments to each pane.

Display AutoChart Live and Bottom Layer Data in the Chart/Chart Combo View

1. Press the HOME key.
2. Open the Views tool.
3. Select a Chart/Chart Combo View.
4. With the Chart/Chart Combo View displayed on-screen, select a pane.
5. Tap Chart in the status bar, or press the MENU key once.
6. Select AutoChart Live.
7. Select Vegetation Layer or Hardness Layer. Tap the check box, or press the ENTER key, to add a check mark to it.
8. **Adjust the Transparency:** Press and hold the slider, or turn the Rotary dial, to adjust the transparency.
9. **Close:** Press the EXIT key until the menu is closed.
10. **Repeat:** Repeat steps 4 through 6.
11. Select AutoChart Live. Tap the check box, or press the ENTER key, to add a check mark to it.
12. **Adjust the Transparency:** Press and hold the slider, or turn the Rotary dial, to adjust the transparency.

Displaying AutoChart Live and Bottom Layer in Chart/Chart Combo View

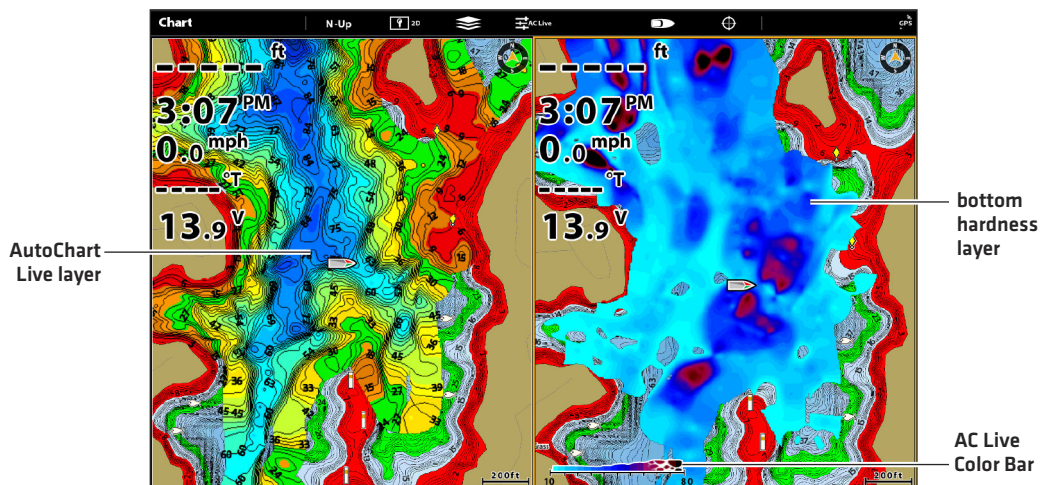

ADJUST THE MAP DISPLAY SETTINGS

Use the AutoChart Live Options menu to adjust the depth range, contour interval, and map position. You can also change the color palette and shading.

Some of the menu options in this section may be displayed in other parts of the menu system so that you can access them quickly. No matter where you make the change, the control head will update the setting across the system.

Open the AutoChart Live Options Menu

You will use the AutoChart Live Options menu for all display settings.

1. With a Chart View displayed on-screen, tap Chart in the status bar, or press the MENU key once.
2. Select AutoChart LIVE.
3. Select AC Live Options.

Adjust the Depth Range

You can adjust the range of data shown on the chart by changing the minimum range and maximum range on the display. The range you select affects how the depth colors are displayed. For best results, set a narrow depth range threshold. For example, set the Min Range to 10 and the Max Range to 30. For related color or shading options, see *Add Settings with Chart Options*.

1. From the AC Live Options menu, select Min Range.
2. Press and hold the slider, or press and hold the ENTER key, to adjust the setting.
3. Select Max Range.
4. Press and hold the slider, or press and hold the ENTER key, to adjust the setting.

Adjusting the Display Depth Range

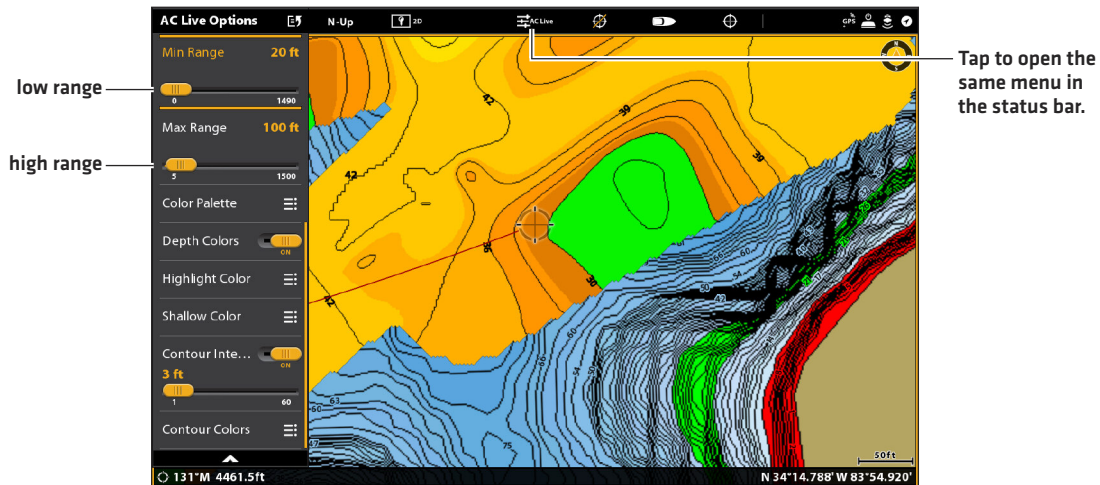

QUICK TIP! You can also select this menu on the status bar. See the illustration above.

Change the Display Colors

Use the following instructions to change the color palette used to display the AutoChart Live map.

Changing the AutoChart Live Color Palette

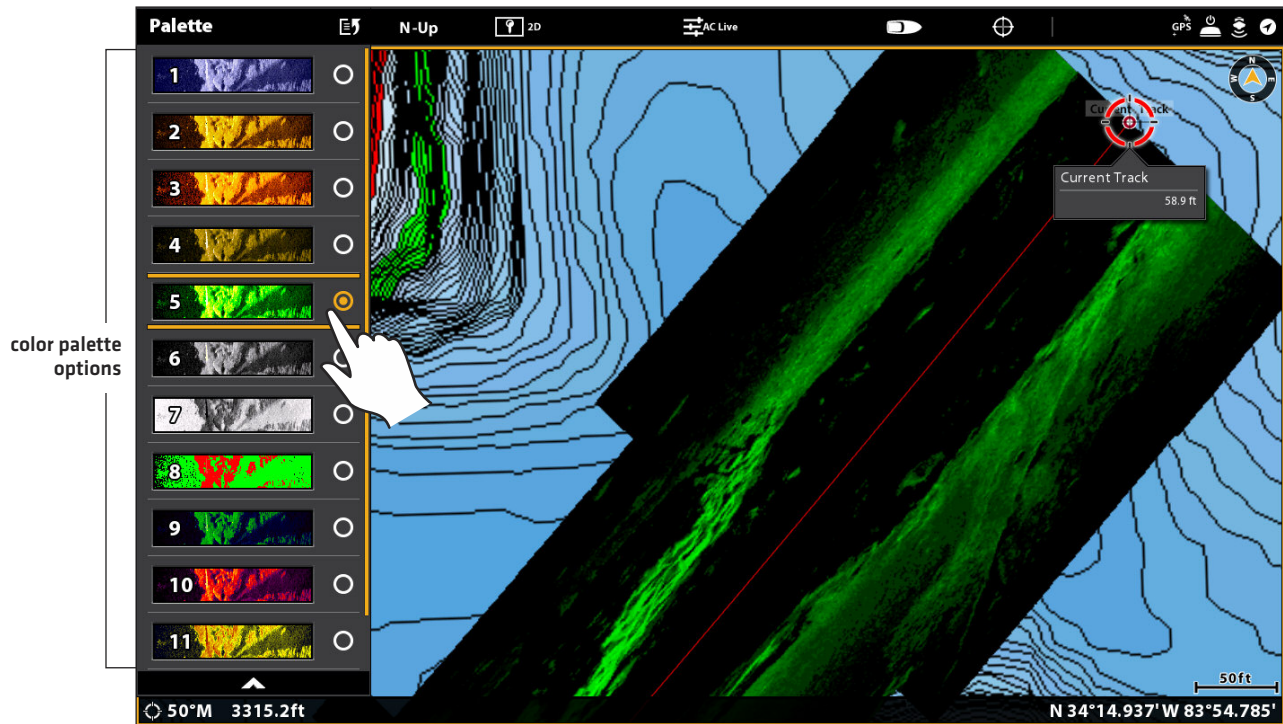

Change the Color Palette

The Color Palette menu changes the colors used to display the AutoChart Live map. The color range is shown in the AC Live Color bar and is affected by the Min Range and Max Range settings. See **Adjust the Depth Range** for more information.

1. From the AutoChart Live Options menu, select Color Palette.
2. Select a palette.

Show/Hide Depth Colors

Use the following instructions to show or hide the depth colors. If you hide the depth colors, the contours will be shown on the display.

1. From the AutoChart Live Options menu, select Depth Colors.
2. Tap the on/off button, or press the ENTER key, to turn it On [visible] or Off [hidden].

Change the Highlight Color

If you've set the Depth Highlight and Depth Highlight Range in the Humminbird Settings menu [Chart X-Press Menu > Humminbird Settings], and it is not easy to see with the AutoChart Live color palette you've selected, you can change the Highlight Color. See **Customize the Chart View** for more information.

1. From the AutoChart Live Options menu, select Highlight Color.
2. Select a color.

Change the Shallow Color

If you've set the Shallow Water Highlight in the Humminbird Settings menu (Chart X-Press Menu > Humminbird Settings), and it is not easy to see with the AutoChart Live color palette you've selected, you can change the Shallow Color. See **Customize the Chart View** for more information.

1. From the AutoChart Live Options menu, select Shallow Color.
2. Select a color.

Display or Adjust the Contour Interval

You can display or hide the contour lines on the map, and you can adjust the slider to set the distance between each contour line. Contour Interval is also affected by the Water Level Offset setting.

Display the Contour Lines and Adjust the Contour Interval

1. From the AutoChart Live Options menu, select Contour Interval.
2. Tap the on/off button, or press the ENTER key, to turn it on.
3. Press and hold the slider, or press and hold the ENTER key, to adjust the setting.

Change the Contour Lines Color

1. From the AutoChart Live Options menu, select Contour Colors.
2. Select a color.

Adjusting the Contour Interval

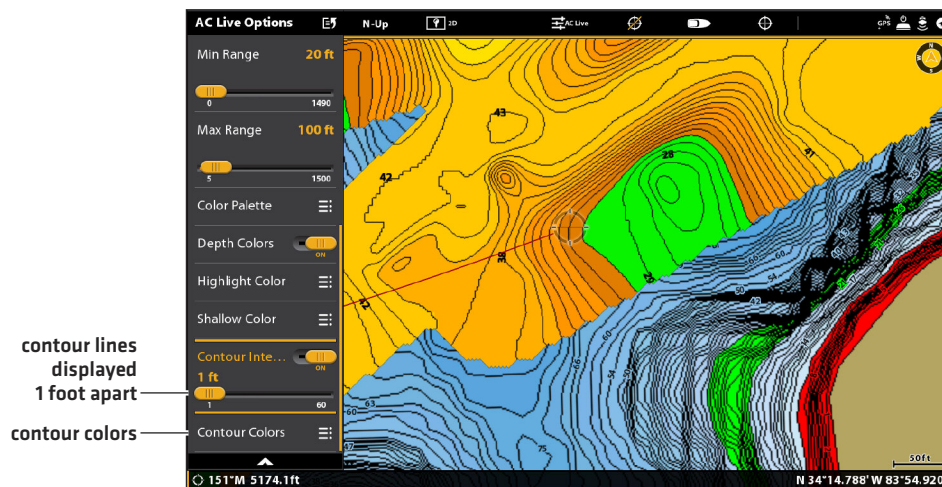

Display Raw or Map Data

Select Show Map Data to display contour lines and depth data. Select Show Raw Data to display individual data points.

1. From the AutoChart Live menu, select Show Raw Data or Show Map Data.
2. Press the ENTER key.

Change the Water Level Offset

When you start your mapping for the day, it is important to note if the water level is higher or lower than usual. See *Prepare the Control Head for Mapping* for more information.

1. From the AutoChart Live Options menu, select Water Level Offset.
2. Tap the on/off button, or press the ENTER key, to turn it on.
3. Press and hold the slider, or press and hold the ENTER key, to adjust the setting.

If the water level is higher than normal, set a positive amount.

If the water level is lower than normal, set a negative amount.

If the water level has not changed [normal], turn off Water Level Offset.

Add Humminbird Chart Settings

If Humminbird is set as the map source, you can add Depth Colors, Shallow Water, etc. to your AutoChart LIVE map. See *Customize the Chart View: Adjust the Depth Range and Colors* for more information.

Adding Shallow Water Settings to the Map (Map Source: Humminbird)

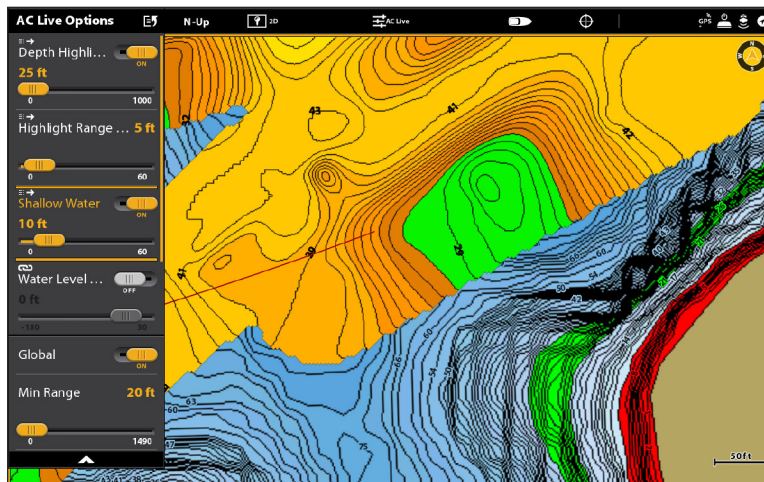

Add Navionics Settings with Chart Options

If Navionics is set as the map source, you can display Contours and Shading on your AutoChart LIVE map. See *Customize the Chart View: Select Map Data* for more information.

CUSTOMIZE THE BOTTOM HARDNESS DISPLAY SETTINGS

The bottom layer is displayed on top of the AutoChart Live map and can be displayed as bottom hardness or vegetation. Bottom Hardness shows strong sonar returns resulting from compacted sediment, rocks, fallen trees, etc.

Show/Hide Bottom Hardness

The bottom layer is displayed on top of the AutoChart Live map, and you can adjust the transparency to see different layers on the view. Both bottom hardness and bottom vegetation cannot be displayed at the same time in Chart View.

Show Bottom Hardness

1. From the AutoChart Live menu, select Hardness Layer or Vegetation Layer. Tap, or press the ENTER key, to add a check mark to the box.
2. Select Bottom Hardness.
3. **Adjust the Transparency:** Press and hold the slider, or press and hold the ENTER key, to adjust the setting.

Displaying the Bottom Hardness Layer (Map Source: Humminbird)

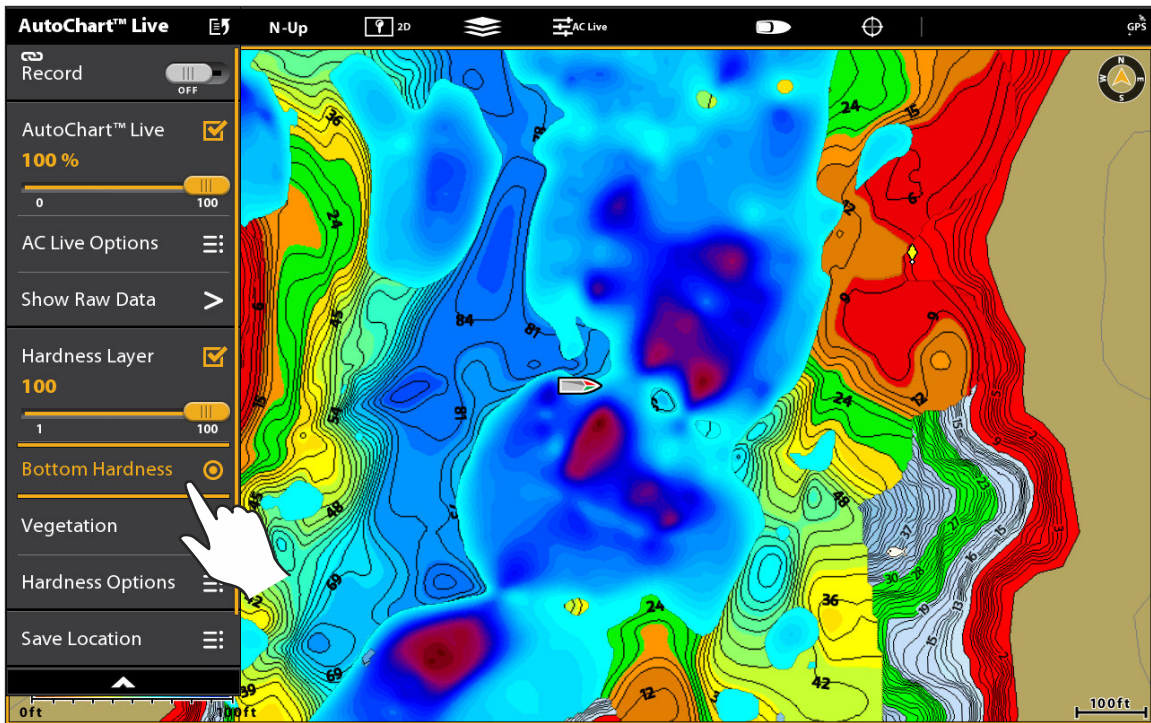

Hide Bottom Hardness

1. From the AutoChart Live menu, select Hardness Layer. Tap, or press the ENTER key, to remove the check mark from the box.

Adjust the Gain Offset

Use Gain Offset to tune the bottom hardness display. For example, if you're fishing a lake where most of the lake has a hard bottom, reduce the gain so only the hardest bottom is displayed.

1. From the AutoChart Live menu, select Hardness Options.
2. Select Gain Offset.
3. Press and hold the slider, or press and hold the ENTER key, to adjust the setting.

Adjust the Hardness Range

You can adjust the range of bottom hardness shown on the chart by changing the minimum range and maximum range on the display. The range you select affects how the bottom hardness colors are displayed. The range is displayed in the AC Live Color Bar with Bottom Hardness selected.

1. From the AutoChart Live menu, select Hardness Options.
2. Select Min Hardness. Press and hold the slider, or press and hold the ENTER key, to adjust the setting.
3. Select Max Hardness. Press and hold the slider, or press and hold the ENTER key, to adjust the setting.

Adjusting the Bottom Hardness Range (Map Source: Humminbird)

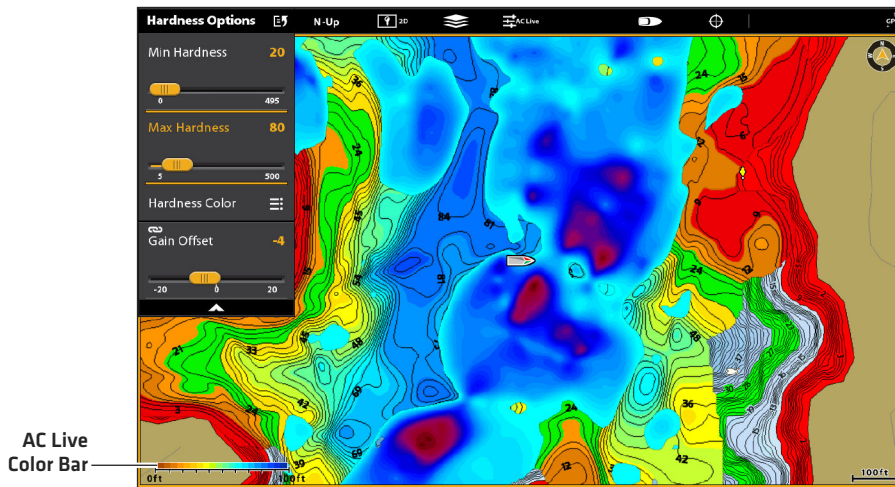

NOTE: Use the AC Live Color Bar icon see the selected palette and, from left to right, the AutoChart Live depth range [low to high], Bottom Hardness range [soft to hard], or Vegetation range [soft to hard].

Change the Bottom Hardness Colors

Use the following instructions to change the color palette used to display Bottom Hardness.

Change the Hardness Colors

The Hardness Color menu changes the colors used to display bottom hardness on the view. The color range is shown in the AC Live Color bar and is affected by the Min Hardness and Max Hardness settings. See **Adjust the Hardness Range** for more information.

1. From the AutoChart Live menu, select Hardness Options.
2. Select Hardness Color.
3. Select a palette.

Changing the Bottom Hardness Colors (Map Source: Humminbird)

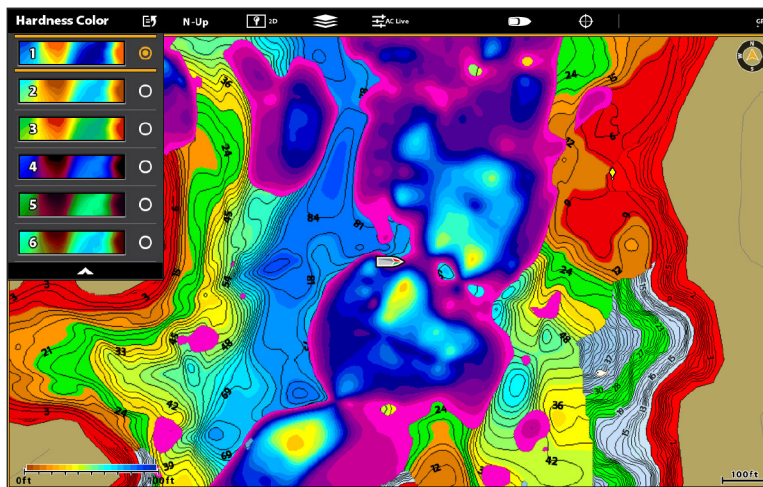

CUSTOMIZE THE VEGETATION DISPLAY SETTINGS

The Bottom Layer is displayed on top of the AutoChart Live map and can be displayed as bottom hardness or vegetation. Vegetation shows the sonar returns interpreted as vegetation on the Chart View. Both bottom hardness and bottom vegetation cannot be displayed at the same time in Chart View.

Show/Hide Vegetation

Show Vegetation

1. From the AutoChart Live menu, select Hardness Layer or Vegetation Layer. Tap, or press the ENTER key, to add a check mark to the box.
2. Select Vegetation.
3. **Adjust the Transparency:** Press and hold the slider, or press and hold the ENTER key, to adjust the setting.

Displaying the Vegetation Layer (Map Source: Humminbird)

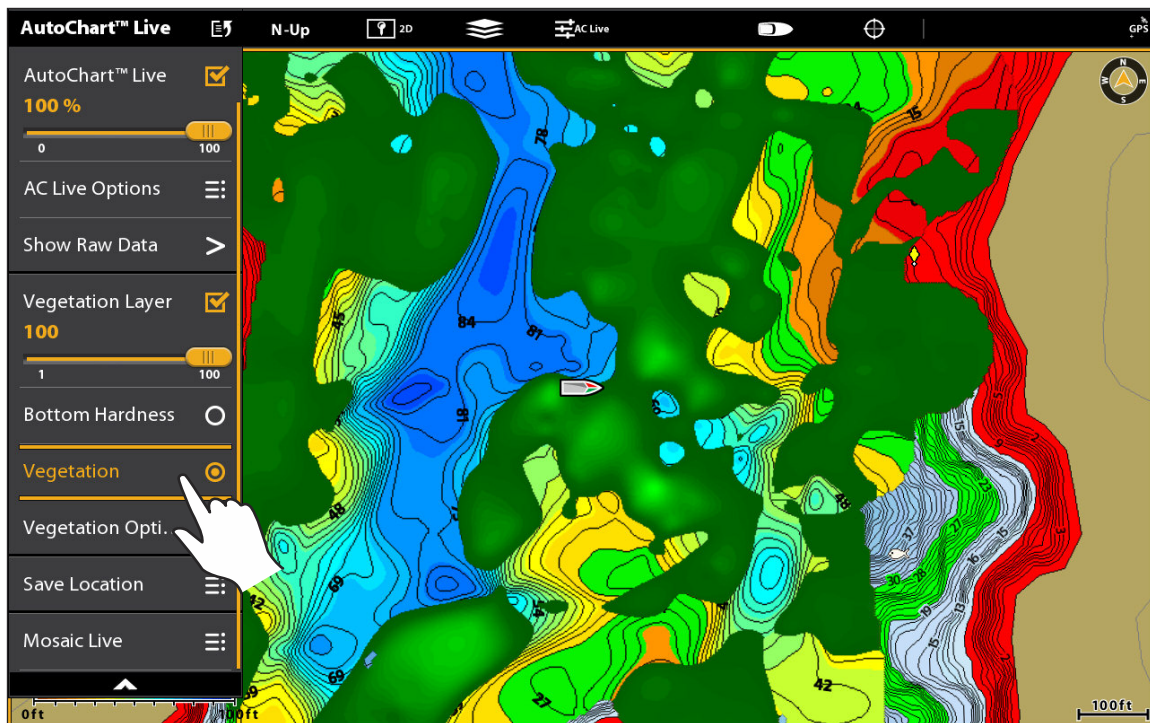

Hide Vegetation

1. From the AutoChart Live menu, select Vegetation Layer. Tap, or press the ENTER key, to remove the check mark from the box.

Adjust the Gain Offset

Use Gain Offset to tune the vegetation display. Vegetation will vary with the lake, season, or environment you are fishing, and you should adjust the Gain Offset as needed.

1. From the AutoChart Live menu, select Vegetation Options.
2. Select Gain Offset.
3. Press and hold the slider, or press and hold the ENTER key, to adjust the setting.

Adjust the Vegetation Range

You can adjust the range of vegetation shown on the chart by changing the minimum range and maximum range on the display. The range you select affects how the vegetation colors are displayed.

1. From the AutoChart Live menu, select Vegetation Options.
2. Select Min Vegetation. Press and hold the slider, or press and hold the ENTER key, to adjust the setting.
3. Select Max Vegetation. Press and hold the slider, or press and hold the ENTER key, to adjust the setting.

Adjusting the Vegetation Hardness Range (Map Source: Humminbird)

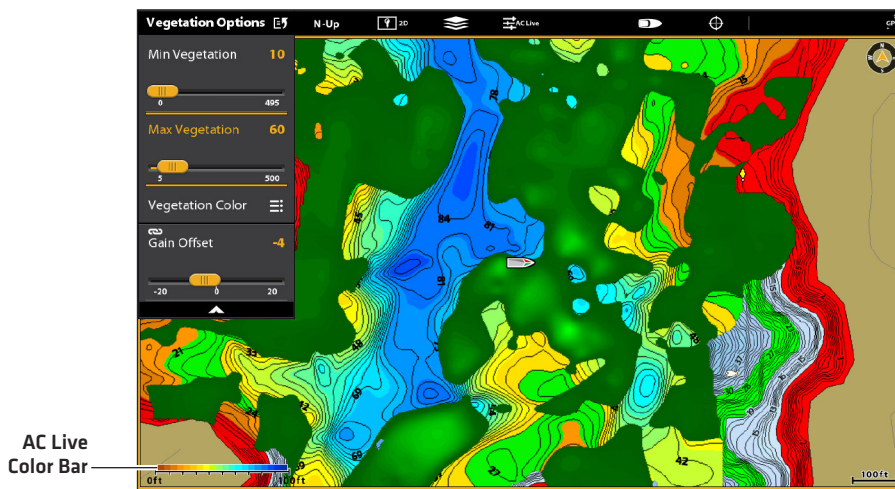



NOTE: Use the AC Live Color Bar icon see the selected palette and, from left to right, the AutoChart Live depth range [low to high], Bottom Hardness range [soft to hard], or Vegetation range [soft to hard].

Change the Vegetation Colors

The Vegetation Color menu changes the colors used to display vegetation on the view. The color range is shown in the AC Live Color bar and is affected by the Min Vegetation and Max Vegetation settings. See **Adjust the Vegetation Range** for more information.

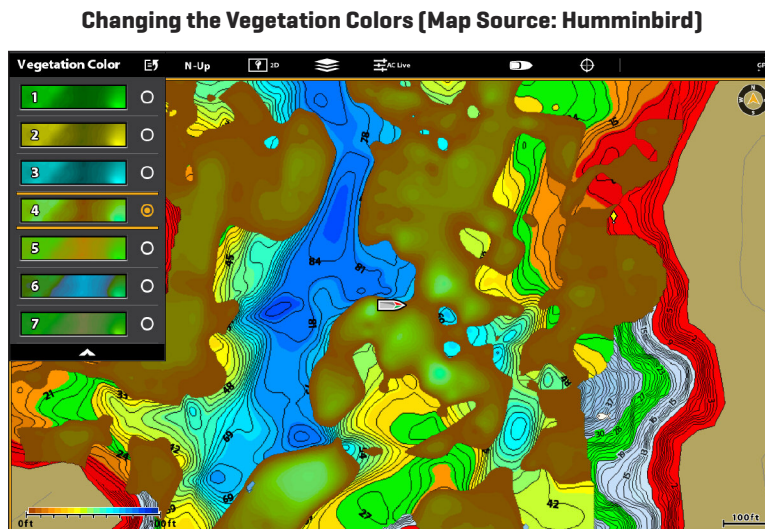
1. From the AutoChart Live menu, select Vegetation Options.
2. Select Vegetation Color.
3. Select a palette.



 **NOTE:** Use the AC Live Color Bar icon see the selected palette and, from left to right, the AutoChart Live depth range [low to high], Bottom Hardness range [soft to hard], or Vegetation range [soft to hard].

MOSAIC LIVE OVERVIEW

The Mosaic Live feature allows you to display Side Imaging data on the Chart View. A Mosaic can be displayed as an overlay while it is being recorded, and you can display saved Mosaics on the Chart View. Mosaic can also be used with a 360 Imaging transducer [separate purchase required].

Required Equipment: A Side Imaging transducer or a 360 Imaging transducer, and an SD Card to save recordings.

Map Source: Humminbird LakeMaster or Navionics

AutoChart PC: To display Mosaic Live data in AutoChart PC, use Sonar Recording. See the **Sonar Recording** section of this manual and the AutoChart PC Installation and Operations Guide for details [separate purchase required].

Accessories: To purchase a 360 Imaging transducer, AutoChart PC, or other related equipment, visit our Web site at humminbird.com.

FOR BEST PERFORMANCE

Many of the features that are available on the Side Imaging View or 360 Imaging View are available when a Mosaic is displayed on the Chart View.

If you are using a Side Imaging transducer or 360 Imaging transducer to display Mosaic Live data, it is important to consider the following tips for best performance:

Side Imaging Transducer

- **Vessel Speed:** 2 to 6 mph
- Straight line navigation
- Minimum turning time and wave turbulence
- To understand how Side Imaging works, review the **Side Imaging Overview** section of this manual.

360 Imaging Transducer

- **Vessel Speed:** 0 to 7 mph. The transducer pod should NOT be in the water during high speed travel.
- Straight line navigation
- Minimum turning time and wave turbulence
- To understand how 360 Imaging works, review the manual that is included with the transducer.

When recording the Mosaic, you should have only one Side Imaging sonar source pinging on your boat. To select a Side Imaging sonar source or confirm pinging, see **Set up your Humminbird Network: Select Sonar Sources**.

OPEN THE MOSAIC LIVE MENU

1. Press the HOME key.
2. Select a Chart View.
3. Tap Chart in the status bar, or press the MENU key once.
4. Select AutoChart Live.
5. Select Mosaic Live.

Record and Save a Mosaic

When you record a Mosaic, the control head displays the data as an overlay on the Chart View. If you are planning to use AutoChart PC, start a sonar recording before you start recording your Mosaic [see **Sonar Recording**].

The Mosaic must be saved when you are finished recording or before you power off the control head, or the data will be lost. See the instructions below.

1. Open the Mosaic Live Menu.
2. Select Record. Tap the on/off button, or press the ENTER key, to turn it on.
Speed: See **For Best Performance** in this section.
Display the Mosaic: Select Mosaic. Tap the check box, or press the ENTER key, to add a check mark to it.
3. **Save:** Open the Mosaic Live Menu. Select Save Mosaic.
4. **Select the Save Location:** Select Save Location. Select the location where an unlocked SD card is installed [SD Card 1 or SD Card 2].
5. Press the EXIT key.
6. Select Save.

⚠ WARNING! A Mosaic must be saved when you are finished recording or before you power off the control head, or the data will be lost. Save the recording before you turn off the Record menu.

7. **Stop Recording:** Select Record. Tap the on/off button, or press the ENTER key, to turn it off.

Recording a Mosaic in the Chart View

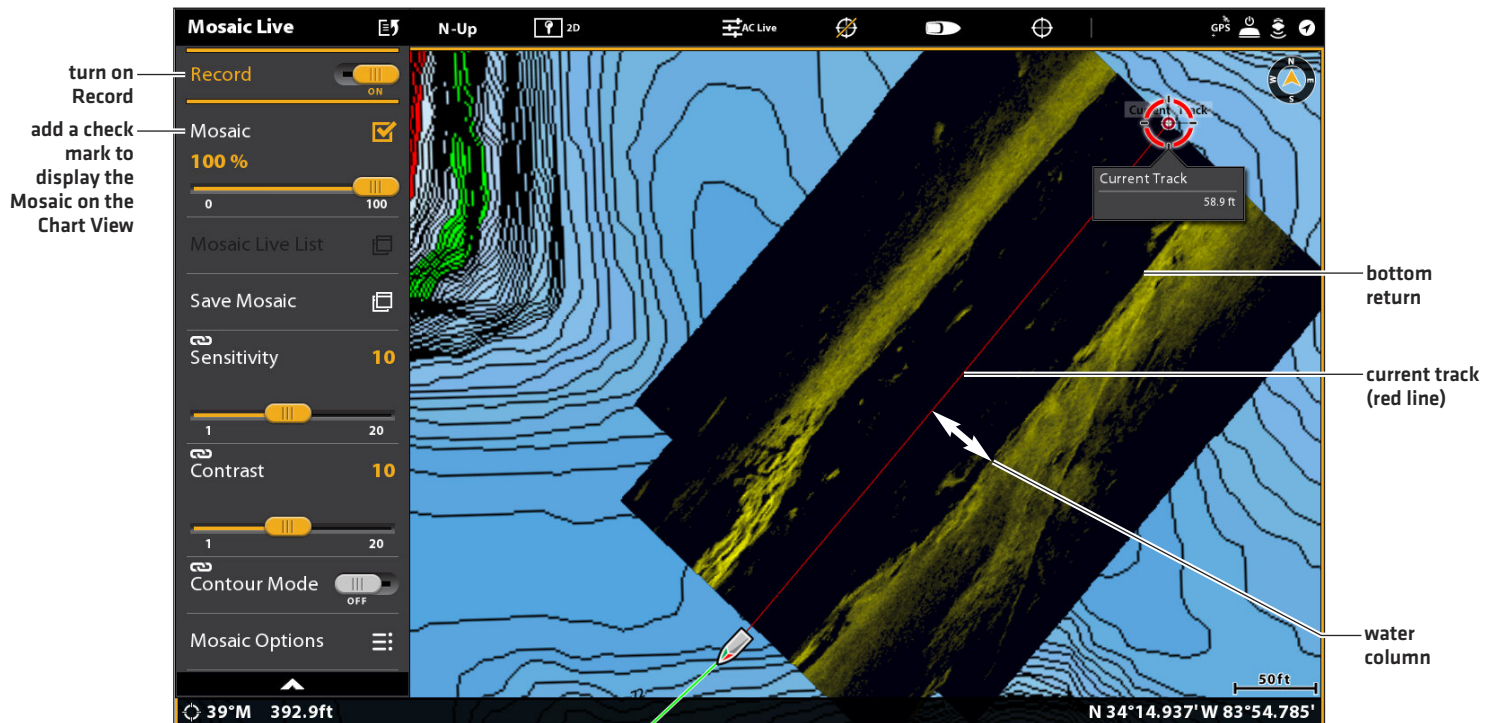

CUSTOMIZE THE MOSAIC LIVE DISPLAY

You can display or hide a Mosaic, and you can adjust the Mosaic Live display settings while it is being recorded or when it is loaded on the Chart View.

Display/Hide the Mosaic Live Overlay

Use the instructions in this section to display or hide the Mosaic overlay. You can also adjust the transparency.

1. From the Mosaic Live menu, select Mosaic.
2. **Display:** Tap the check box, or press the ENTER key, to add a check mark to it.
Hide: Tap the check box, or press the ENTER key, to remove the check mark.
3. **Adjust the Overlay Transparency:** Press and hold the slider, or press and hold the ENTER key.

Adjusting the Mosaic Overlay Transparency

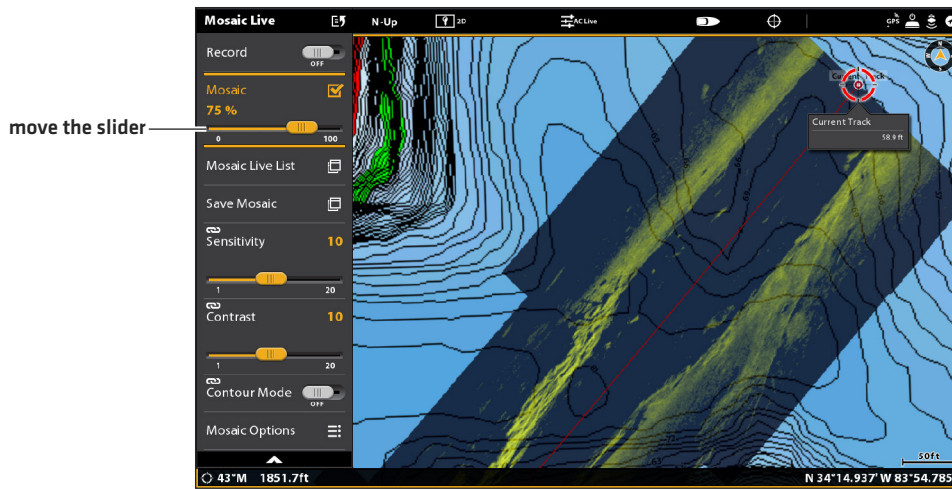

Load a Saved Mosaic

Use the instructions in this section to display a saved Mosaic. Mosaics can be displayed from a SD Card.

1. From the Mosaic Live menu, select Mosaic Live List.
2. Select the location where the SD card is installed [SD Card 1 or SD Card 2].
3. Select the Mosaic file.

Change the Palette

The Palette menu changes the colors used to display the Mosaic. The palette can be changed while a Mosaic is being recorded, or it can be applied to a saved Mosaic on the Chart View.

1. From the Mosaic Live menu, select Mosaic Options.
2. Select Palette.
3. Select a color palette.

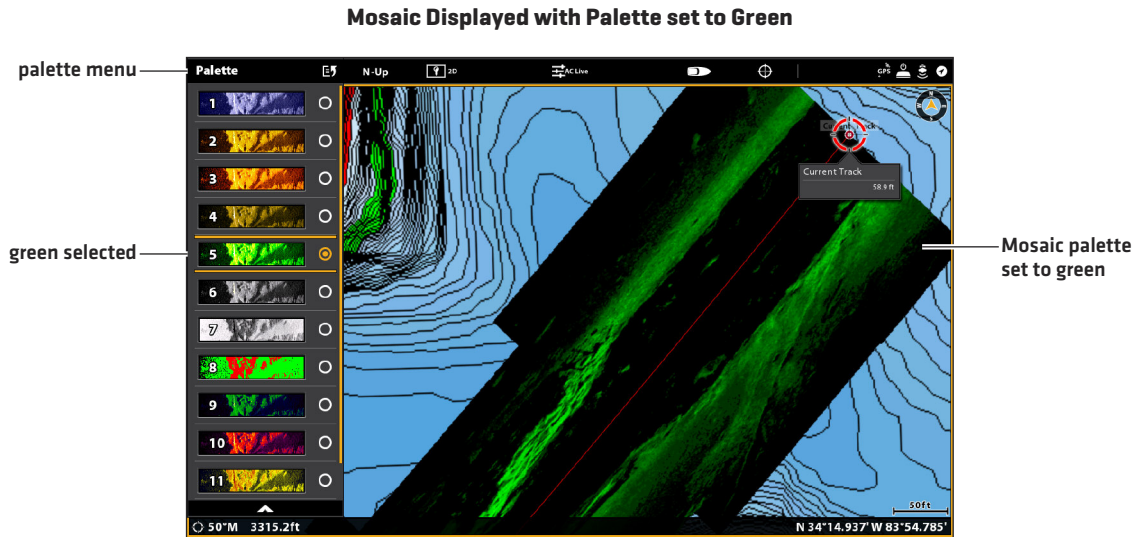

Change the Drawing Mode

You can also change how the Mosaic is drawn on the Chart View while it is being recorded.

1. From the Mosaic Live menu, select Mosaic Options.
2. Select Drawing Mode.
3. Select one of the following options:

Overwrite	If the boat travels over the same area, the old data will be deleted, and the most recent data will be displayed.
Blend	If the boat travels over the same area, AutoChart LIVE will mix the old data and new data on the display.
Keep Maximum	If the boat travels over the same area, AutoChart LIVE will prioritize the strong returns over the weak returns on the display.
Keep Nearest	If the boat travels over the same area, AutoChart LIVE will display the data closest to the boat.

Turn on/off Gain Correct

Turn on Gain Correct to automatically tune the transducer signal and filter any clutter that may show up in the Mosaic Live data.

1. From the Mosaic Live Menu, select Mosaic Options.
2. Select Gain Correct.
3. Tap the on/off button, or press the ENTER key, to turn it on or off.

Adjust the Sensitivity and Contrast

The sensitivity and contrast can be adjusted while the Mosaic is being recorded or it can be adjusted when a saved Mosaic is loaded onto the Chart View.

Adjusting the Sensitivity and Contrast

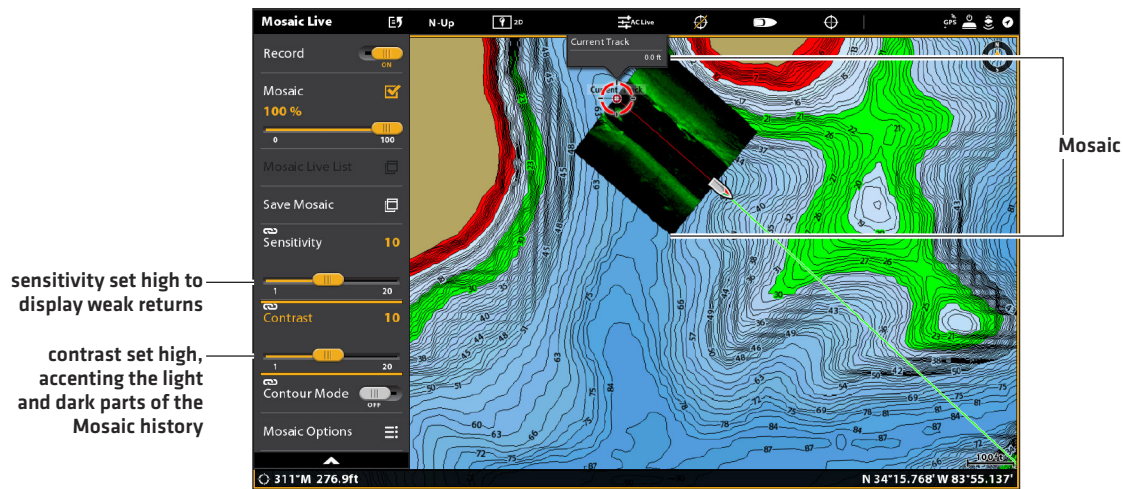

Adjust the Sensitivity and Contrast

1. From the Mosaic Live Menu, select Sensitivity or Contrast.
2. Press and hold the slider, or turn the Rotary dial, to adjust the setting.

Sensitivity	Sensitivity controls how much detail is shown on the display and will adjust the sensitivity of all sonar frequencies. Decrease the sensitivity to eliminate the clutter from the display that is sometimes present in murky or muddy water. When operating in very clear water or greater depths, increase the sensitivity to see weaker returns that may be of interest.
Contrast	Adjust the Contrast setting to accent the light and dark parts of the Mosaic data to provide greater definition.

Turn on/off Contour Mode

Contour Mode controls how the water column is displayed in the Mosaic. The location of a target in the Mosaic is influenced by the Contour Mode setting. For more information, see *Customize the Side Imaging View: Turn on/off Contour Mode*.

When Contour Mode turned off, the water column is displayed on the view. The location of a target on the display is based on the slant range to the target.

When Contour Mode is turned on, the bottom is graphed at a constant point on the display, regardless of changes in depth. The Side Imaging beams are divided by a vertical line. The water column is removed from the view, which allows the display to show targets at their linear horizontal distance. The location of a target may be easier to interpret when the water column is removed.

Turn on/off Contour Mode

1. From the Mosaic Live menu, select Contour Mode.
2. Tap the on/off button, or press the ENTER key, to turn it on/off.

Off: The water column is displayed.

On: The water column is hidden.

AUTOPILOT OVERVIEW

The Humminbird autopilot (SC 110) connects to the control head network. The Humminbird autopilot system requires a separate purchase. For additional autopilot products and equipment, visit our Web site at humminbird.com.

SC 110 Humminbird Autopilot Nav Mode with Chartplotter Input

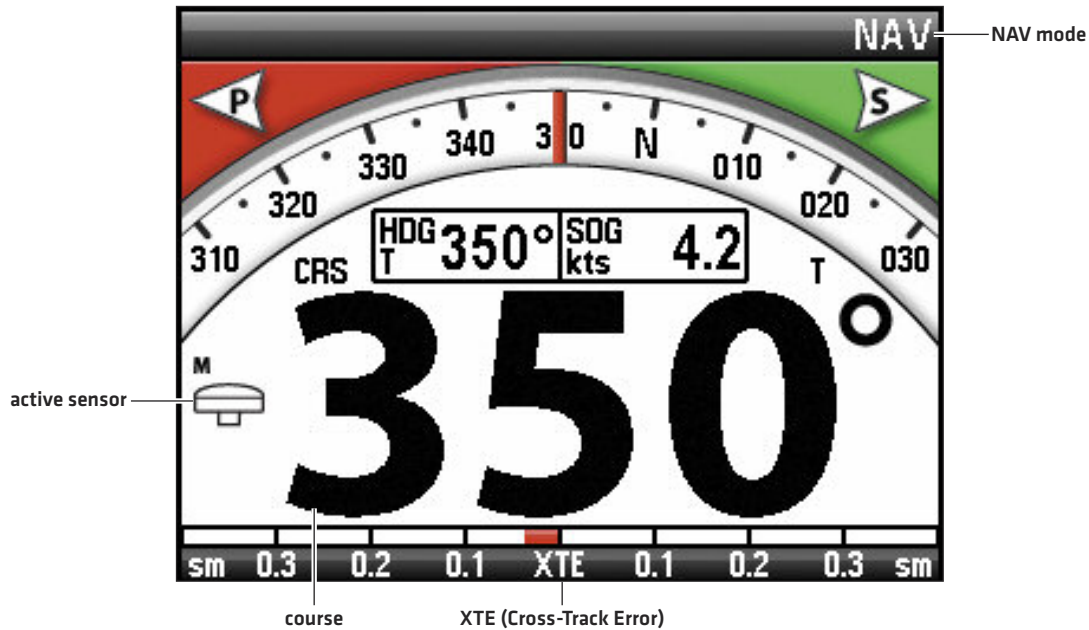

WARNING! It is the operator's responsibility to make prudent decisions regarding personal safety and the operation of the vessel. Do NOT leave the autopilot unattended while it is steering the vessel. Watch for obstacles and potential hazards at all times. Be prepared to respond to changing conditions and take manual control of the vessel as required.

WARNING! Do NOT use the autopilot where there may be shallow water, obstacles, or when manual navigation is required, especially in the following situations:

- while navigating or maneuvering in shallow waters or dangerous seabeds,
- while entering or exiting harbor, mooring, or setting sail,
- while traveling at high speed,
- in heavy traffic areas, near breakwaters, canals,
- or while encountering any potential obstacles.

Send Navigation Data to the Autopilot

When a route is started from the control head, it will communicate with the autopilot to tell it which way to turn to get on course. The Autopilot Navigation menu must be turned on to enable this feature on the control head.

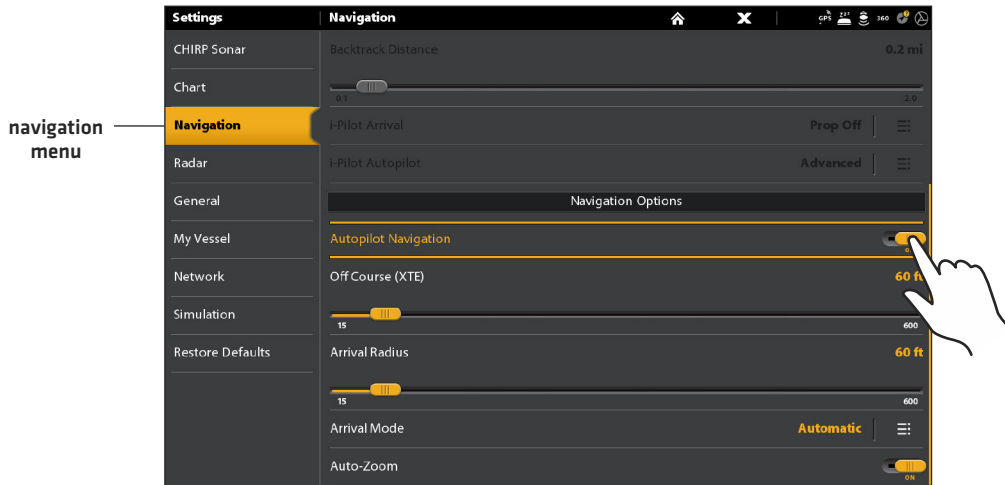

Enable Autopilot Navigation

Use the following instructions to enable Autopilot on the control head.

1. See *Installation Information: Configure the Control Head, Set up Autopilot*. The Autopilot must be set up correctly with the control head when it is first installed.
2. Press the HOME key.
3. Select Settings > Navigation.
4. Select Autopilot Navigation.
5. Tap the on/off button, or press the ENTER key, to turn it on.

Disable Autopilot Navigation

Use the following instructions to disable autopilot navigation. When Autopilot is disabled, the control head will not send data to the autopilot.

1. Press the HOME key.
2. Select Settings > Navigation.
3. Select Autopilot Navigation.
4. Tap the on/off button, or press the ENTER key, to turn it off.

RADAR OVERVIEW

The radar scanner must be connected to the control head to enable radar features. Some of the features also require a compass/heading sensor.

Some of the instructions in the following sections vary depending on the connected radar model. Refer to the instructions for your radar model as follows:

- Humminbird CHIRP Radar
- Humminbird Radar: RH 44, RH 45, AS 12RD2KW, and AS 21RD4KW

 **NOTE:** To configure the Humminbird radar after installation or equipment repair, see **Installation Information: Configure Humminbird Radar**. Humminbird CHIRP radar does not require configuration.

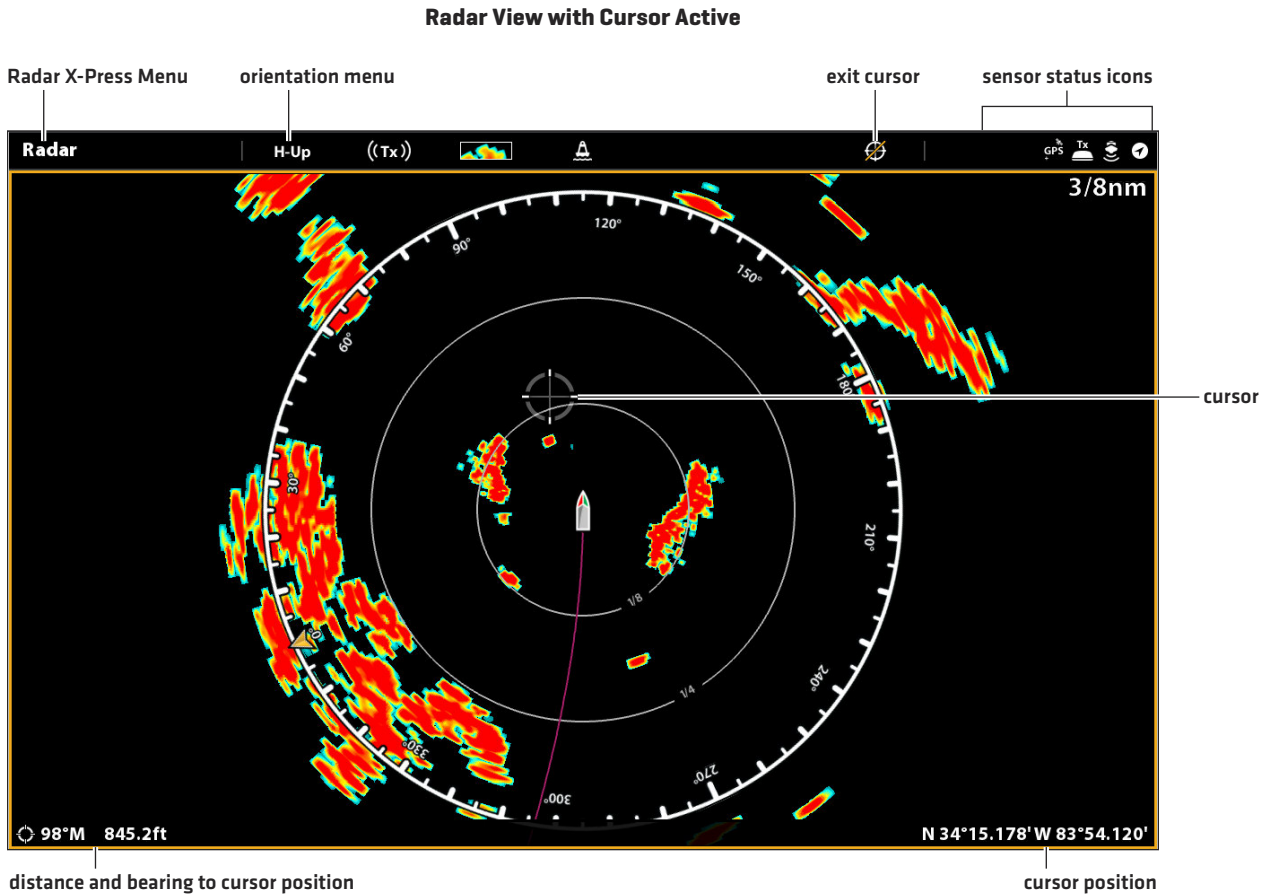

Tap to Activate the Cursor

OR

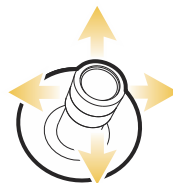

Move the Joystick to Activate the Cursor



Open the Cursor Menu

RADAR TRANSMISSION SETTINGS

The Radar Transmit menu can be accessed from the Power X-Press Menu, the Radar X-Press Menu, and the Radar tab in Settings.

Start/Stop Radar Transmission

Start Transmission: Humminbird CHIRP Radar

1. **Power On:** Turn on the radar power source [breaker or switch].
2. **Open the Power X-Press Menu:** Tap the top, right corner of the status bar.
OR
Press the POWER key.
3. Under Radar, select Standby.
4. **Reopen the Power X-Press Menu:** Repeat step 2. Under Radar, select Transmit.

Start Transmission: Humminbird Radar

1. **Power On:** Turn on the radar power source [breaker or switch].
2. Tap the top, right corner of the status bar.
OR
Press the POWER key.
3. Select Radar Transmit > On.

Stop Transmission

1. Tap the top, right corner of the status bar.
OR
Press the POWER key.
2. **Humminbird CHIRP Radar:** Under Radar, select Off.
Humminbird Radar: Select Radar Transmit > Off.
3. **Power Off:** Turn off the power source from the breaker or switch.

Starting Humminbird CHIRP Radar Transmission

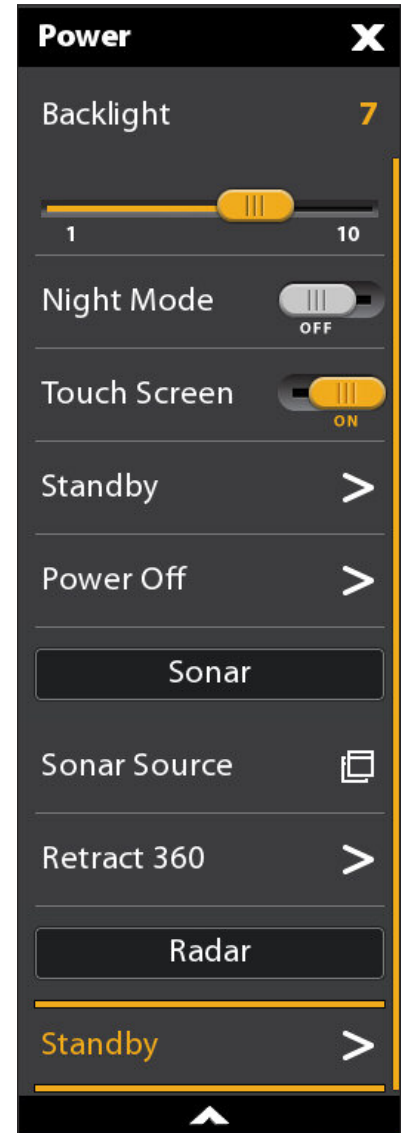

Select the Radar Mode (Humminbird CHIRP Radar only)

For optimum radar operation, select the radar mode for your current environment and weather. See the instructions below.

1. With a Radar View displayed on the screen, tap Radar in the status bar, or press the MENU key.
2. Select Mode.
3. Select from the menus shown below.

Harbor	Use in harbors and most inland areas.
Coastal	Use near the shoreline.
Offshore	Use when navigating several miles away from the shoreline.
Weather	Use when tracking rain and/or cloud cover.



QUICK TIP! You can also select this menu on the status bar.

Set up Timed Transmission Settings

Set up Timed Transmission Settings: Humminbird CHIRP Radar

1. Press the HOME key.
2. Select Settings.
3. Select Radar.
4. Select Timed Transmit, and turn it on.
5. Select Transmit Cycles. Select the number of cycles that the radar will transmit during Timed Transmission mode.
6. Select the Back icon to return to the previous menu, or press the EXIT key.
7. Select Standby Time. Set the amount of time that the radar will pause between transmissions in Timed Transmission mode.

Set up Timed Transmission Settings: Humminbird Radar

1. Press the HOME key.
2. Select Settings.
3. Select Radar.
4. Select Timed Transmit, and turn it on.
5. Select Transmit Time. Set the the amount of time that the radar will transmit during Timed Transmission mode.
6. Select the Back icon to return to the previous menu, or press the EXIT key.
7. Select Standby Time. Set the amount of time that the radar will pause between transmissions in Timed Transmission mode.

ADJUST THE TRANSMISSION RANGE

The scanner transmission range can be adjusted from the X-Press Menu or by pressing the +/- ZOOM keys. The range setting affects all the Radar Views in the control head. The control head will default to the largest chosen area from all of the Radar Views.

Adjust the Range with the Keypad

1. **Keypad:** Press the [+] key or [-] key to increase or decrease the transmission range.

Adjust the Range with the Menu System

This menu is available in Custom Mode [see *The Menu System: Change the User Mode*].

1. With the Radar View displayed on-screen, tap Radar in the status bar, or press the MENU key once.
2. Select Transmit Range.
3. Select a range from the menu.

RADAR ALARMS

When an alarm is turned on, it will use the control head's default setting to provide an alert, and you can also adjust the settings used to trigger an alarm. If you will be tracking targets with MARPA or AIS, see **AIS and MARPA**.

Turn on Radar Alarms

1. Press the HOME key.
2. Select Alarms.
3. Select Alarms > Targets.
4. Under Radar, select an alarm. Tap the on/off button, or press the ENTER key, to turn it on.

Dangerous Target	Turn on Dangerous Target to receive an alert if a MARPA target tracked as dangerous is detected in the radar transmission range. See AIS and MARPA for more information.
Lost Target	Turn on Lost Target to receive an alert if a tracked MARPA target has changed to lost in the radar transmission range. A target may be lost if its signal has not been received in the last 30 seconds. See AIS and MARPA for more information.
Guard Zone [Sector]	Turn on Guard Zone [Sector] to receive an alert when a radar return or MARPA target enters the guard zone sector. See Set the Guard Zone for details.
Guard Zone [Circle]	Turn on Guard Zone [Circle] to receive an alert when a radar return or MARPA target enters the guard zone circle. See Set the Guard Zone for details.

To adjust the Transmission range, see **Adjust the Transmission Range**.

To set the Guard Zone, see **Set the Guard Zone**.



NOTE: You can also turn on AIS alarms from this menu. See **AIS and MARPA** for more information.

Set the Guard Zone

If you turned on the Guard Zone alarms in the Alarms tool, use this section to display the Guard Zone and adjust the settings that will trigger the alarm. The settings in this section are optional. You can turn on the Guard Zone alarms and receive alerts using the control head default settings. **This menu is available in Custom Mode** [see *The Menu System: Change the User Mode*].

1. Press the HOME key.
2. Open a Radar View.
3. Start Radar Transmission.
4. Tap Radar in the status bar, or press the MENU key once.
5. Select Guard Zone.
6. Turn on Circle or Sector. [Tap the on/off button, or press the ENTER key, to turn it on.]
7. Select Adjust Circle or Adjust Sector.

Circle [radius]: Use the Joystick to adjust the radius. Press the ENTER key to set the guard zone. A preview of the guard zone will be highlighted between the dotted lines.

Sector [angular]: Use the Joystick to move the cursor to a position on the Radar View. Press the ENTER key to select the first corner of the guard zone. Repeat to select the second corner of the guard zone. A preview of the guard zone will be highlighted between the dotted lines.

8. Select Alarm Sensitivity to adjust the sensitivity to targets in the guard zone. Press and hold the slider, or turn the Rotary dial, to adjust the range, where 1 = low sensitivity and 100 = high sensitivity.

Turn off the Guard Zone

1. Press the HOME key.
2. Open a Radar View.
3. Tap Radar in the status bar, or press the MENU key once.
4. Select Guard Zone.
5. Select Circle, and turn it off.
Select Sector, and turn it off.

Setting the Guard Zone Sector (Keypad)

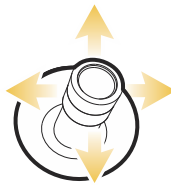
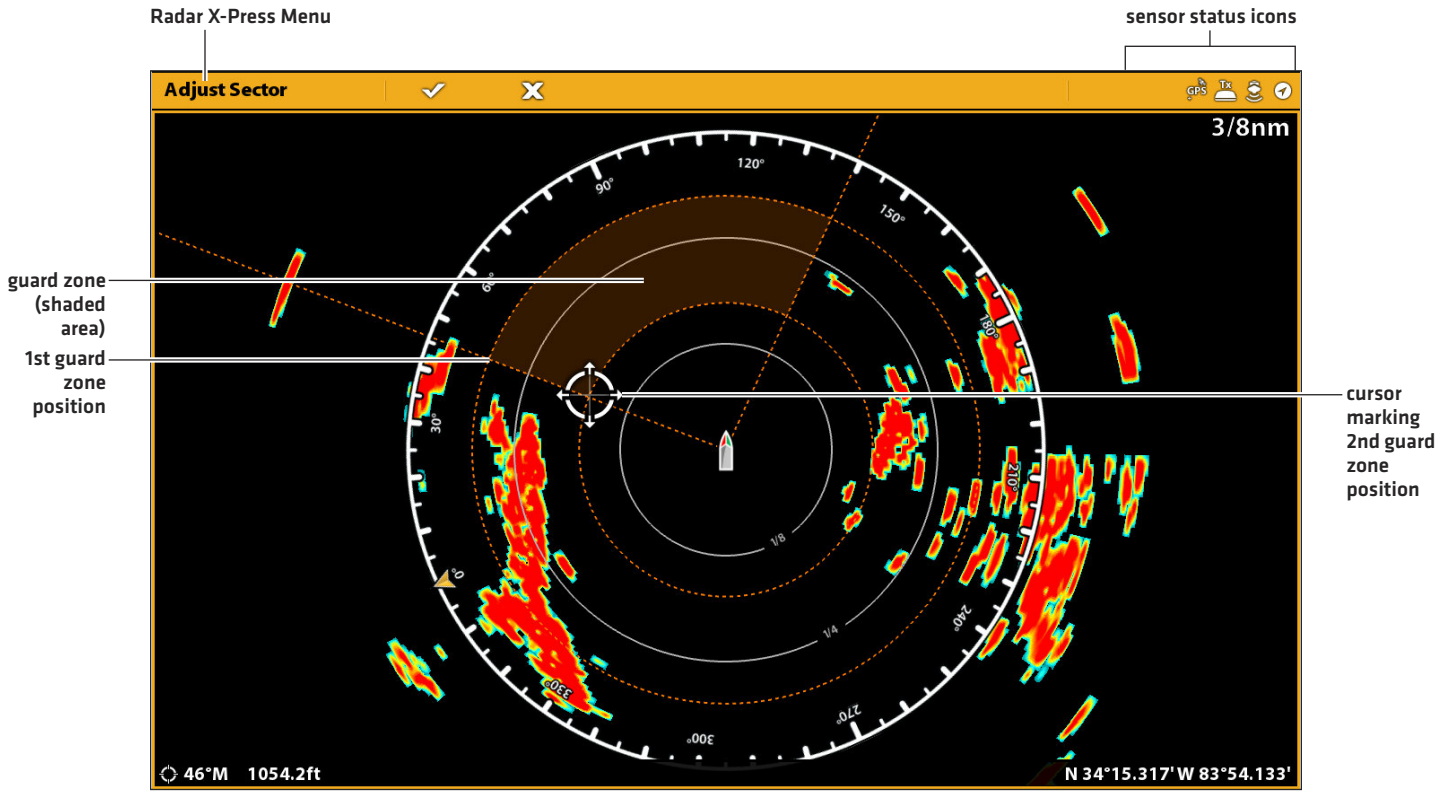

Select a Position



Confirm

CUSTOMIZE THE RADAR VIEW

The settings in this section are optional. You can use the default settings for the Radar View, or you can customize it with your preferences. See **Views** for more information.

OPEN THE RADAR PREFERENCES MENU

The Preferences menu allows you to set the Radar View orientation, vessel offset, and display colors. For more information about view preferences, see **Views**.

1. With a Radar View displayed on-screen, tap Radar in the status bar, or press the MENU key once.
2. Select Radar Options.
3. Select Preferences.

Set the Chart Orientation

Use the Preferences menu to change the chart orientation. You can also select the orientation menu on the status bar.

1. From the Preferences menu, select Orientation.
2. Select an orientation to apply to the chart.

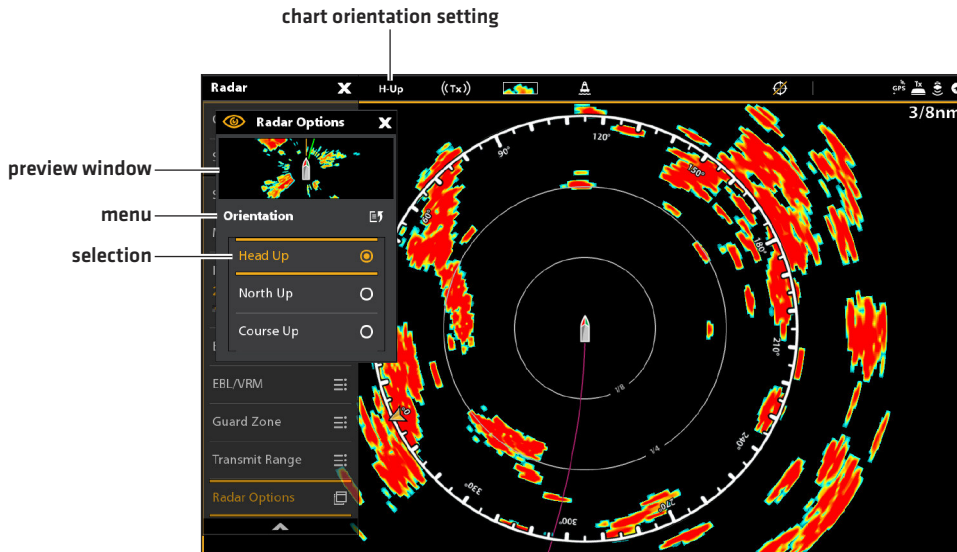

Head Up	The vessel's current heading points up, and the chart rotates around the vessel icon so that it always points up on the view. The heading is provided by the connected compass/heading sensor. If a compass is not connected, the heading will be calculated using the GPS receiver's COG [Course Over Ground].
North Up [compass required]	True north is shown at the top of the display and the vessel rotates on the screen to point towards the current heading.
Course Up	During navigation, the projected course is shown at the top of the view. Objects ahead of the vessel are drawn above the vessel. When the vessel is not navigating, the course-up reference is provided by a one-time COG [Course Over Ground] calculation.

Change Radar Display Colors

The Radar Colors menu changes the palette used to display radar returns. The Background Colors menu changes the color of the background on Radar Views.

1. From the Preferences menu, select Radar Colors or Background Colors.
2. Select a color palette or background color.



NOTE: The available options may vary depending on your radar model.

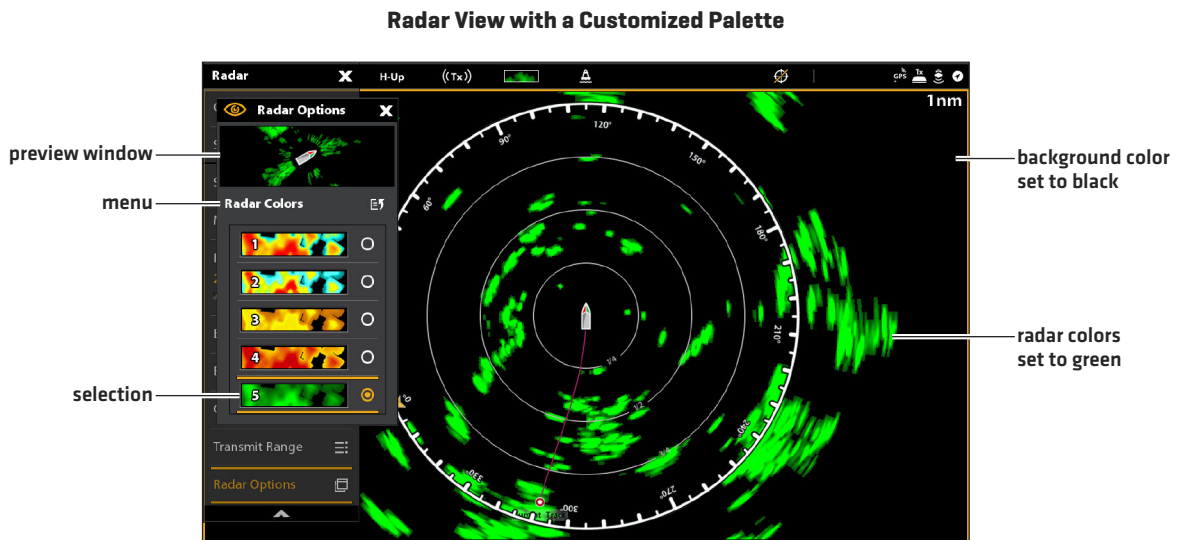

Radar Colors: The palettes in this menu are listed weakest return to strongest return, as follows:

Red	dark green [weak], light green [medium], orange [strong], red [strongest]
Yellow	dark green[weak], green [medium], yellow [strong]
Green	dark green [weak], green [medium], light green [strong]
Magenta	red [weak], crimson [medium], magenta [strong], pink [strongest]

CHANGE THE RADAR VIEW OVERLAYS

Use the Overlays menu to display or hide information on the view. In a Radar View, you can display or hide range rings, range symbols, the compass ring, north indicator, and EBL/VRM readout box. You can also display or hide vessel data, AIS and MARPA targets, navigation data, and the data overlay. The available menu options are determined by the equipment connected to the control head network. Also, see **Views** for more information about Overlays.

1. With a Radar View displayed on-screen, tap Radar in the status bar, or press the MENU key once.
2. Select Radar Options.
3. Select Overlays.
4. Tap the menu or use the Joystick to select an item and add a check mark. [check mark = visible, blank = hidden].

Display Range Rings

1. From the Overlays menu, select Range Rings.
2. Tap the menu, or press the ENTER key, to add a check mark to the box.

Display Vessel Icons

The Vessel Overlay allows you to display the vessel icon with other visual information such as the heading line, COG [Course over Ground], Rate of Turn, and Drift Limit.

1. From the Overlays menu, select Vessel.
2. Select Show. Tap the on/off button, or press the ENTER key, to turn it on.
3. Tap the menu name, or press the ENTER key, to add a check mark to the box.

Display AIS and MARPA Targets

The Targets Overlay displays or hides AIS targets, MARPA targets, and the Safe Zone. An AIS must be connected to enable AIS targets on the view. See **AIS and MARPA** for more information.

1. From the Overlays menu, select Targets.
2. Select Show. Tap the on/off button, or press the ENTER key, to turn it on.
3. Select MARPA and/or AIS, and add a check mark to each box.
4. To display the Safe Ring, tap the menu name, or press the ENTER key, to add a check mark to the box.

Display Navigation Data

Use the Nav Data Overlay to display waypoints, routes, and tracks on the Radar View. See **Introduction to Navigation** for more information.

1. From the Overlays menu, select Nav Data.
2. Select Show. Tap the on/off button, or press the ENTER key, to turn it on.
3. Tap the navigation data types, or press the ENTER key, to add a check mark to the box.

Display the Data Overlay

Digital readout data can be displayed as an overlay, and it can be displayed in the data bar. To turn on the data bar, see **Views: Display a Data Bar**. For more information about data overlays, see **Views**.

1. From the Overlays menu, select Data Overlay.
2. Select Show. Tap the on/off button, or press the ENTER key, to turn it on.
3. Tap the menu name, or use the Joystick, to select an item and add a check mark.

Radar View with Overlays Displayed

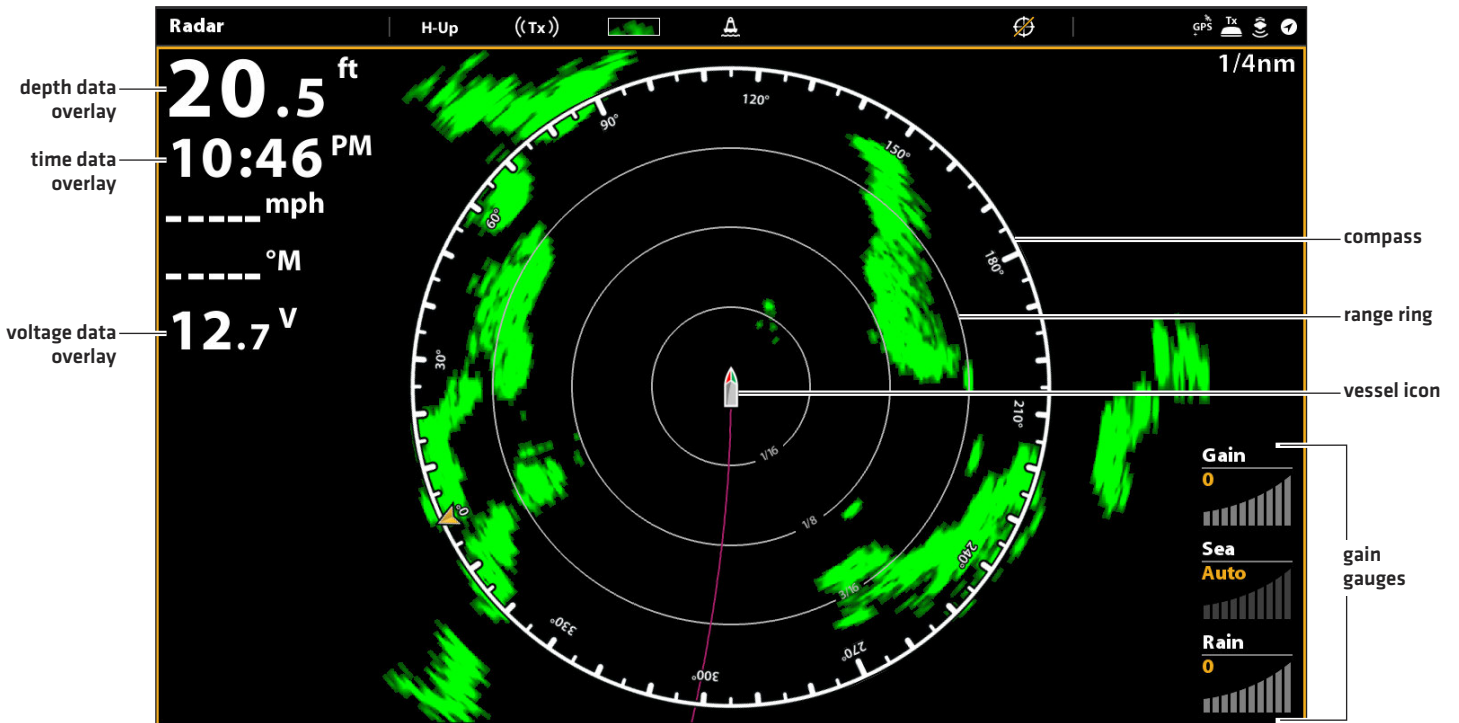

ADJUST RADAR SIGNAL SETTINGS

Use the settings in this section to filter the returns on the display or increase the amount of returns on the display.

Adjust the Gain Setting

Use the Gain setting to adjust the sensitivity of the radar. Increase the gain to see more targets on the view, and decrease the gain to reduce the clutter caused by rain or snow.

1. With a Radar View displayed on-screen, tap Radar in the status bar.

OR

Press the MENU key.

2. Select Settings.
3. Select Gain.
4. Tap the Auto/M button to select Auto or Manual, or press the ENTER key.

Manual: If you select Manual, press and hold the slider, or press and hold the ENTER key, to adjust the setting.



QUICK TIP! You can also change this setting by turning the Rotary dial. See the illustration below.

Changing the Gain Setting Using the Rotary Dial

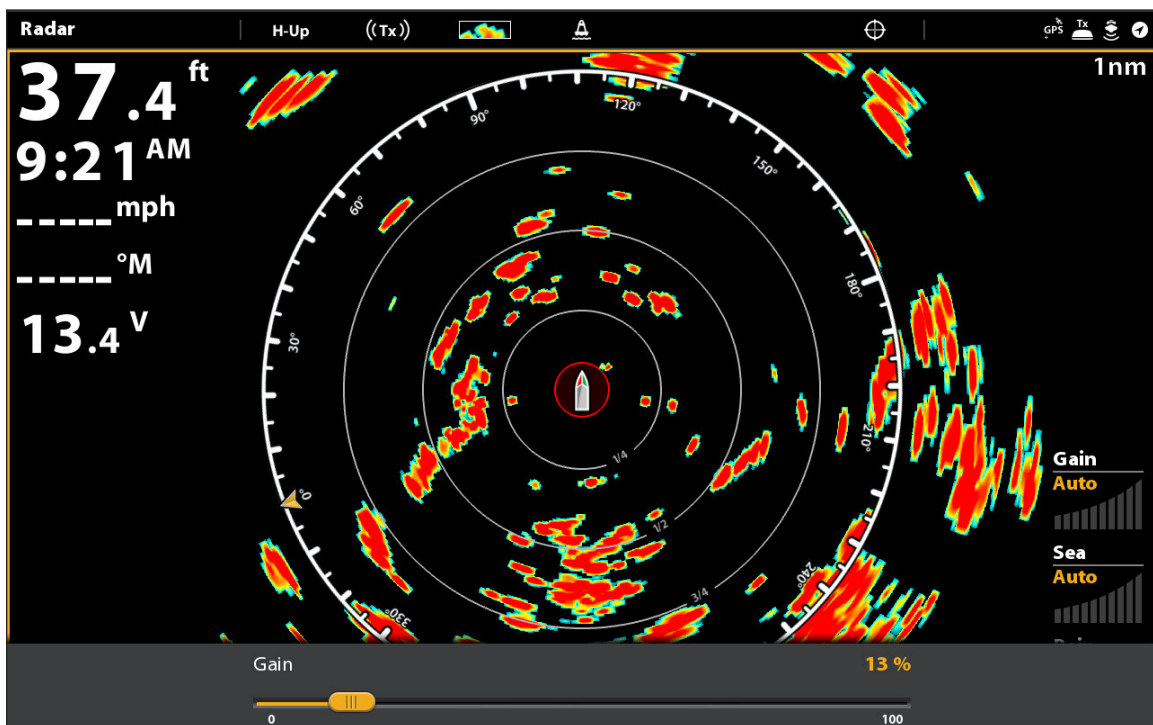

Select a Setting

Adjust the Color Gain Setting (Humminbird CHIRP Radar only)

Use Color Gain to adjust the contrast of the radar returns on the display.

1. With a Radar View displayed on-screen, tap Radar in the status bar.

OR

Press the MENU key.

2. Select Settings.
3. Select Color Gain.
4. Tap the Auto/M button to select Auto or Manual, or press the ENTER key.

Manual: If you select Manual, press and hold the slider, or press and hold the ENTER key, to adjust the setting.

Adjust the Sea Clutter Setting

Use the Sea Clutter setting to reduce the clutter that may appear on the view during rough sea conditions.

1. With a Radar View displayed on-screen, tap Radar in the status bar.

OR

Press the MENU key.

2. Select Settings.
3. Select Sea.
4. Tap the Auto/M button to select Auto or Manual, or press the ENTER key.

Manual: If you select Manual, press and hold the slider, or press and hold the ENTER key, to adjust the setting.

Adjust Rain Clutter Settings

Use the Rain Clutter setting to reduce the clutter on the view caused by rain or snow.

1. With a Radar View displayed on-screen, tap Radar in the status bar.

OR

Press the MENU key.

2. Select Settings.
3. Select Rain.
4. Tap the on/off button to select On, or press the ENTER key. Press and hold the slider, or press and hold the ENTER key, to adjust the setting.

Adjust Interference Rejection

Use the Interference Rejection setting to reduce the noise or interference from other transmitting radars in the area.

1. With a Radar View displayed on-screen, tap Radar in the status bar.

OR

Press the MENU key.

2. Select Interference Rejection.
3. Press and hold the slider, or press and hold the ENTER key, to adjust the setting.

EBL/VRM

Use EBL [Electronic Bearing Range] and VRM [Variable Range Ring] to measure the distance and bearing between any two targets on the Radar View.

The EBL and VRM can be set as a pair, and you can set two pairs. The marker is tied to the center of the vessel. As the vessel's position and heading move, the EBL/VRM also moves.

This menu is available in Custom Mode [see *The Menu System: Change the User Mode*].

Create an EBL/VRM

1. With a Radar View displayed on-screen, tap Radar in the status bar.

OR

Press the MENU key.

2. Select EBL/VRM.
3. Select EBL/VRM, and turn it on.
4. Select Adjust.
5. Use the Joystick to move the cursor until it is positioned over the chosen EBL/VRM intersection.
6. Press the ENTER key.

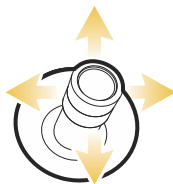
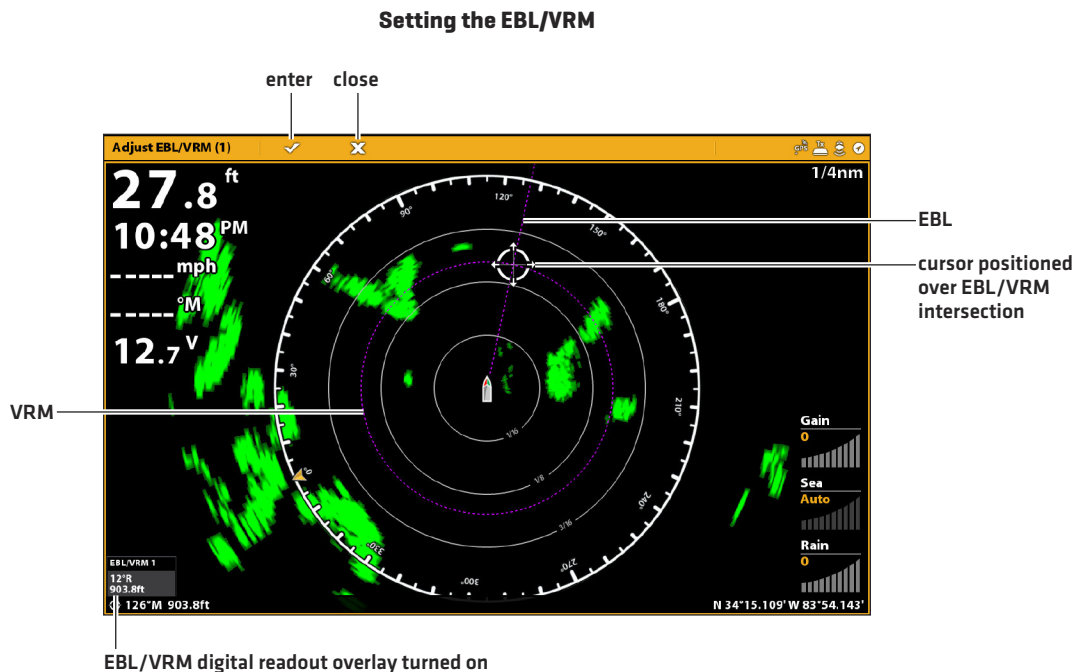

Select a Position



Enter

Edit an EBL/VRM

1. With a Radar View displayed on-screen, tap Radar in the status bar.

OR

Press the MENU key.

2. Select EBL/VRM.
3. Under EBL/VRM, select Adjust.
4. Use the Joystick to move the cursor until it is positioned over the chosen EBL/VRM intersection.
5. Press the ENTER key.

Turn off an EBL/VRM

1. With a Radar View displayed on-screen, tap Radar in the status bar.

OR

Press the MENU key.

2. Select EBL/VRM.
3. Select EBL/VRM, and turn it off.

NAVIGATION IN RADAR VIEW

You can mark waypoints and start navigation from the Radar View. See *Introduction to Navigation* for more features and information.



NOTE: To display navigation data on the Radar View, see *Change the Radar View Overlays: Display Navigation Data*.

Mark a Waypoint

There are a variety of ways to mark a waypoint in the Radar View. The basic instructions are shown here. See *Introduction to Navigation* for more features and information.

Mark a Waypoint at the Vessel Position

Touch Screen

1. Tap Radar in the status bar.
2. Select Mark.
3. Select Waypoint.

Keypad

1. Press the MARK key twice.

Mark a Waypoint at the Cursor Position

Touch Screen

1. Press and hold a position on the Radar View.
2. Select Waypoint.

Keypad

1. Use the Joystick to move the cursor to a position on the chart.
2. Press the MARK key twice.

Start Navigation

There are a variety of ways to start navigation in the Radar View. The basic instructions are shown here. See *Introduction to Navigation* for more features and information.

Start Quick Route Navigation

Touch Screen

1. Tap Radar in the status bar.
2. Select Go To.
3. Select Quick Route.
4. Tap the chart in the positions where you want to mark a route point.

Undo Last Route Point: Tap the Back icon.

Cancel Route Creation: Tap the X icon.

5. To start navigation, tap the check icon in the status bar.

Keypad

1. Press the GO TO key.
2. Select Quick Route.
3. Use the Joystick to move the cursor to a position or waypoint. Press the Joystick to mark the first route point.

4. Repeat Step 3 to connect more than one route point.

Undo Last Route Point: Press the EXIT key once.

Cancel Route Creation: Press and hold the EXIT key.

5. To start navigation, press the ENTER key.

AIS AND MARPA

AIS and MARPA allow the control head to display targets on the Chart and Radar Views. While AIS and MARPA share many of the same menus and functions, some of the requirements and operations are different for each feature.

AIS: Targets within the AIS VHF transmission range are displayed on Chart and Radar Views. An AIS and a compass/heading sensor must be connected to the control head to enable this feature. The control head can track up to 100 targets at the same time. If more than 100 targets are reported by the AIS equipment, the first 100 targets closest to your vessel will be shown. See **AIS Overview** for more information.

MARPA: Targets are displayed and tracked on the Radar View. A Radar scanner and compass/heading sensor must be attached to the control head to enable MARPA, and the control head can track up to 20 targets at the same time. See **MARPA Targets** for more information.

AIS AND MARPA ALARMS

When an alarm is turned on, an alert will sound or display on the control head to indicate the threshold has been exceeded. The alarm will use the control head's default setting to provide the alert, and you can also adjust the alarm settings used to trigger an alarm. The alarms for AIS and MARPA are also affected by the Guard Zone. To set the Guard Zone, see **Radar Alarms**.

Turn on AIS Alarms

1. Press the HOME key.
2. Select Alarms.
3. Select Alarms > Targets.
4. Under AIS, select an alarm and turn it on. (Tap the on/off button, or press the ENTER key, to turn it on.)

Dangerous Target	Turn on Dangerous Target to receive an alert if a dangerous target is detected within the AIS transmission range.
Lost Target	Turn on Lost Target to receive an alert if a target has changed to lost within the AIS transmission range. A target may be lost if its signal has not been received in the last 8 minutes.
Guard Zone [Sector]	Turn on Guard Zone [Sector] to receive an alert when a target enters the guard zone sector. See Radar Alarms to set the Guard Zone.
Guard Zone [Circle]	Turn on Guard Zone [Circle] to receive an alert when a target enters the guard zone circle. See Radar Alarms to set the Guard Zone.

Turn on MARPA Alarms

For a MARPA target to be detected, the radar must be transmitting and a return must be identified as a target. The settings in this section are shared with Radar.

1. Press the HOME key.
2. Select Alarms.
3. Select Alarms > Targets.
4. Under Radar, select an alarm and turn it on. [Tap the on/off button, or press the ENTER key, to turn it on.]

Dangerous Target	Turn on Dangerous Target to receive an alert if a MARPA target tracked as dangerous is detected in the radar transmission range.
Lost Target	Turn on Lost Target to receive an alert if a tracked MARPA target has changed to lost in the radar transmission range. A target may be lost if its signal has not been received in the last 30 seconds.
Guard Zone [Sector]	Turn on Guard Zone [Sector] to receive an alert when a radar return or MARPA target enters the guard zone sector. See Radar Alarms to set the Guard Zone.
Guard Zone [Circle]	Turn on Guard Zone [Circle] to receive an alert when a radar return or MARPA target enters the guard zone circle. See Radar Alarms to set the Guard Zone.

Set the Safe Zone

Use the Safe Zone to set how close targets may approach your vessel. If a target crosses into the Safe Zone, its status will change to Dangerous. You can set the size of the safe zone around the vessel in nautical miles or time. To display the Safe Zone on the Radar View or Chart View, see **Display the Safe Zone**.

1. Press the HOME key.
2. Select the Targets tool.
3. Select Settings > Safe Zone [Range] or Safe Zone [Time].

Safe Zone [Range]: Select the closest point of approach by another vessel [based on CPA [Closest Point of Approach] and TCPA [Time to Closest Point of Approach]]. The amount is estimated in nautical miles, and the value determines the safe zone radius.

Safe Zone [Time]: Select the closest point of approach, measured in time.

AIS AND MARPA DISPLAY SETTINGS

Display AIS and MARPA Targets

Use the following instructions to display AIS or MARPA Targets on the Chart View or Radar View.



NOTE: If Automatic AIS Tracking is turned on, but you do not see AIS targets on the chart and Radar Views, use these instructions to make sure targets are set to display in the Overlays menu.

1. With a Radar View or Chart View displayed on-screen, tap Radar or Chart in the status bar.

OR

Press the MENU key once.

2. Select Radar Options or Chart Options.
3. Select Overlays.
4. Select Targets.
5. Select Show, and turn it on.
6. Select MARPA and/or AIS, and add a check mark to each box.

Display the Safe Ring

The Safe Ring is displayed on the Radar View or Chart View to indicate the safe zone range. The range is highlighted in red. To change the range of the safe zone, see *AIS and MARPA Alarms: Set the Safe Zone*.

1. With a Radar View or Chart View displayed on-screen, tap Radar or Chart in the status bar.

OR

Press the MENU key once.

2. Select Radar Options or Chart Options.
3. Select Overlays.
4. Select Targets.
5. Select Show, and turn it on.
6. Select Safe Ring and tap it, or press the ENTER key, to add a check mark to the box.

Chart View with the Safe Ring Displayed

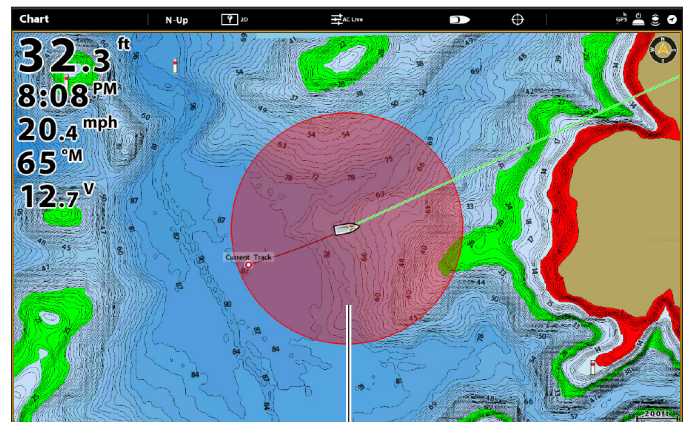

safe zone

Set Target Display Settings

In both AIS and MARPA, when a target is identified, it is displayed on the screen with an icon that indicates the target's safety status. You can set defaults for how the targets will display on the screen.

1. Press the HOME key.
2. Select the Targets tool.
3. Select Settings > Target Settings.

COG Vector	The COG Vector displays a line extending from the target that indicates the last known ship speed. If you turn on Auto Show, the line is displayed when you select the target with the cursor [see <i>Track AIS Targets</i>].
Sleeping Target (Speed)	Use this menu to set the speed a target must reach for it to be identified as a sleeping target.
Rate of Turn	Use this menu to set the turning threshold for the rate of turn icon to be displayed. If the threshold is met, the target's turn icon (port or starboard) will be displayed.
Clear Lost Target (Time)	Use this menu to set the amount of time a target will remain on the view after it is identified as a lost target.

AIS OVERVIEW

When an AIS is connected to the control head network, targets within the AIS VHF transmission range are displayed on the Chart and Radar Views. An AIS and compass/heading sensor are required to enable this feature.

The AIS tracks up to 100 targets at once. The AIS also exchanges information with the targets, including vessel identification, position, course, and speed. When a target exits the AIS transmission range, the information will be cleared automatically.

 **NOTE:** In some cases, vessel data may not be available. The information received from other vessels is determined by the vessel class [Class A = required, Class B = optional], their AIS equipment, and the information the captains choose to transmit.

AIS Broadcast Settings

Your AIS also broadcasts data to vessels within the transmission range. To view your call sign, class, type, position, heading, MMSI [Maritime Mobile Service Identity], and more, open the My AIS Info dialog box.

Open the My AIS Info Dialog Box

1. Press the HOME key.
2. Select Settings.
3. Select My Vessel.
4. Select My AIS Info.

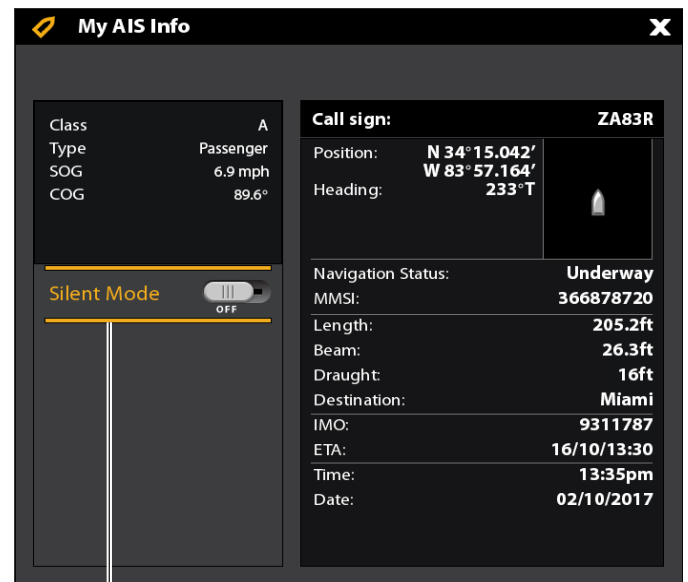

silent mode can be turned on from this dialog box

Turn on/off Silent Mode

If Silent Mode is turned on, your vessel's AIS information will not be broadcast to other vessels. In this case, your AIS is only receiving data from other vessels in the area.

If Silent Mode is turned off, your vessel's AIS information is broadcasted to other vessels, so the AIS is receiving and transmitting.

Silent mode can be turned on or off from the My AIS Info dialog box, or you can use the following instructions.

1. Press the HOME key.
2. Select the Targets tool.
3. Select Settings > Silent Mode. [Default = Off]

 **NOTE:** Silent Mode might not be supported by your AIS equipment. See your AIS installation manual for more information.

AIS Filter Settings

You can also control how many AIS targets are shown on the view by adjusting the filter settings.

Turn on/off Range Filter

If Range Filter is turned on, targets are displayed from your vessel to the distance you set. Targets outside of the range will not be displayed.

If Range Filter is turned off, targets will be displayed within the full range of the AIS equipment's transmission capabilities.

1. Press the HOME key.
2. Select the Targets tool.
3. Select Settings > Range Filter. Tap the on/off button, or press the ENTER key, to turn it on/off.
4. Press and hold the slider, or press and hold the ENTER key, to adjust the setting.

Turn on/off Class B Filter

If Class B Filter is turned on, Class B targets will not be shown. If Class B filter is turned off, all available AIS targets will be shown.













1. Press the HOME key.
2. Select the Targets tool.
3. Select Settings > Class B Filter. Tap the on/off button, or press the ENTER key, to turn it on/off.

AIS Targets

Each target is represented by an icon that indicates the vessel type. The color of the target icon is determined by the AIS Target Type shown on the AIS List. The target type shows its status with the following shapes and additional color details.



For example, the **Cargo Target** appearance will change depending on its status, and whether it is moving or anchored, as shown in the following table:

Underway Icon	Anchor Icon	Status	Description
		Dangerous	The target is active and detected as dangerous based on the CPA [Closest Point of Approach] and TCPA [Time to Closest Point of Approach]. The target is outlined in red.
		Uncertain	The target is active, but the calculated CPA [Closest Point of Approach] and TCPA [Time to Closest Point of Approach] have not been received in the last 4 minutes. The target is outlined in white.
		Sleeping	The target is active or inactive, and it is moving slower than the sleeping target threshold. To set the threshold see <i>AIS and MARPA: Set Target Display Settings</i> .
		Inactive	The target is identified and moving, but it is not being tracked by the AIS.
		Active	The target is identified, tracked, moving, and sending data to the AIS.
		Lost	The target is not available for tracking. A target may be lost if its signal has not been received in the last 8 minutes. The target will be grayed out and displayed with its last available position on the view. To adjust the lost threshold, see <i>AIS and MARPA: Set Target Display Settings</i> .



NOTE: See *Open the AIS Target List* for more information about the AIS List and the AIS Target Key.

Track AIS Targets

You can turn on tracking for all targets. You can also select individual targets and turn tracking on or off.

Turn on/off Automatic AIS Tracking

When Automatic AIS Tracking is turned on, all AIS targets are tracked within the equipment's capabilities.

When Automatic AIS tracking is turned off, all AIS targets are not tracked, but you can still track targets individually [see *Track a Selected Target*].

1. From the Home screen, select the Targets tool.
2. Select Settings > Automatic AIS Tracking. Tap the on/off button, or press the ENTER key.



NOTE: If Automatic AIS Tracking is turned on, but you do not see AIS targets on the Chart and Radar Views, make sure targets are set to display in the Overlays menu. See *Display AIS and MARPA Targets*.

Track a Selected Target

If Automatic AIS Tracking is turned off, you can select a target and track it individually. If Automatic AIS Tracking is turned on, Track Target [for individual target tracking] is not available in the menu system. See *Turn on/off Automatic AIS Tracking* for more information.

1. From the Home screen, select the Targets tool.
2. Under Lists, select AIS.
3. Press and hold a target, or use the Joystick to select it.
4. Select Track Target. Tap the on/off button, or press the ENTER key, to turn it on.

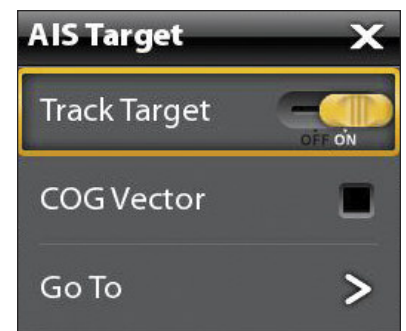

Cancel Tracking for a Selected Target

1. From the Home screen, select the Targets tool.
2. Under Lists, select AIS.
3. Press and hold a target, or use the Joystick to select it.
4. Select Track Target, and turn it off.

Change all Targets to Inactive (X-Press Menu)

Use the instructions in this section to cancel tracking from the X-Press Menu. This menu is available if Automatic AIS Tracking is turned off but individual targets are being tracked [see *Track a Selected Target*].

1. With a Chart View or Radar View displayed on-screen, tap Chart or Radar in the status bar. Select Info.

OR

Press the ENTER key.

2. Select AIS: All Inactive.

Change all Targets to Inactive (Targets Tool)

Use the instructions in this section to cancel tracking from the Targets tool. This menu is available if Automatic AIS Tracking is turned off but individual targets are being tracked [see *Track a Selected Target*].

1. Press the HOME key.
2. Select the Targets tool.
3. Select Cancel All AIS Targets.

Start Navigation to a Selected Target

Start navigation to a selected target using the following instructions. See *Introduction to Navigation* for more features and information.

Start Navigation to a Selected Target

Touch Screen

1. With a Chart View or Radar View displayed on-screen, tap a target to select it.
2. Tap Radar or Chart in the status bar, and select Go To.
3. Select Go To Cursor.

Keypad

1. With a Chart View or Radar View displayed on-screen, use the Joystick to move the cursor to a target.
2. Press the GO TO key.
3. Select Go To Cursor.



NOTE: You can also start navigation from the AIS List in the Targets tool. Select a target and press the MENU key, or press and hold the target name. Select Go To.

Open the AIS Target List

The AIS List is based on the last available transmission calculation and includes the targets' name, MMSI (Maritime Mobile Service Identity, Distance, Bearing, SOG, and Class. The AIS List can be opened in the Targets tool, or it can be opened in the Chart and Radar Views.

Open the AIS List from the Targets Tool

1. Press the HOME key.
2. Select the Targets tool.
3. Under Lists, select AIS.

Open the AIS List from a View

1. With a Chart View or Radar View displayed on-screen, tap Chart or Radar in the status bar. Select Info.

OR

Press the ENTER key.

2. Select AIS List.

AIS Target Data Received

The screenshot displays the AIS Target List interface. At the top, the title "AIS Target Data Received" is centered. Below it, a table lists several vessels with columns for Name, MMSI, Distance, Brg, SOG, Status, and Class. The first row is highlighted in yellow, indicating it is the selected target. To the right of the table, a detailed view for the selected target is shown, including vessel name, position, heading, length, beam, draught, destination, and date. Below the detailed view is an "AIS Target Key" section with various icons representing vessel types and statuses. The interface also includes a "Chart" view in the background and a "Full Info" panel on the left.

Name	MMSI	Distance	Brg	SOG	Status	Class
MAKING MEMORIES	265547250	0.0 ft	0°M	83.1 mph	Lost	A
ARCO AVON	664444000	0.0 ft	0°M	41.9 mph	Lost	A
M/Y "VAMOOSSE"	603916439	0.0 ft	0°M	90.7 mph	Lost	A
MAKING MEMORIES	538070490	0.0 ft	0°M	0.0 mph	Lost	A
REEF CHIEF	367116160	0.0 ft	0°M	19.2 mph	Lost	B
REEF CHIEF	310525000	0.0 ft	0°M	117.7 mph	Lost	A
STEPHEN DANN	369560000	0.0 ft	0°M	102.7 mph	Lost	A
TUCHKOV BRIDGE	636011644	0.0 ft	0°M	49.2 mph	Lost	A

selected target summary

Vessel: Search and rescue | Position: N 25°35.833' | Heading: 41° | Destination: MIAMI
Call sign: | W 80°15.500' | Length: 0.0 ft | ETA: |
IMO: N/A | CPA: 0.0 ft | Beam: 0.0 ft | Time: 2:50:02 PM
COG: 0° | TCPA: ---- | Draught: 0.0 ft | Date: 12/19/2012

AIS Target Key

Type: Unknown, Tug/Pilot, Yachts, Tankers, Passenger, Fishing, Cargo, High-Speed
Status: Dangerous, Uncertain, Sleeping, Inactive, Active, Lost, Anchor

Sort the AIS List

1. Press the EXIT key to select the sort bar. Tap a column name, or move the Joystick and press it on a column name. The first tap/Joystick press will sort the column low to high or A to Z. The second tap/Joystick press will sort it high to low or Z to A.

Display the AIS Data for a Selected Target (Targets Tool)

1. From the Home screen, select the Targets tool.
2. Under Lists, select AIS.
3. Tap a target or use the Joystick to select it. Review the summary information in the dialog box [see the illustration *AIS Target Data Received*].

Display the AIS Data for a Selected Target (Chart View or Radar View)

1. With a Chart View or Radar View displayed on-screen, tap a target to select it. Tap the target name.

OR

Use the Joystick to move the cursor to a target. Press the ENTER key.

2. The dialog box will display the target class, type, SOG [Speed over Ground], COG [Course over Ground], CPA [Closest Point of Approach], and TCPA [Time to Closest Point of Approach].

To see all information for the selected target, select Full Info.

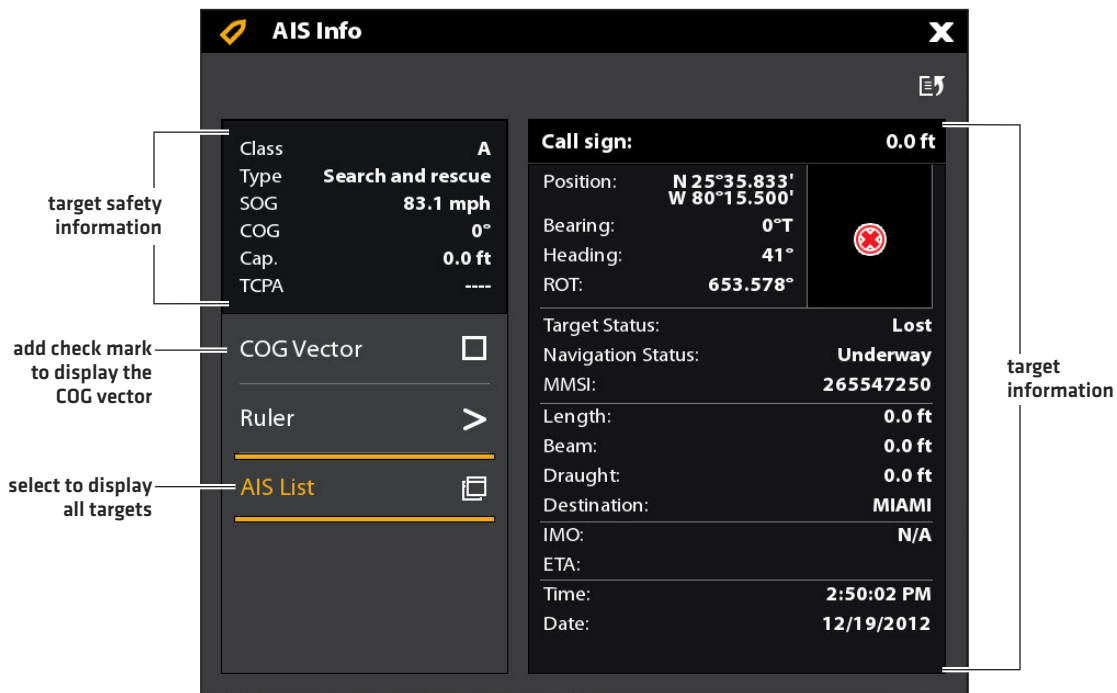

Display the COG Vector for a Selected Target





The COG Vector displays a line extending from the target that indicates the last known ship speed. COG indicates Course over Ground.

1. Select a target from the Targets tool, Radar View, or Chart View.
2. Tap the target name, or press the ENTER key.
3. Select COG Vector.
4. Tap the check box, or press the Joystick, to add a check mark to COG Vector.

MARPA TARGETS

Use MARPA to track targets on the Radar View. A compass/heading sensor must be attached to the control head network to enable MARPA, and the radar must be transmitting [see **Radar Overview**]. If an AIS is connected, then AIS targets will also be displayed on the Radar View. See **AIS and MARPA** for more information.

The control head tracks up to 20 targets at one time. Each target is assigned a number [1 to 20] and an icon to represent its safety status. The possible target status is as follows:

Icon	Status	Description
	Acquiring	The control head is processing the target data. The target has been identified but not yet tracked.
	Dangerous	The target is being tracked and has entered the Safe Zone or the Guard Zone.
	Lost	The target is not available for tracking. A target may be lost if it has not been scanned in the last 30 seconds. The target will be displayed with its last available position on the view.
	Safe	The target is being tracked and has not crossed the Safe Zone or Guard Zone.

Turn on MARPA Tracking

The radar must be transmitting so you can track targets. MARPA targets can be tracked in the Radar View or Chart View.



NOTE: The Radar Transmission Range also influences the number of acquired targets. If the Transmission Range is set too low, you may lose some target information. See **Radar Overview** for more information.

Track a Target

1. Press and hold a radar return. Select Track MARPA to acquire the target.

OR

Use the Joystick to move the cursor to a radar return. Press the Joystick to acquire the target.

Radar View with MARPA Targets Displayed

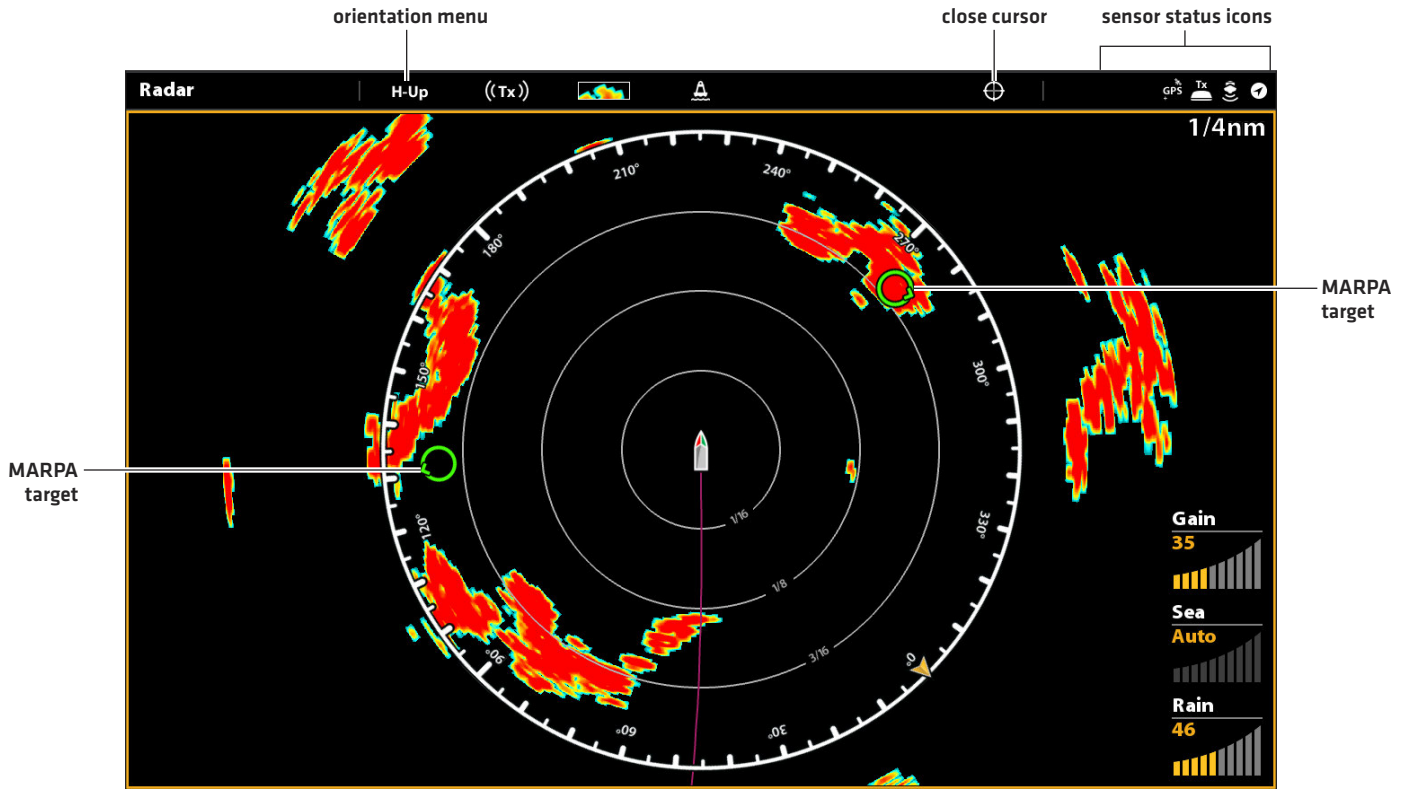

Press and Hold
a Radar Return

OR

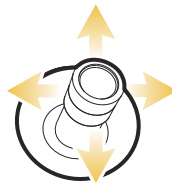

Move the Cursor to
a Radar Return

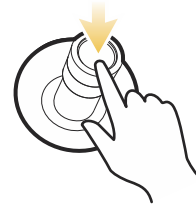

Press the Joystick
to Acquire Target

Cancel Tracking for a Selected Target

1. Select a target from the Radar View, Chart View, or Targets tool.
2. Tap the target name, or press the ENTER key.
3. Select Cancel Target.

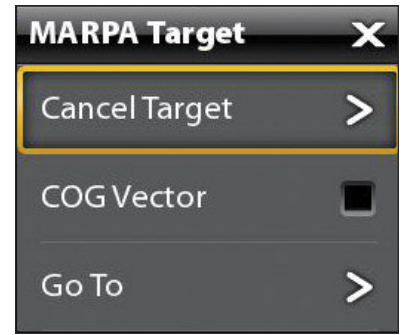

Cancel Tracking for all Targets (X-Press Menu)

Use the instructions in this section to cancel tracking from the X-Press Menu.

1. With a Chart View or Radar View displayed on-screen, tap Chart or Radar in the status bar. Select Info.

OR

Press the ENTER key.

2. Select MARPA: All Inactive.

Cancel Tracking for all Targets (Targets Tool)

Use the instructions in this section to cancel tracking from the Targets tool.

1. Press the HOME key.
2. Select the Targets tool.
3. Select Cancel All MARPA Targets.

Start Navigation to a Selected Target

Start navigation to a selected target using the following instructions. See *Introduction to Navigation* for more features and information.

Start Navigation to a Selected Target

Touch Screen

1. With a Chart View or Radar View displayed on-screen, tap a target to select it.
2. Tap Radar or Chart in the status bar, and select Go To.
3. Select Go To Cursor.

Keypad

1. With a Chart View or Radar View displayed on-screen, use the Joystick to move the cursor to a target.
2. Press the GO TO key.
3. Select Go To Cursor.



NOTE: You can also start navigation from the MARPA List in the Targets tool. Select a target and press the MENU key, or press and hold the target name. Select Go To.

Open the MARPA Target List

Open the MARPA List from the Targets Tool

1. Press the HOME key.
2. Select the Targets tool.
3. Under Lists, select MARPA.

Open the MARPA List from a View

1. With a Chart View or Radar View displayed on-screen, tap Chart or Radar in the status bar. Select Info.

OR

Press the ENTER key.

2. Select MARPA List.

MARPA Targets Data Received

The screenshot displays the MARPA List interface. At the top, it shows 'Radar' and 'H-Up' status. The main area is a table titled 'MARPA List' with columns: ID, Distance, CPA, TCPA, Brg, COG, SOG, and Status. The table contains two rows of data. A red circle highlights the first row, labeled 'selected target'. A line points to the column headers, labeled 'sort list by columns'. Another line points to the table area, labeled 'target list'. Below the table is a 'MARPA Target Key' with icons for Acquiring, Dangerous, Lost, and Safe. On the right side, there are radar controls for Gain (35), Sea (Auto), and Rain (46). The top right corner shows '1/4nm' and various system icons.

ID	Distance	CPA	TCPA	Brg	COG	SOG	Status
1	412.6 ft	145.9 ft	5 min	51°T	314.9°	0.4 mph	Dangerous
2	441.8 ft	441.8 ft	---	257°T	180°	0.0 mph	Lost

Sort the MARPA List

1. Press the EXIT key to select the sort bar. Tap a column name, or move the Joystick and press it on a column name. The first tap/Joystick press will sort the column low to high or A to Z. The second tap/Joystick press will sort it high to low or Z to A.

Display the MARPA Data for a Selected Target

1. With a Chart View or Radar View displayed on-screen, tap the target. Tap the target name.

OR

Use the Joystick to select a target. Press the ENTER key.

The dialog box will display the ID, SOG [Speed over Ground], COG [Course over Ground], CPA [Closest Point of Approach], and TCPA [Time to Closest Point of Approach].

Displaying MARPA Data for the Selected Target

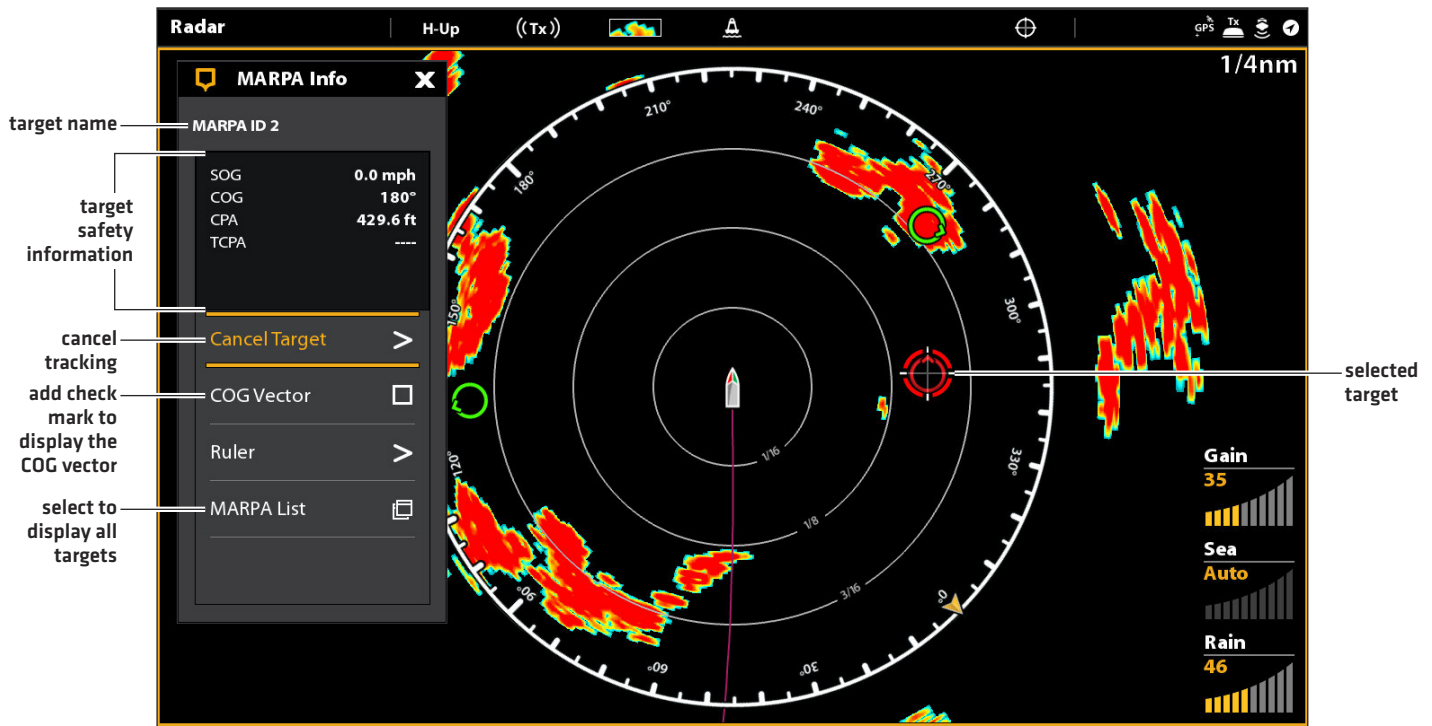

Display the COG Vector for a Selected Target

The COG Vector displays a line extending from the target that indicates the Course over Ground.

1. Select a target from the Radar View, Chart View, or Targets tool.
2. Tap the target name, or press the ENTER key.
3. Select COG Vector.
4. Tap the check box, or use the Joystick, to add a check mark to COG Vector.

SONAR OVERVIEW

A functioning transducer must be attached to the control head or selected as the transducer source on the Ethernet network to enable sonar functions. To purchase transducers and black box sonar equipment, visit our Web site at humminbird.com.

The SOLIX control head supports digital CHIRP sonar. Digital CHIRP sonar (2D CHIRP, Side Imaging CHIRP, and Down Imaging CHIRP) allows you to use multiple frequency ranges, either individually or blended together. Analog sonar (2D DualBeam PLUS, Side Imaging, and Down Imaging) uses single frequency ranges. To use single frequency sonar, turn CHIRP off. See [*Installation Information: Set up or Change Transducer Settings*].

 **NOTE:** Depth capability is affected by such factors as boat speed, wave action, bottom hardness, water conditions, and transducer installation. See the **Specifications** section for details.

2D CHIRP Sonar (XNT 14 20 T)

2D CHIRP sonar beams provide conical coverage directly below the boat for depths up to 1500 feet (500 m). CHIRP sonar sends continuous sonar pulses at varying frequencies to provide more detailed returns and better target separation. 2D CHIRP sonar returns are displayed on the traditional (2D) Sonar Views. The beams can be blended together, viewed separately, or compared side-by-side.

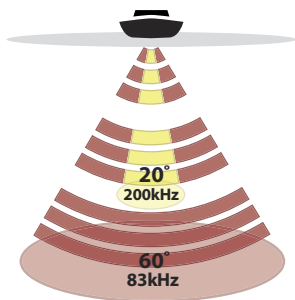

 60 Degree Total Coverage

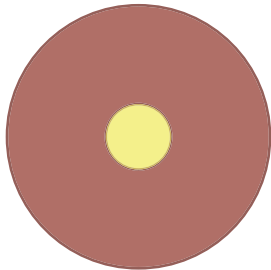

The transducer has a narrowly focused 20° center beam, surrounded by a second beam of 60°, expanding your coverage to an area equal to your depth. In 20 feet of water, the wider beam covers an area 20 feet wide.

The CHIRP sonar beams can be operated at one of three display frequencies: Medium, High, Medium/High (see *Installation Information: Set up or Change Transducer Settings*).

CHIRP MEGA Side Imaging Sonar (XM 14 20 MSI T)

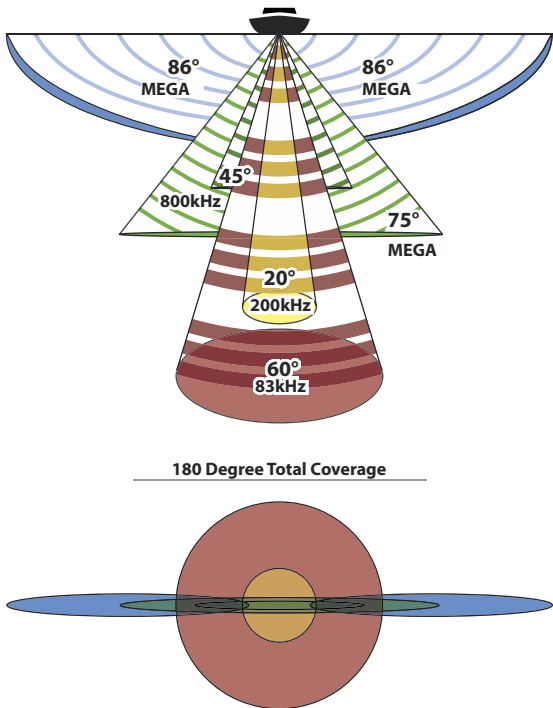

CHIRP MEGA Side Imaging sonar provides Side Imaging sonar, Down Imaging sonar, and DualBeam PLUS sonar on the control head.

Side Imaging sonar [shown in blue] uses two very precise sonar beams that are aimed at right angles to the path of the boat. The side beam coverage is very thin from front to back, yet very wide from top to bottom. The beams provide thin slices of the bottom for high resolution imaging.

The Side Imaging beams can be operated at one of three display frequencies: MEGA, 455 kHz, or 800 kHz. Select MEGA for the sharpest image with the highest resolution for up to approximately 250 feet side to side. Select 800 kHz as an alternative to the MEGA frequency, and select 455 kHz for greater bottom coverage at approximately 800 feet side to side.

The **Down Imaging** beams [shown in green] point down and scan the water with razor-thin, high definition beams. The beams are wide side to side, but very thin from front to back. The beams can be operated at one of three display frequencies: MEGA, 455 kHz, or 800 kHz. Select MEGA for the sharpest image with the highest resolution for up to approximately 125 feet. Select 800 kHz as an alternative to the MEGA frequency, and select 455 kHz for the best overall image quality and depth at 400 ft.

The **DualBeam PLUS** sonar beams [shown in magenta and yellow] provide conical coverage directly below the boat. DualBeamPLUS sonar returns are displayed on the Sonar [2D] Views. The beams can be blended together, viewed separately, or compared side-by-side.

CHIRP sonar allows you to operate the beams at different frequency ranges [see **Installation Information: Set up or Change Transducer Settings**]. CHIRP sonar sends continuous sonar pulses at varying frequencies to provide more detailed returns and better target separation.

SONAR SETUP

The available sonar views and menus on the control head are determined by the connected transducer and the selected transducer source. The selected transducer must be pinging to enable the views.

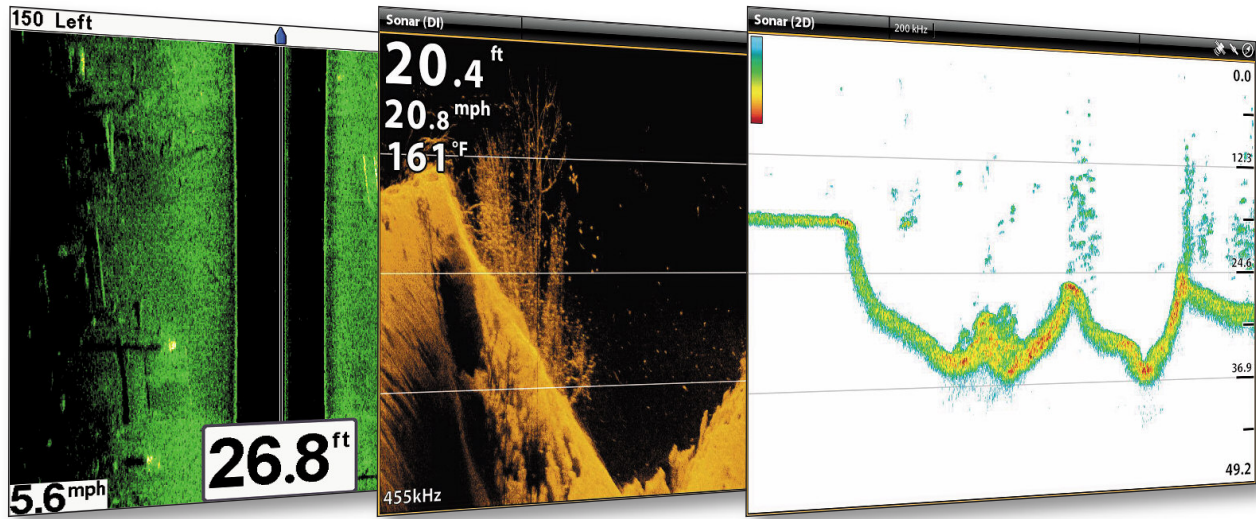

When you connect a transducer to a black box sonar or to the SOLIX control head, the transducer will be detected in the network automatically. The best sonar source will be chosen and start pinging automatically.

To manually select a sonar source, see *Installation Information: Set up your Humminbird Network*.

Transducer Settings: To review transducer settings, including sonar frequencies, depth offset, and maximum depth, see *Installation Information: Set up or Change Transducer Settings*. Also, visit our Web site at humminbird.com to download the Transducer Setup Guide and review troubleshooting options.

Sonar Settings: You can also change the water type, adjust the noise filter, and select transducer beams. The main sonar settings are displayed in the Sonar tab in the Settings tool [Home > Settings > Sonar]. If an accessory transducer is added to the configuration [such as a 360 Imaging transducer or an Airmar CHIRP transducer], the related menu options will be added to the menu system. See *Installation Information: Set up or Change Transducer Settings*.



NOTE: Visit our Web site at humminbird.com for the latest compatible transducers and accessories for your control head.

SONAR ALARMS

Before you start navigating and fishing with your control head, set up sonar alarms. A functioning transducer must be attached to the control head or selected as the transducer source on the network to enable all sonar functions.

Turn on Sonar Alarms

1. Press the HOME key.
2. Select Alarms.
3. Select Alarms > Sonar.
4. Select an alarm and turn it on. Tap the on/off button, or press the ENTER key, to turn it on.
5. Press and hold the slider, or press and hold the ENTER key, to adjust the range setting.

Fish [Shallow]	Turn on Fish [Shallow] to receive an alarm if fish are detected in shallow water. You can also adjust the shallow water range with the slider.
Fish [Deep]	Turn on Fish [Deep] to receive an alarm if fish are detected in deep water. You can also adjust the deep water range with the slider.
Shallow Water	If the bottom depth is less than the amount you set, the control head will provide an alarm.
Deep Water	If the bottom depth is more than the amount you set, the control head will provide an alarm.

2D SONAR OVERVIEW

(DUALBEAM PLUS TRANSDUCER REQUIRED)

As the boat moves, the unit charts the changes in depth on the display to create a profile of the bottom contour. The 2D Sonar View displays the sonar return intensity with different colors.

Strong returns often result from rocky or hard bottoms (compacted sediment, rocks, fallen trees), while weaker returns often result from soft bottoms (sand, mud), vegetation, and small fish.

The colors used to represent high, medium, to low intensity returns are determined by the palette you choose in the Preferences menu (see *Open the 2D Sonar Preferences Menu: Change the Palette and Background*).

The control head displays the return intensity based on the Palette and Bottom View menu settings. You can display the RTS Window (Real Time Sonar), turn on/off fish symbols (Fish ID+), change the SwitchFire mode, adjust sensitivity, and more.

2D Sonar View: Original Palette

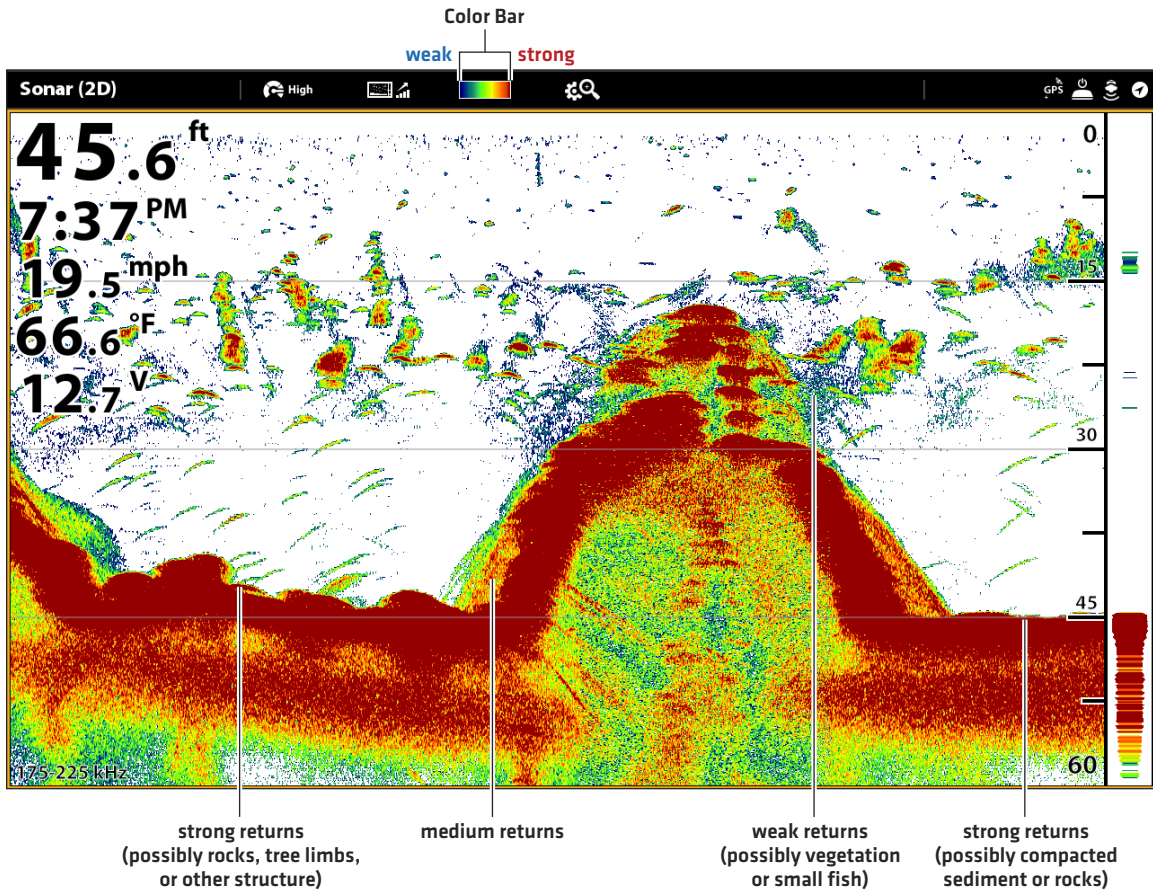

← Sonar History – Historical returns scroll left across the view.



Drag to see History

OR

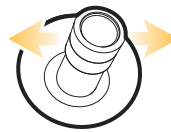

Move to see History

CUSTOMIZE THE 2D SONAR VIEW

The settings in this section are optional. You can use the default settings for the 2D Sonar View, or you can customize it with your preferences. See **Views** for more information.

OPEN THE 2D SONAR PREFERENCES MENU

The Preferences menu allows you to set the sonar mode, zoom mode, return palette, background color, bottom view, and RTS Window. For more information about view preferences, see **Views**.

1. With a 2D Sonar View displayed on-screen, tap Sonar [2D] in the status bar, or press the MENU key once.
2. Select Sonar Options.
3. Select Preferences.

Change the Sonar Mode

The 2D Sonar data can be displayed on the full screen. You can also choose a split screen to display the beams separately, or you can display a split zoom view.

1. From the Preferences menu, select Sonar Mode.
2. Select a mode to apply to the view.

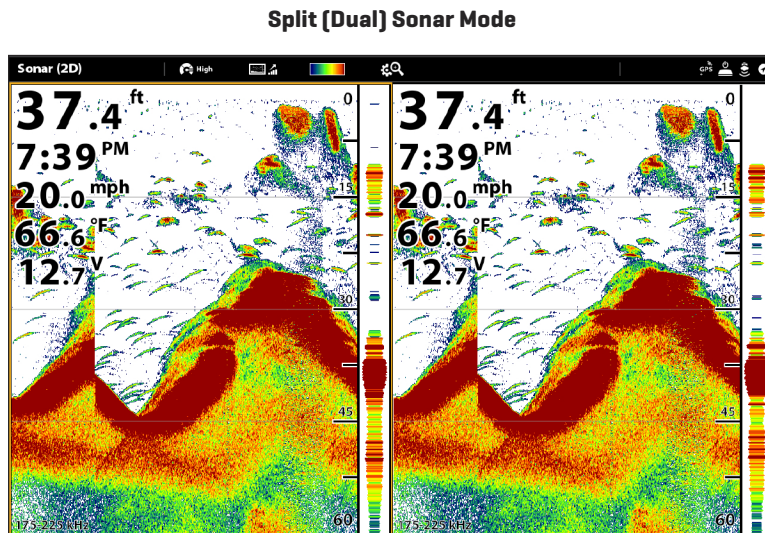

Normal	The 2D Sonar is displayed on the full screen.
Split [Zoom]	The view is split into two sides. 2D Sonar View is displayed on the right side with a zoom preview box. The zoomed view is shown on the left side. Select Split [Zoom] from the Preferences menu, and you can turn on Flat Bottom and change the Zoom Window size.
Split [Dual]	The view displays sonar returns from each down beam frequency on separate sides of the screen. You can use the split mode to make side by side comparisons between the sonar returns from both beams.

Set the Zoom Mode

The Zoom Mode sets the zoom commands to magnify the full pane or the cursor selection. See *Use Cursor and Zoom in Sonar Views* to apply the zoom features.

1. From the Preferences menu, select Zoom Mode.
2. Select Pane Zoom or Cursor Zoom.

Pane Zoom	When you use pinch out/in [touch screen] to zoom, or press the +/- ZOOM keys, the view will be magnified.
Cursor Zoom	When you use pinch out/in [touch screen] to zoom, or press the +/- ZOOM keys, the cursor selection will be magnified.

Change the Color Palette

The Sonar Colors menu changes the colors used to display sonar returns on the view.

1. From the Preferences menu, select Sonar Colors.
2. Select a color palette.



QUICK TIP! This setting can also be changed in the status bar menu

Sonar View with a Customized Palette and Background

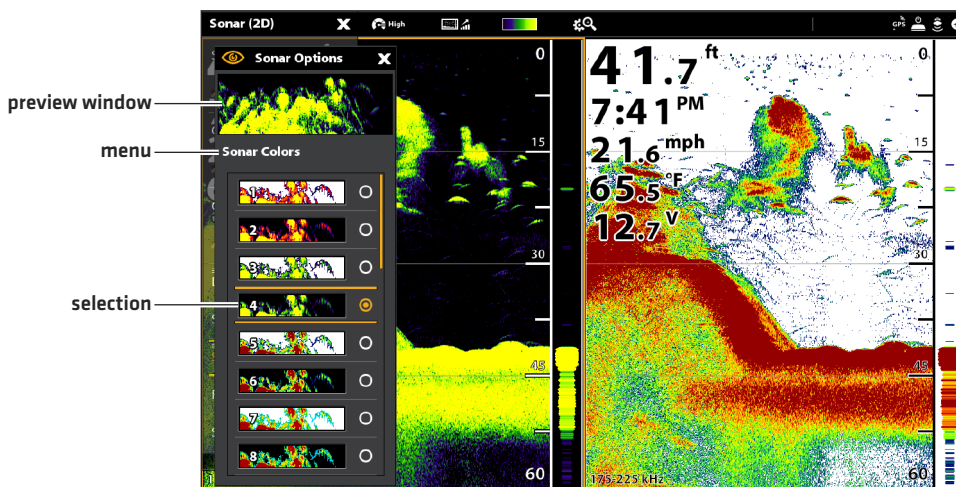

Palette Options

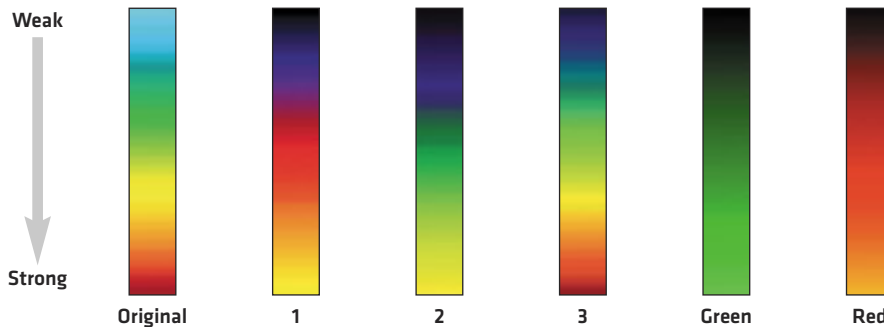

Set the Bottom View Preferences

Bottom View selects the method used to represent bottom and structure on the display. There are many ways to display the bottom on the display.

1. From the Preferences menu, select Bottom View.
2. Select Structure ID or White Line. Then, select Bottom Fill and/or Bottom Line to add them to the view.

2D View with Bottom View Options Displayed

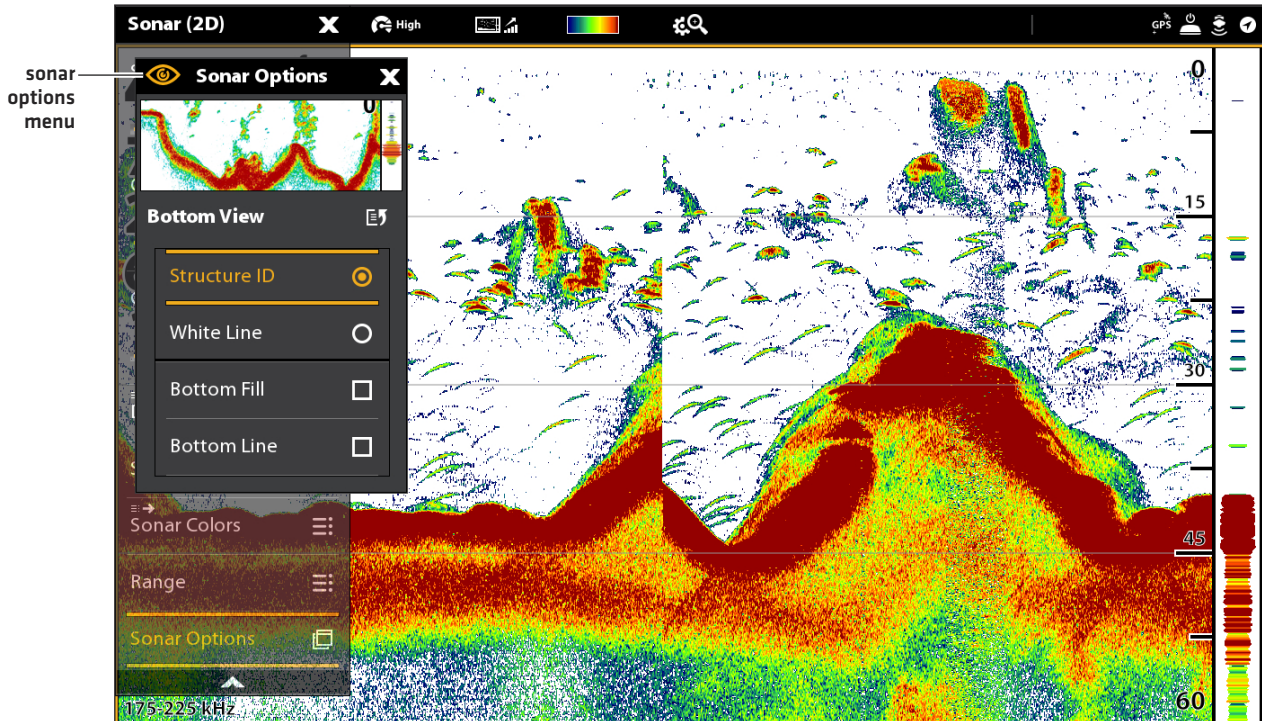

Structure ID	Structure ID represents weak returns in blue and strong returns in red (original palette). If the Palette is changed, the Structure ID will display the strongest return as specified by the palette.
White Line	White Line highlights the strongest sonar returns in white. This has the benefit of clearly defining the bottom on the display.
Bottom Fill	Select Bottom Fill to see the shaded bottom filled in with a solid color on the view. This has the benefit of clearly defining the bottom location on the display.
Bottom Line	Select Bottom Line to display the depth reading from the Depth Source as a line, either from the selected transducer or another digital depth source. See Set up your Humminbird Network for details about selecting sources.

Display the RTS Window

The RTS Window plots the depth and intensity of a sonar return. It updates at the fastest rate possible for depth conditions and shows only the returns from the bottom, structure, and fish that are within the transducer beam. When you use the cursor to review sonar history, the sonar history will pause, but the RTS Window will continue to display sonar returns in real time.

1. From the Preferences menu, select RTS Window.
2. Tap the on/off button, or press the ENTER key, to turn it on. Then, choose the type of RTS Window to display.

Color [A-Scope]	Sonar returns are displayed in color. The size of the displayed lines correspond with the intensity of the sonar returns from the transducer beam[s].
Color [Full]	Sonar returns are displayed in color, and they fill the width of the RTS Window.
Mono	Sonar returns are displayed in black.

Turn on/off Fish ID+

Fish ID+ uses advanced signal processing to interpret sonar returns. When Fish ID+ is selected, fish symbols will be displayed on the Sonar View when very selective requirements are met.

When Fish ID+ is not selected, the control head shows only the raw sonar returns on the display. The returns appear as arches on the display to indicate potential targets.

1. From the Preferences menu, select Fish ID+.
2. Use the following menu options to display fish icons, adjust the sensitivity, and more.

Fish Icons	Select Fish Icons to display fish symbols on the 2D Sonar View when a fish is detected. Blue Fish Icons = targets detected in the 200 kHz narrow beam. Orange Fish Icons = targets detected in the 83 kHz or 50 kHz wide beam.
Fish Depth	The depth of the fish is displayed above the fish icon.
ID Sensitivity	Use ID Sensitivity to adjust the threshold used for detecting a fish with Fish ID+. [1 = low sensitivity, where only a large fish will be displayed, and 10 = high sensitivity, where small fish up to large fish will be displayed]
Fish Alerts	To receive an on-screen alert when a fish is detected, turn on this menu option.

2D Sonar View (Split Dual Mode) with RTS Window and Fish ID+ Turned On

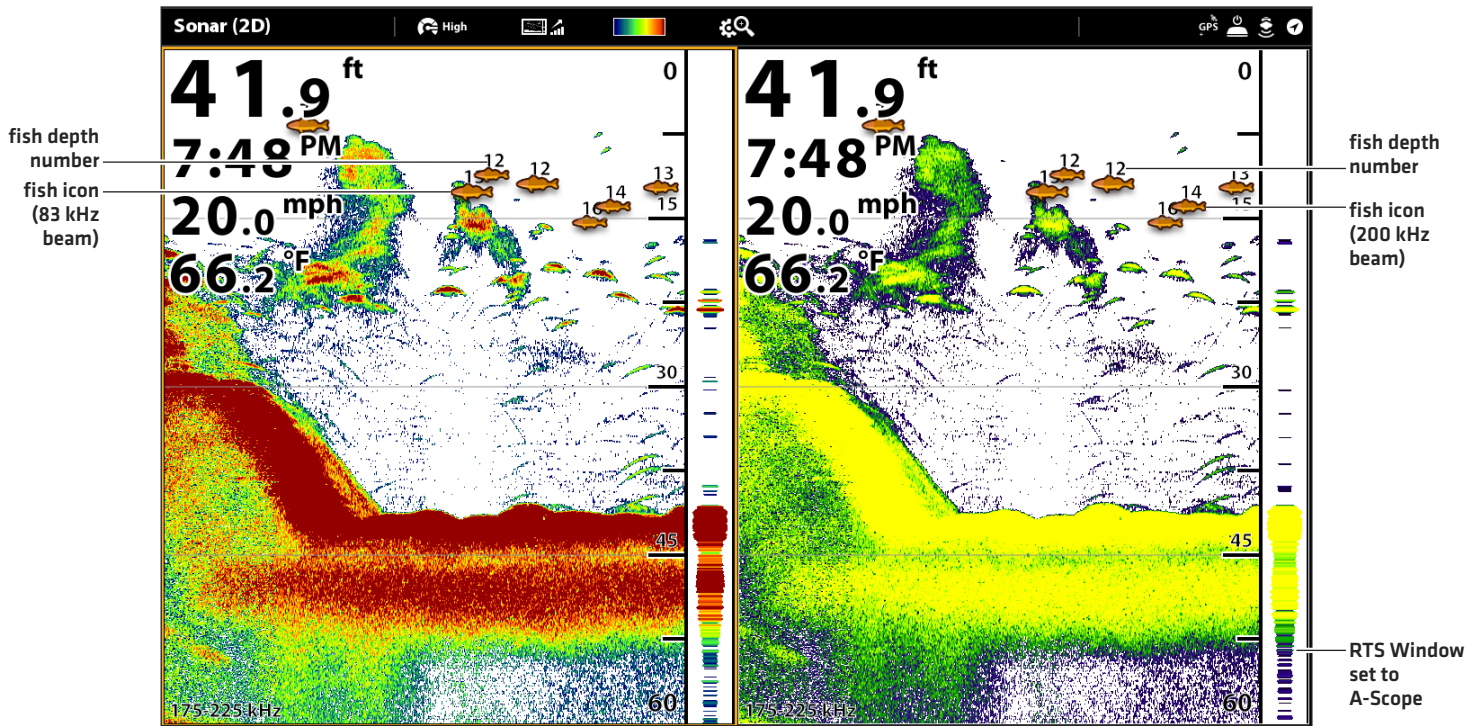

CHANGE THE 2D SONAR VIEW OVERLAYS

Use the Overlays menu to display or hide information on the view. In the 2D Sonar View, you can display the following: depth lines, depth range, a color bar for the selected palette, temperature graph, beam frequency label, and data overlays. Digital readout data can be displayed as an overlay, and it can be displayed in the data bar. To turn on the data bar, see **Views: Display a Data Bar**. For more information about data overlays, see **Views**.

1. With a 2D Sonar View displayed on-screen, tap Sonar [2D] in the status bar, or press the MENU key once.
2. Select Sonar Options.
3. Select Overlays.
4. Tap the menu, or use the Joystick to select an item, and add a check mark. [check mark = visible, blank = hidden].

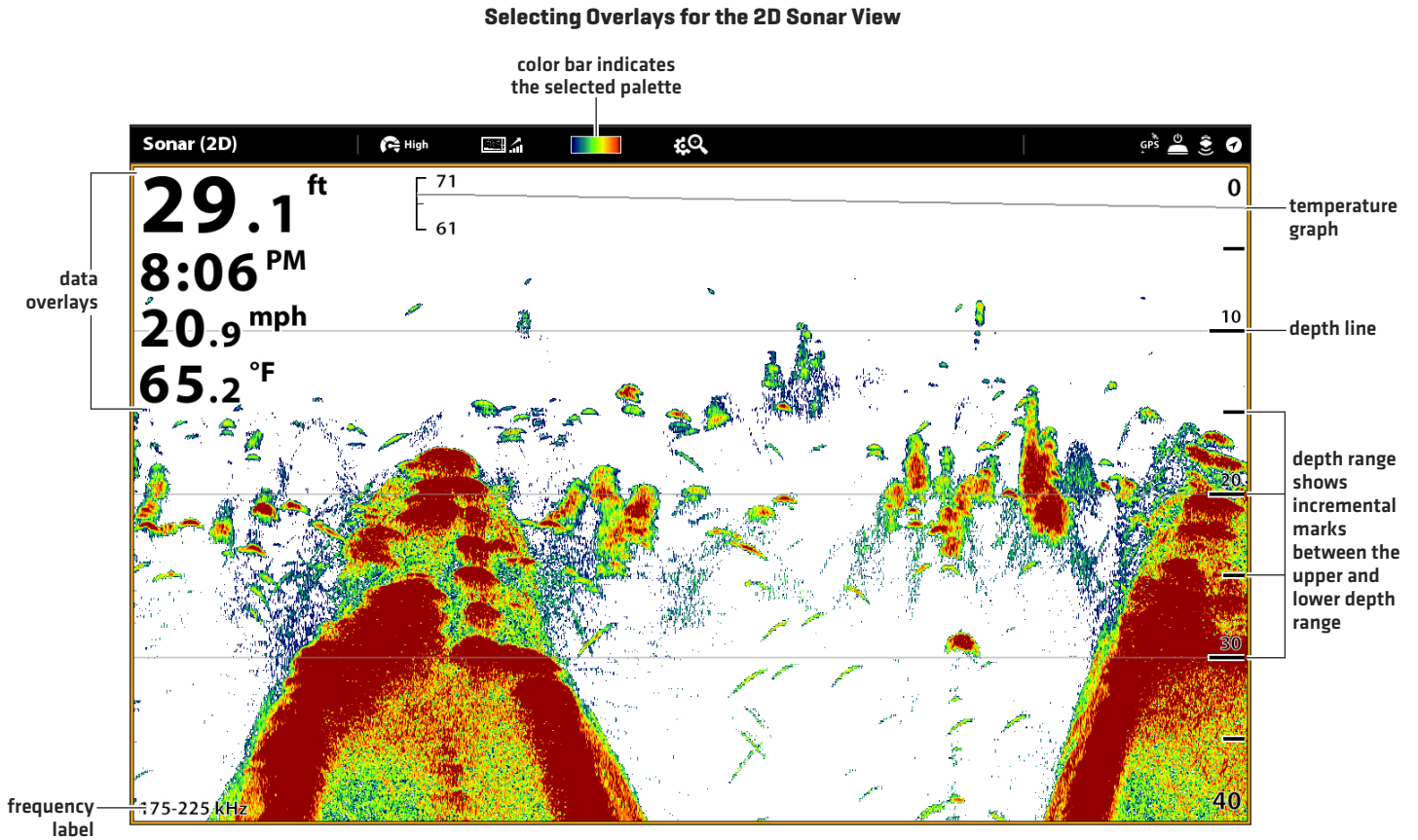

ADJUST 2D SONAR DISPLAY SETTINGS

The X-Press Menu provides menu options to adjust the sensitivity and range as you fish. You can also mark a particular depth and control how fast the sonar history scrolls across the screen. The menu options allow you to see more or less of the sonar returns from the transducer beams as you adjust each setting.

Adjusting Sonar Display Settings

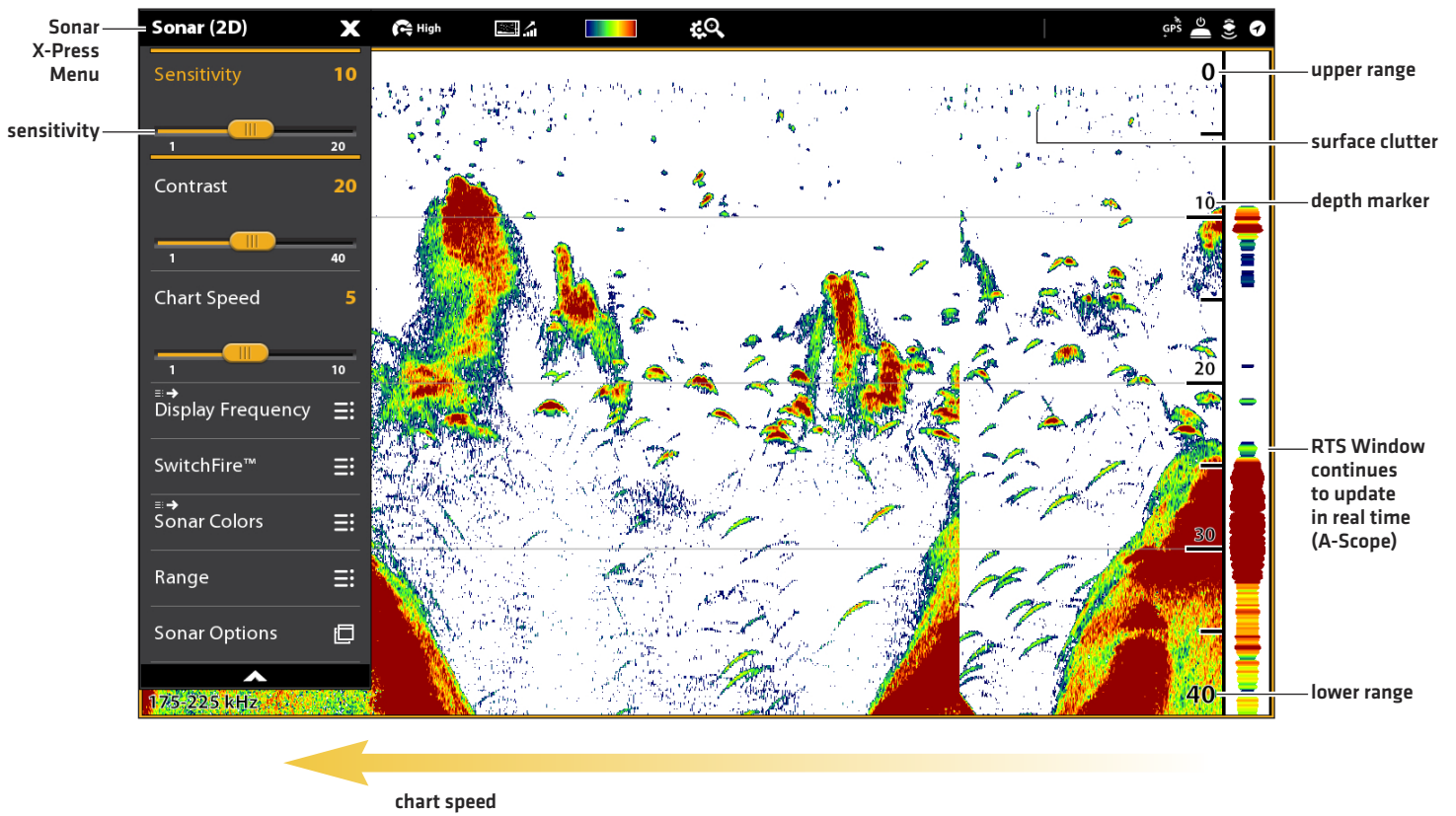

Adjust Display Settings

1. With a 2D Sonar View displayed on-screen, tap Sonar [2D] in the status bar, or press the MENU key once.
2. Select Sensitivity, Contrast, or Chart Speed.
3. Press and hold the slider, or turn the Rotary dial, to adjust the setting.

Sensitivity	Sensitivity controls how much detail is shown on the display and will adjust the sensitivity of all sonar frequencies. Decrease the sensitivity to eliminate the clutter from the display that is sometimes present in murky or muddy water. When operating in very clear water or greater depths, increase the sensitivity to see weaker returns that may be of interest. QUICK TIP! This setting can also be changed by turning the Rotary dial.
Contrast	Contrast allows you to choose a range of the Sonar Colors palette to display sonar returns. When Contrast is set to 20 (default), the entire Sonar Colors palette (represented by the Color Bar) is used to display weak and strong sonar returns. As you increase the Contrast, the top range of the Color Bar is used to display all sonar returns (whether weak or strong). As you decrease the Contrast, the bottom range of the Color Bar is used to display all sonar returns (whether weak or strong).
Chart Speed	Chart Speed determines how fast the sonar history moves across the display and how much detail is shown. Select a faster speed to see more detail. Select a slower speed to keep the sonar history on the display longer.

Filter Surface Clutter

Use Surface Clutter to reduce the noise that may appear at the top of the view caused by algae and aeration. The lower the setting, the less surface clutter will be displayed. A higher setting allows more surface clutter to be displayed.

1. With a 2D Sonar View displayed on-screen, tap Sonar [2D] in the status bar, or press the MENU key once.
2. Select Sonar Options > Surface Clutter.
3. Press and hold the slider, or turn the Rotary dial, to adjust the setting.

Change the SwitchFire Mode

SwitchFire controls how the sonar returns are displayed in the view.

1. With a 2D Sonar View displayed on-screen, tap Sonar [2D] in the status bar, or press the MENU key once.
2. Select SwitchFire.
3. Select Clear Mode or Max Mode.

SwitchFire: Clear Mode

Tap to open the SwitchFire menu in the status bar.

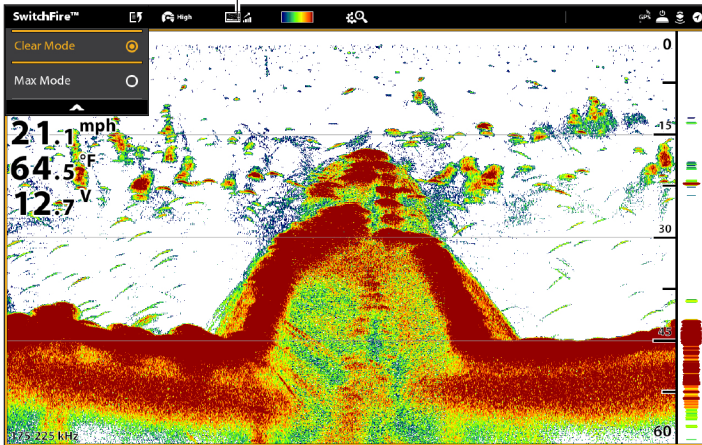

Choose Clear Mode to see less clutter and more fish size accuracy on the display. When Clear Mode is selected, the clutter is filtered, and sonar returns are interpreted to provide more details about the objects within the transducer beam, regardless of their location. In other words, a large arch on the display means a large fish has been detected.

SwitchFire: Max Mode

Tap to open the SwitchFire menu in the status bar.

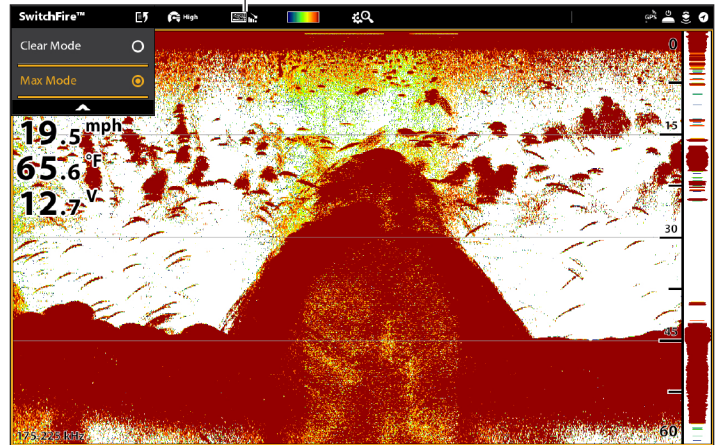

Choose Max Mode to see only raw sonar returns on the display. When Max Mode is selected, you will see the maximum sonar information available within the transducer beam, so more fish arches and better jig tracking are shown.



QUICK TIP! This setting can also be changed in the status bar menu. See the illustrations above.

Set the Range

Range controls how much of the water column is displayed on the view. For example, if you are only interested in the area between 20 and 50 feet deep, set the Upper Range to 20 and the Lower Range to 50. The view will not display sonar returns outside of the set ranges, and greater detail for the selected range will be displayed.

1. With a 2D Sonar View displayed on-screen, tap Sonar [2D] in the status bar, or press the MENU key once.
2. Select Range.
3. Select Upper Range. Press and hold the slider, or press and hold the ENTER key, to adjust the setting.
4. Select Lower Range.

Auto: Move the slider to Auto. The Lower Range will be adjusted by the control head to follow the bottom automatically.

Man [Manual]: Move the slider to Manual and adjust the setting.

Display the Depth Marker

To mark a specific depth on the view, turn on Depth Marker. This menu is available in Custom Mode [see *The Menu System: Change the User Mode*].

1. With a 2D Sonar View displayed on-screen, tap Sonar [2D] in the status bar, or press the MENU key once.
2. Select Sonar Options.
3. Select Depth Marker.
4. Tap the on/off button, or press the ENTER key, to turn it on.
5. Press and hold the slider, or press and hold the ENTER key, to adjust the setting.

Select Frequencies

If there are multiple beams available in a transducer, you can display individual frequencies on the 2D Sonar View. See *Installation Information: Set up your Humminbird Network, Select Sonar Sources* and *Set up or Change Transducer Settings* for details.

1. With a 2D Sonar View displayed on-screen, tap the frequency menu in the status bar.

OR

Press the MENU key. Select Sonar Options > Preferences > Display Frequency.

2. Select a frequency from the list.



NOTE: If the control head is using a sonar source with only one beam frequency, the frequency list will not offer additional options.



QUICK TIP! This setting can also be changed by pressing and holding the ENTER key.

2D Sonar View

Tap to open the SwitchFire menu in the status bar.

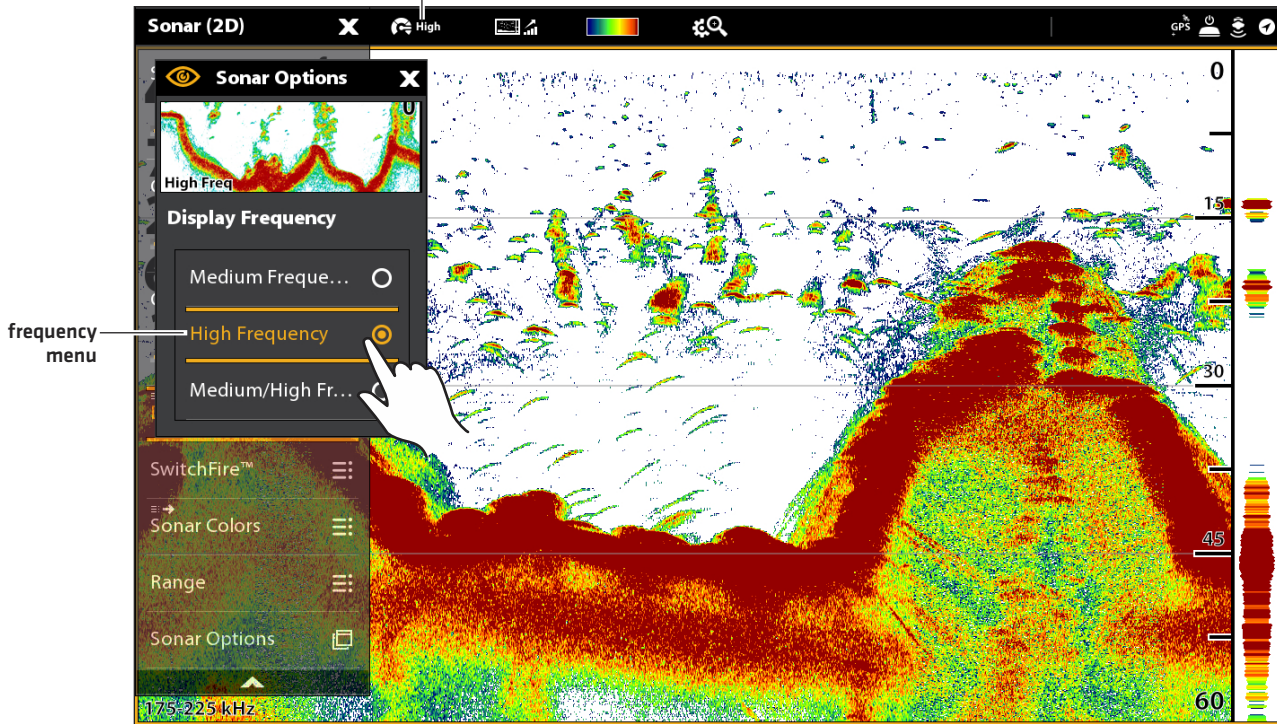

Tap to Select

OR



Press and Hold
to Change the Setting

Adjust Beam Sensitivity

Your control head model may allow you to adjust the sensitivity of individual frequencies. The available frequencies are determined by your control head model and the installed transducer. Use the following instructions to adjust a single beam.

1. With a 2D Sonar View displayed on-screen, tap Sonar [2D] in the status bar, or press the MENU key once.
2. Select Sonar Options.
3. Select Medium or High Sensitivity Offset.
4. Press and hold the slider, or turn the Rotary dial, to adjust the setting.

SIDE IMAGING OVERVIEW

(SIDE IMAGING TRANSDUCER REQUIRED)

Side Imaging beams “illuminate” the bottom contour, structure, and fish. The side beam coverage is very thin from front to back, yet very wide from top to bottom. The bottom composition determines the intensity of the sonar return, and upward slopes that face the transducer reflect sonar better than downward slopes that face away from the transducer.

Side Imaging View

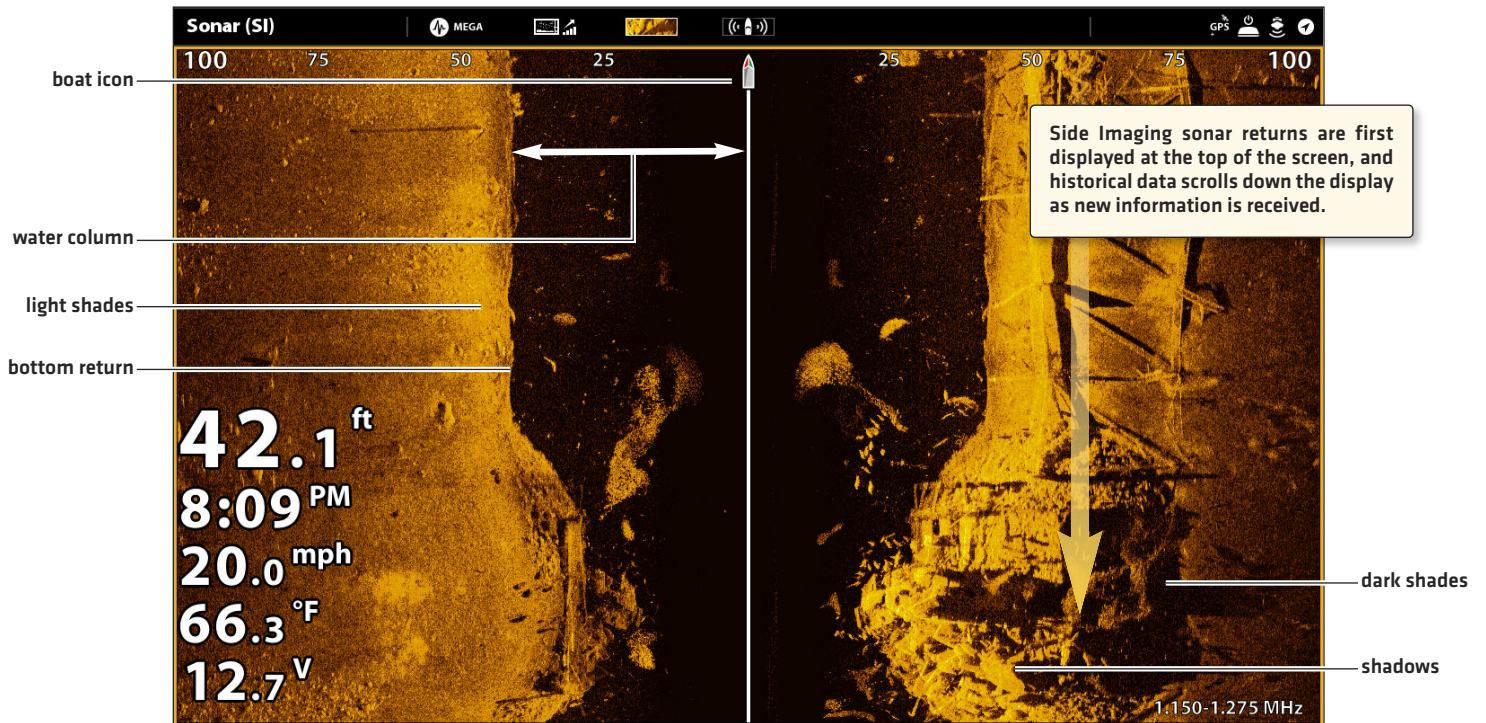

Use the light and dark parts of the display to interpret the objects on the view as follows:

Shadows: The longer the shadow, the taller the object. Fish also cast shadows, and their distance from the bottom can be interpreted by their shadow.

Light Shades represent denser terrain (possibly compacted sediment, timber, rocks) or rising terrain.

Water Column: shows the relative depth of the water under the vessel at any given time. Variations in the width of the water column show variations in the distance to the bottom as the vessel passes over. See the illustration *Interpreting the Side Imaging View*.

White Streaks or **Clouds** may represent fish on the display.

Dark Shades represent soft returns (possibly sand or mud) or descending terrain.

Interpreting the Side Imaging View

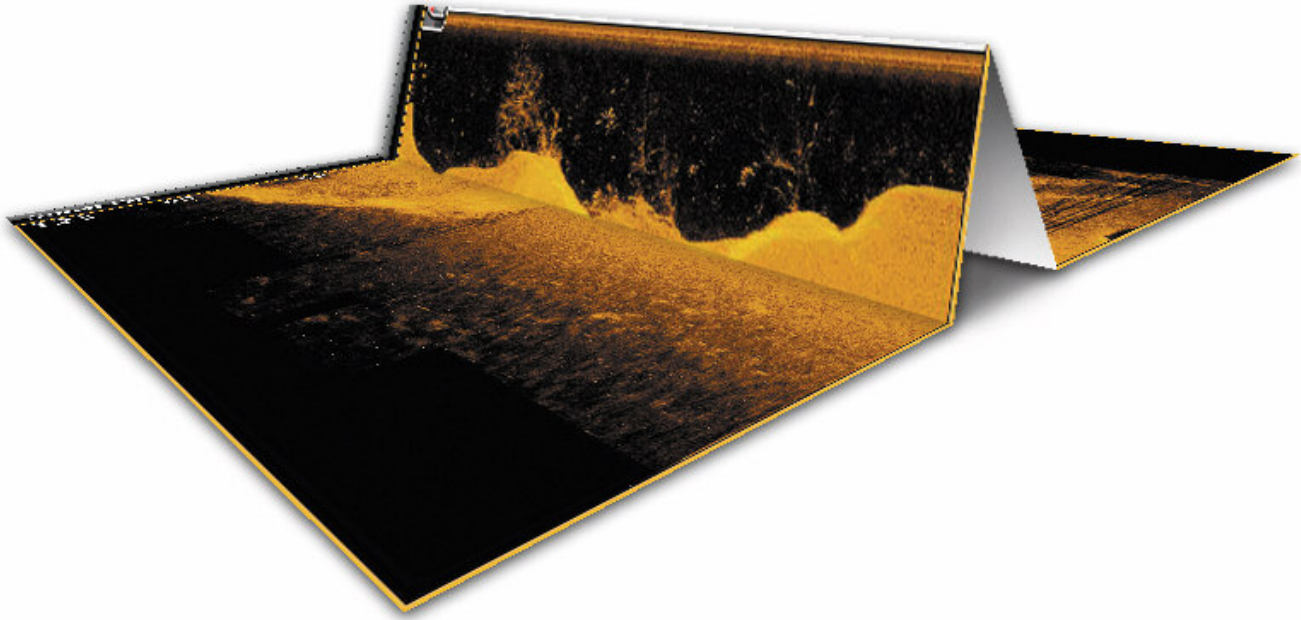

To visualize how Side Imaging works, the Side Imaging View illustration can be folded down the middle and then folded again at the lowest point of the water column. The raised area reveals the water column with its relative depth of the water under the vessel. In the Side Imaging View, variations in the width of the water column show variations in the distance to the bottom as the vessel passes over.

For Best Side Imaging Performance

- Vessel Speed: 2 to 6 mph
- Straight line navigation
- Minimum turning time and wave turbulence

Also, see humminbird.com for tutorials and Side Imaging videos.

CUSTOMIZE THE SIDE IMAGING VIEW

The settings in this section are optional. You can use the default settings for the view, or you can customize it with your preferences. See **Views** for more information.

OPEN THE SIDE IMAGING PREFERENCES MENU

The Preferences menu allows you to select a beam to display, set the zoom mode, return palette, and turn on Contour Mode and SI Navigation. For more information about view preferences, see **Views**.

1. With a Side Imaging View displayed on-screen, tap Sonar [SI] in the status bar, or press the MENU key once.
2. Select Sonar Options.
3. Select Preferences.

Select Beams to Display

The Side Imaging View displays both beams on the view. You can also choose to display the left side or the right side of the Side Imaging transducer beams.

1. From the Preferences menu, select SI Side.
2. Select a side to display.

Change the Color Palette

The Sonar Colors menu changes the colors used to display sonar returns on the view.

1. From the Preferences menu, select Sonar Colors.
2. Select a color palette.

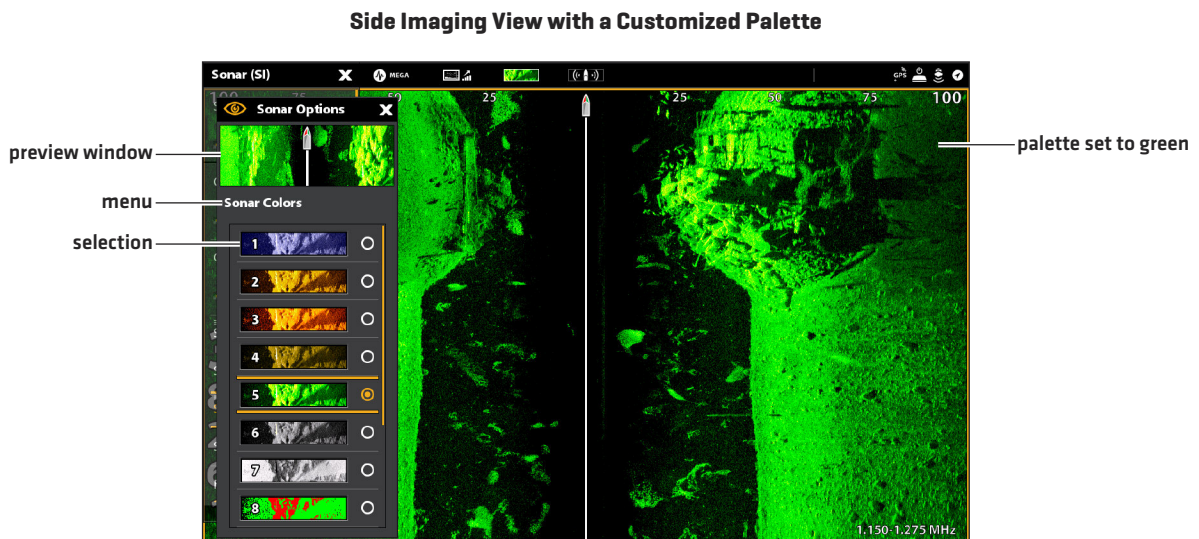

 **QUICK TIP!** This setting can also be changed in the status bar menu.

Turn on/off Contour Mode

Contour Mode controls how the water column is displayed in the Side Imaging Views. When Contour Mode turned off, the water column is displayed on the view. The location of a target on the display is based on the slant range to the target.

When Contour Mode is turned on, the bottom is graphed at a constant point on the display, regardless of changes in depth. The Side Imaging beams are divided by a vertical line. The water column is removed from the view, which allows the display to show targets at their linear horizontal distance. The location of a target may be easier to interpret when the water column is removed.

1. From the Preferences menu, select Contour Mode.
2. Tap the on/off button, or press the ENTER key, to turn it on/off.

Contour Mode Off

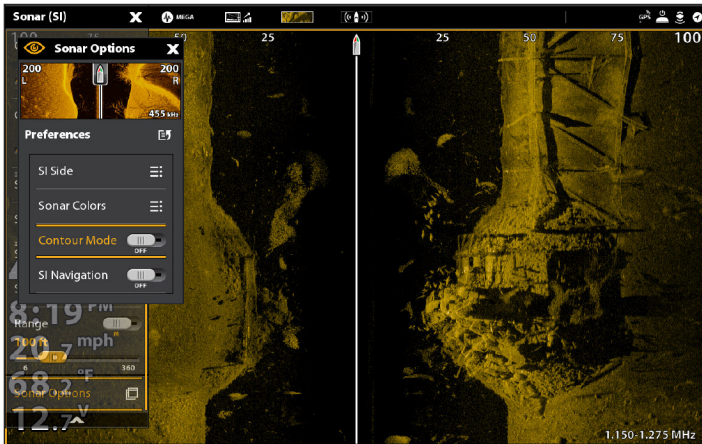

The water column is displayed on the Side Imaging View.

Contour Mode On

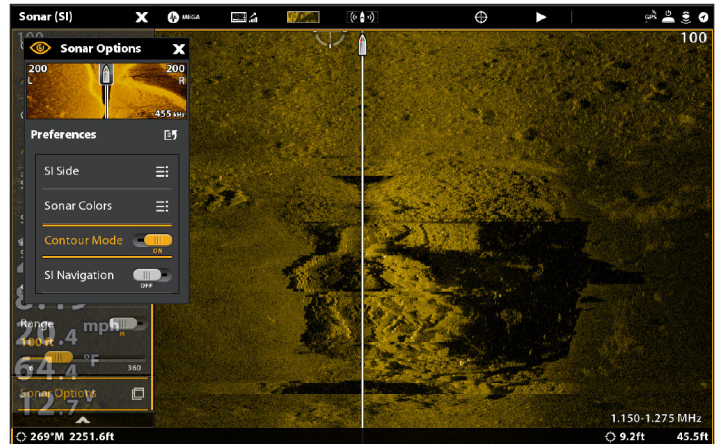

The water column is removed from the Side Imaging View.

Turn on/off SI Navigation

SI Navigation controls how the boat icon is displayed in Side Imaging Views. See *Navigation in Sonar Views* for more information. If SI Navigation is turned on, the boat icon indicates the direction the boat needs to turn to reach the next waypoint during navigation.

If SI Navigation is turned Off, the boat icon will not change during navigation although you can still mark waypoints and start navigation from a Side Imaging View.

1. From the Preferences menu, select SI Navigation.
2. Tap the on/off button, or press the ENTER key, to turn it on/off.

CHANGE THE SIDE IMAGING VIEW OVERLAYS

Use the Overlays menu to display or hide information on the view. In the Side Imaging View, you can display the following: boat icon, range lines, range intervals, side label, frequency label, and data overlays. To turn on the data bar, see **Views: Display a Data Bar**. For more information about data overlays, see **Views**.

1. With a Side Imaging View displayed on-screen, tap Sonar [SI] in the status bar, or press the MENU key once.
2. Select Sonar Options.
3. Select Overlays.
4. Tap the menu, or use the Joystick to select an item, and add a check mark. [check mark = visible, blank = hidden].

Selecting Overlays for the Side Imaging View

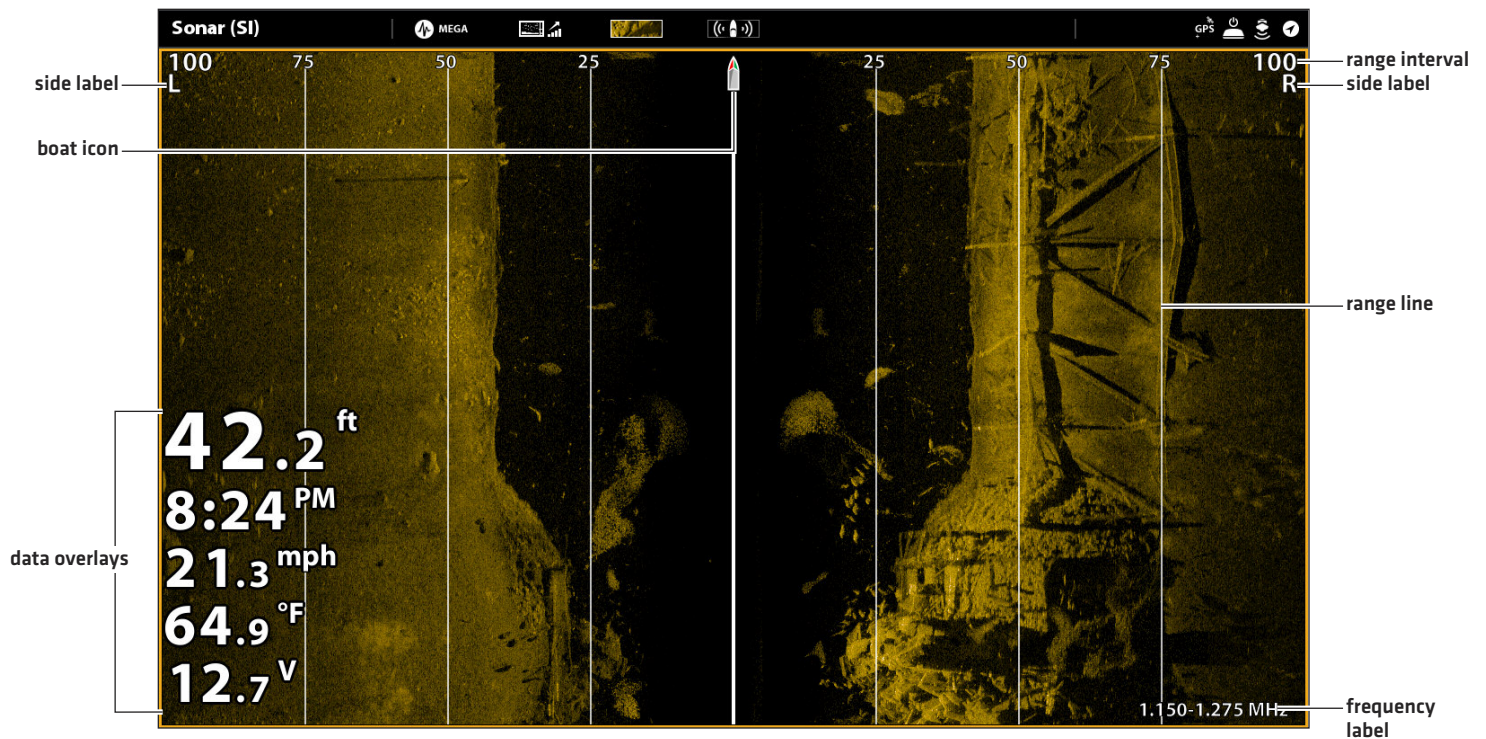

ADJUST SIDE IMAGING DISPLAY SETTINGS

The X-Press Menu provides menu options to adjust the sensitivity, contrast, sharpness, and range as you fish. You can also mark a particular range, and you can control how fast the sonar history scrolls across the screen. The menu options allow you to see more or less of the sonar returns from the transducer beams as you adjust each setting.

Adjust Display Settings

1. With a Side Imaging View displayed on-screen, tap Sonar [SI] in the status bar, or press the MENU key once.
2. Select Sensitivity, Contrast, Chart Speed, or Sharpness.
3. Press and hold the slider, or turn the Rotary dial, to adjust the setting.

Adjusting Side Imaging Display Settings

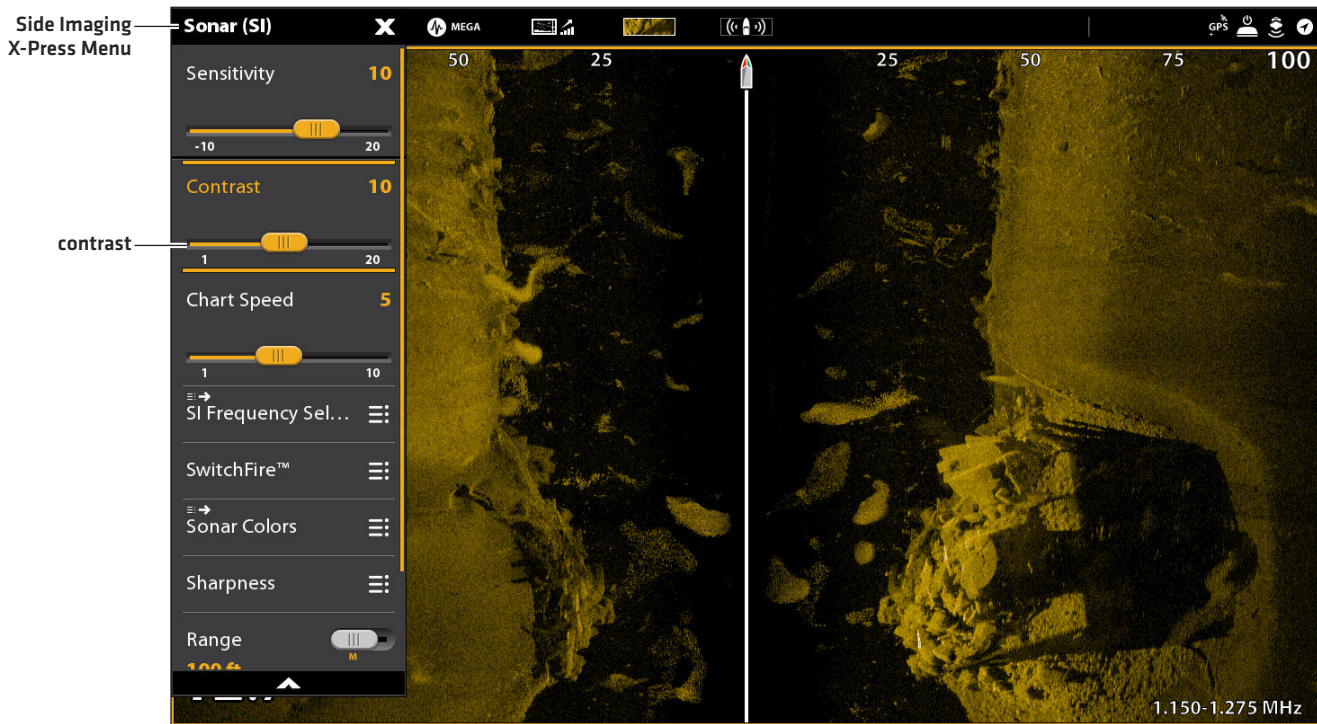

<p>Sensitivity</p>	<p>Sensitivity controls how much detail is shown on the display and will adjust the sensitivity of all sonar frequencies. Decrease the sensitivity to eliminate the clutter from the display that is sometimes present in murky or muddy water. When operating in very clear water or greater depths, increase the sensitivity to see weaker returns that may be of interest.</p> <p>QUICK TIP! This setting can also be changed by turning the Rotary dial.</p>
<p>Contrast</p>	<p>Adjust the Contrast setting to accent the light and dark parts of the Side Imaging data to provide greater definition.</p>
<p>Chart Speed</p>	<p>Chart Speed determines how fast the sonar history moves down the display and how much detail is shown. Select a faster speed to see more detail. Select a slower speed to keep the sonar history on the display longer.</p>
<p>Sharpness</p>	<p>Turn on Sharpness and select a filter level to sharpen the edges of the Side Imaging data.</p>

Change the SwitchFire Mode

SwitchFire controls how the sonar returns are displayed in the view.

1. With a Side Imaging View displayed on-screen, tap Sonar [SI] in the status bar, or press the MENU key once.
2. Select SwitchFire.
3. Select Clear Mode or Max Mode.

Clear Mode	Choose Clear Mode to see less clutter and more fish size accuracy on the display. When Clear Mode is selected, the clutter is filtered, and sonar returns are interpreted to provide more details about the objects within the transducer beam, regardless of their location. In other words, a large arch on the display means a large fish has been detected.
Max Mode	Choose Max Mode to see only raw sonar returns on the display. When Max Mode is selected, you will see the maximum sonar information available within the transducer beam, so more fish arches and better jig tracking are shown.



QUICK TIP! This setting can also be changed in the status bar menu.

Set the Range

Range controls how much of the water column is displayed on the view.

1. With a Side Imaging View displayed on-screen, tap Sonar [SI] in the status bar, or press the MENU key once.
2. Select Range.
3. Tap the slider to select Auto or Man [Manual], or press the ENTER key.

Auto	The Range will be adjusted by the control head to follow the bottom automatically.
Man [Manual]	To adjust the display range, press and hold the slider, or press and hold the ENTER key. Select a low range number to focus on a shorter distance of the water column and see greater detail on the screen. Select a higher range number to view farther into the water and see an overview of details on the screen.

Display Range Markers

To mark a specific range on the view, turn on Range Marker. This menu is available in Custom Mode [see *The Menu System: Change the User Mode*].

1. With a Side Imaging View displayed on-screen, tap Sonar (SI) in the status bar, or press the MENU key once.
2. Select Sonar Options > Range Marker.
3. Select Left Marker or Right Marker.
4. Tap the on/off button, or press the ENTER key, to turn it on.
5. Press and hold the slider, or press and hold the ENTER key, to adjust the setting.

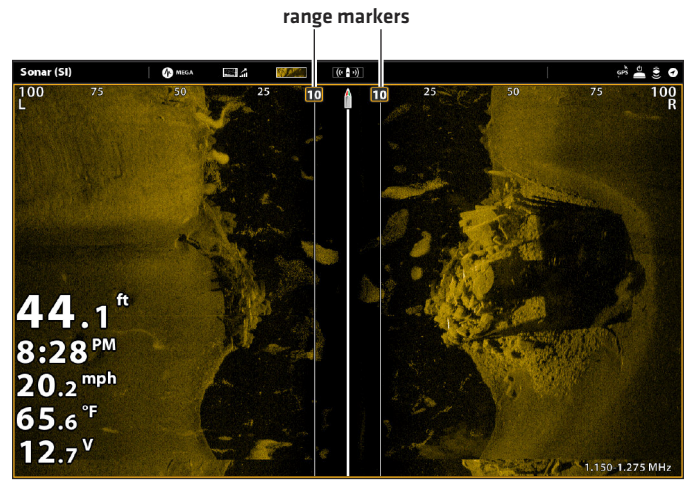

Select Frequencies

If there are multiple beams available in a transducer, you can display individual frequencies on the view. See *Installation Information: Set up your Humminbird Network, Select Sonar Sources* and *Set up or Change Transducer Settings* for details.

1. With a Side Imaging View displayed on-screen, tap the frequency menu in the status bar.

OR

Press the MENU key. Select SI Frequency Select.

2. Select a frequency from the list.



NOTE: If the control head is using a sonar source with only one beam frequency, the frequency list will not offer additional options.



QUICK TIP! This setting can also be changed by pressing and holding the ENTER key.

Adjust the SI Sensitivity Offset

In the unlikely event that your Side Imaging transducers are not tuned to the same level, you can offset the left Side Imaging beam from the right Side Imaging beam.

1. With a Side Imaging View displayed on-screen, tap Sonar (SI) in the status bar, or press the MENU key once.
2. Select Sonar Options.
3. Select SI Sensitivity Offset.
4. Press and hold the slider, or turn the Rotary dial, to adjust the setting.

Adjusting the SI Sensitivity Offset

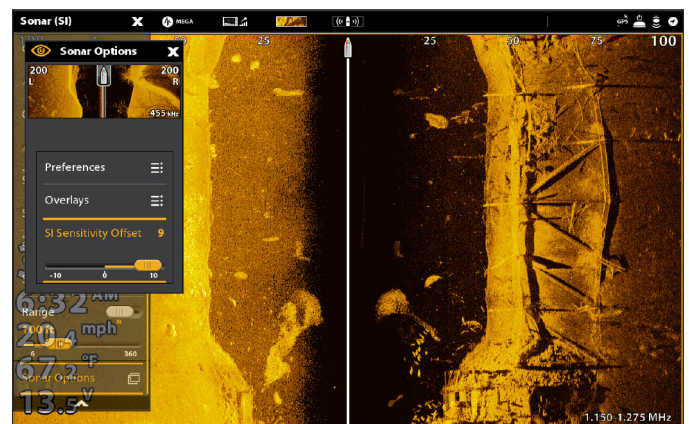

DOWN IMAGING OVERVIEW

(DOWN IMAGING TRANSDUCER OR SIDE IMAGING TRANSDUCER REQUIRED)

The images you see on the Down Imaging display are produced using sonar technology. Each time the unit pings, a strip of data representing all the echoes received by the transducer are put together on the display to form the image that you see. Like traditional 2D Sonar, the sonar history scrolls left across the screen.

Down Imaging beams “illuminate” the bottom contour, structure, and fish. The beams are wide [side to side] but very thin from front to back.

Down Imaging View: Original Palette

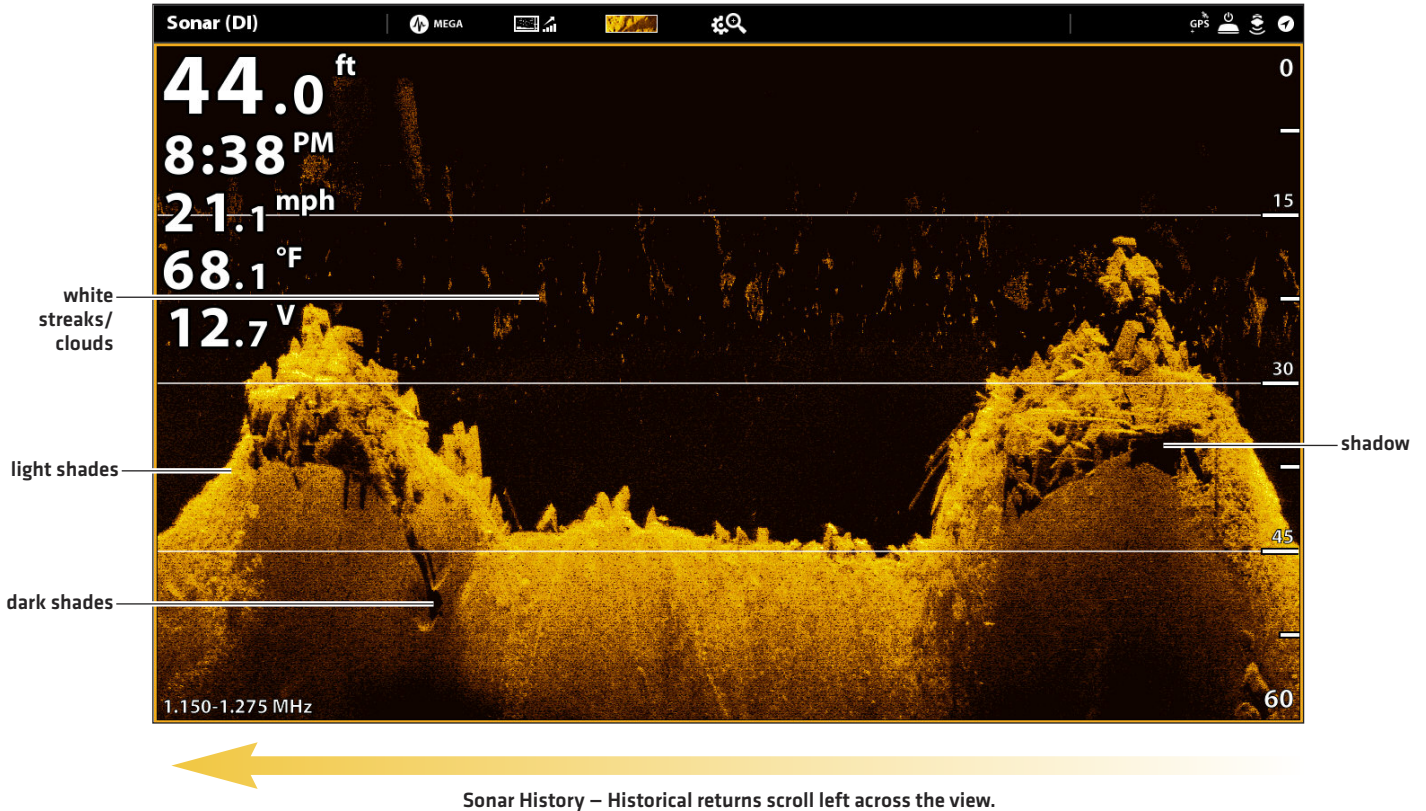

Use the light and dark parts of the display to interpret the objects under your boat as follows:

Dark shades represent soft returns [mud, sand] or descending terrain.

Light shades represent denser terrain [timber, rocks] or rising terrain. A very hard bottom may appear as white on the display.

White Streaks or **Clouds** may represent fish on the display.

Shadows are not caused by light but by the lack of a sonar return. Objects standing on the bottom cause a sonar shadow to appear on the display. The longer the shadow, the taller the object. Fish may also cast shadows. You can use the shadow to interpret where the fish or object is located in relation to the bottom.

CUSTOMIZE THE DOWN IMAGING VIEW

The settings in this section are optional. You can use the default settings for the view, or you can customize it with your preferences. See [Views](#) for more information.

OPEN THE DOWN IMAGING PREFERENCES MENU

The Preferences menu allows you to set the palette, zoom mode, and bottom line. For more information about view preferences, see [Views](#).

1. With a Down Imaging View displayed on-screen, tap Sonar [DI] in the status bar, or press the MENU key once.
2. Select Sonar Options.
3. Select Preferences.

Change the Color Palette

The Sonar Colors menu changes the colors used to display sonar returns on the view.

1. From the Preferences menu, select Palette.
2. Select a color palette.

Down Imaging View with a Customized Palette

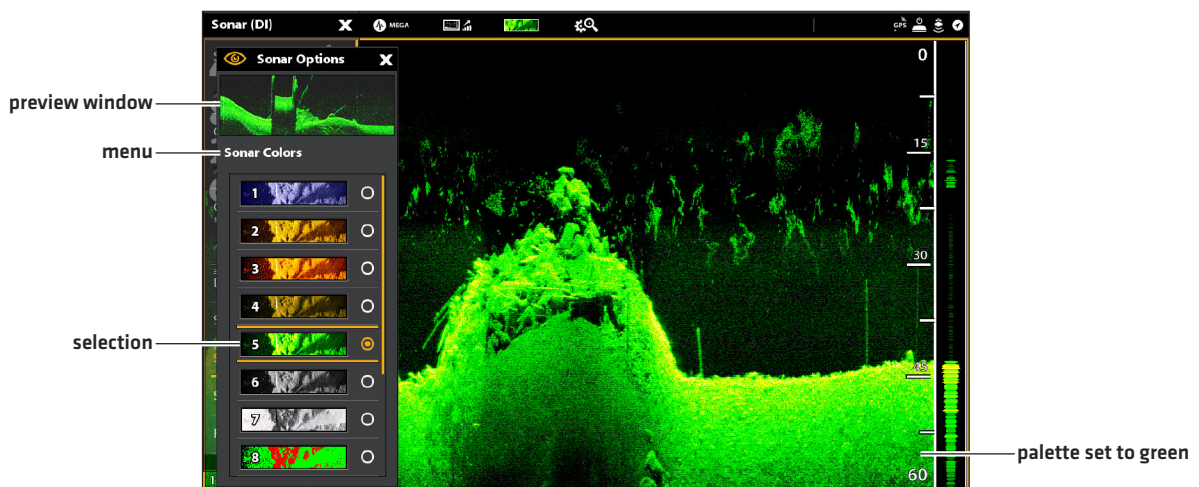

Set the Zoom Mode

The Zoom Mode sets the zoom commands to magnify the full pane or the cursor selection. See *Use Cursor and Zoom in Sonar Views* to apply the zoom features.

1. From the Preferences menu, select Zoom Mode.
2. Select Pane Zoom or Cursor Zoom.

Pane Zoom	When you use pinch out/in [touch screen] to zoom, or press the +/- ZOOM keys, the view will be magnified.
Cursor Zoom	When you use pinch out/in [touch screen] to zoom, or press the +/- ZOOM keys, the cursor selection will be magnified.

Display the Bottom Line

Add a check mark to Bottom Line to display the depth reading from the Depth Source as a line, either from the selected transducer or another digital depth source. See *Set up your Humminbird Network* for details about selecting sources.

1. From the Preferences menu, tap Bottom Line or press the ENTER key.

Down Imaging View with Bottom Line Displayed

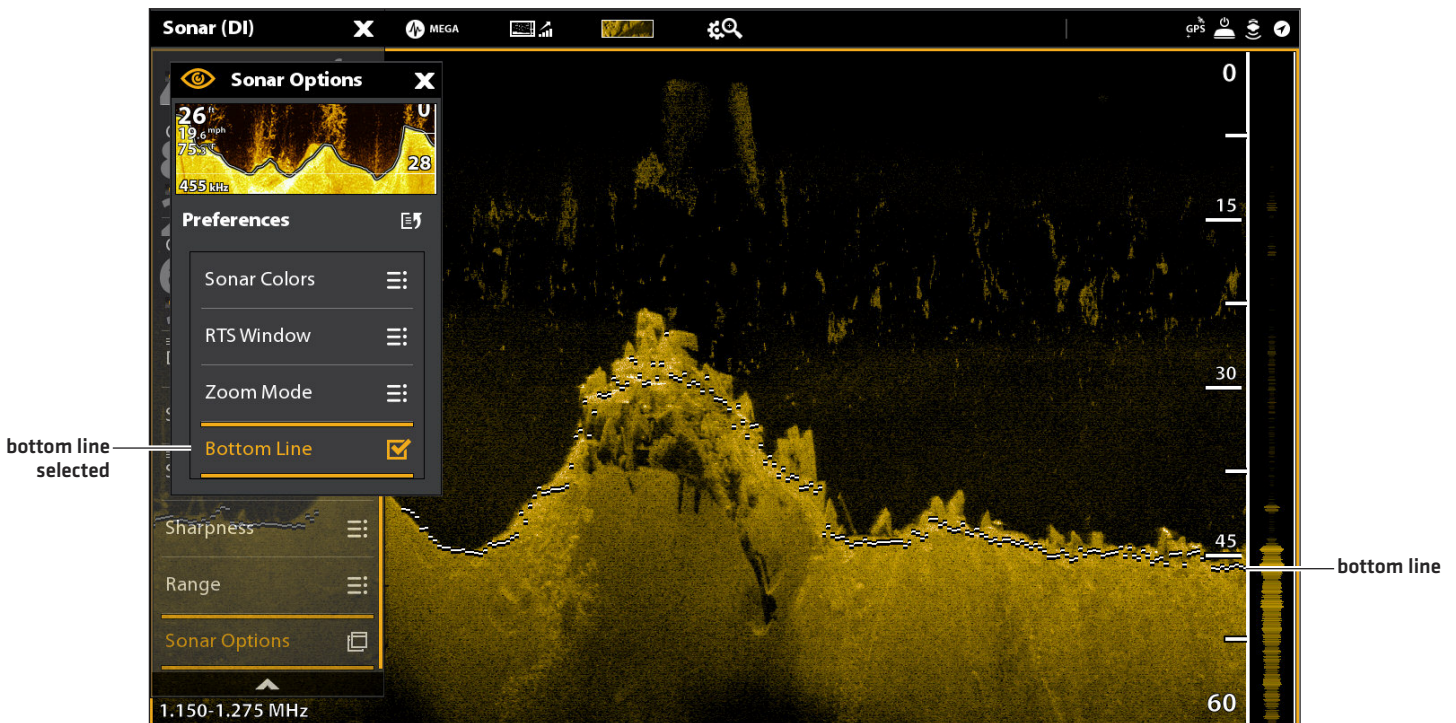

CHANGE THE DOWN IMAGING VIEW OVERLAYS

Use the Overlays menu to display or hide information on the view. In the Down Imaging View, you can display the following: depth range, beam frequency label, and data overlays. Digital readout data can be displayed as an overlay, and it can be displayed in the data bar. To turn on the data bar, see **Views: Display a Data Bar**. For more information about data overlays, see **Views**.

1. With a Down Imaging View displayed on-screen, tap Sonar [DI] in the status bar, or press the MENU key once.
2. Select Sonar Options.
3. Select Overlays.
4. Tap the menu, or use the Joystick to select an item, and add a check mark. [check mark = visible, blank = hidden].

Selecting Overlays for the Down Imaging View

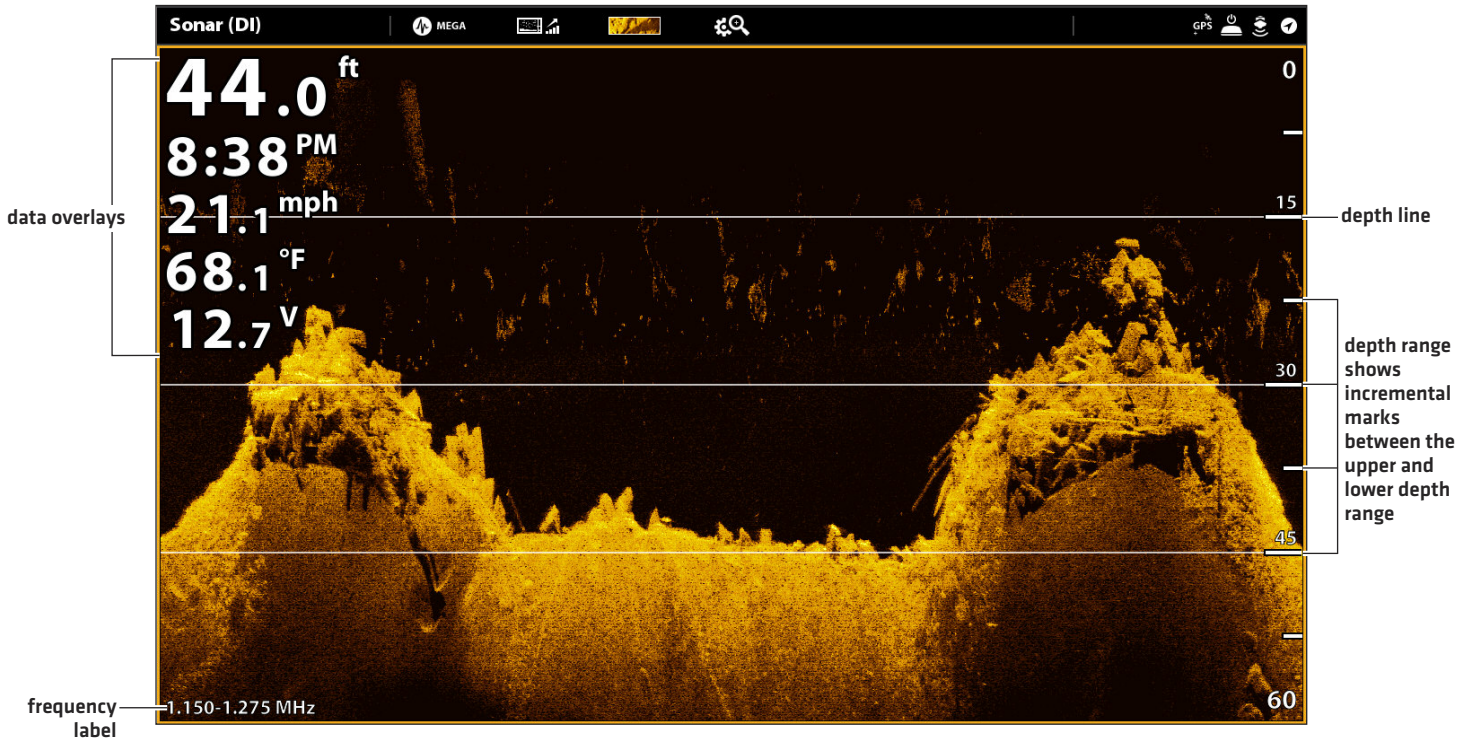

ADJUST DOWN IMAGING DISPLAY SETTINGS

The X-Press Menu provides menu options to adjust the sensitivity and range as you fish. You can also mark a particular depth, and you can control how fast the sonar history scrolls across the screen. The menu options allow you to see more or less of the sonar returns from the transducer beams as you adjust each setting.

Adjusting Down Imaging Display Settings

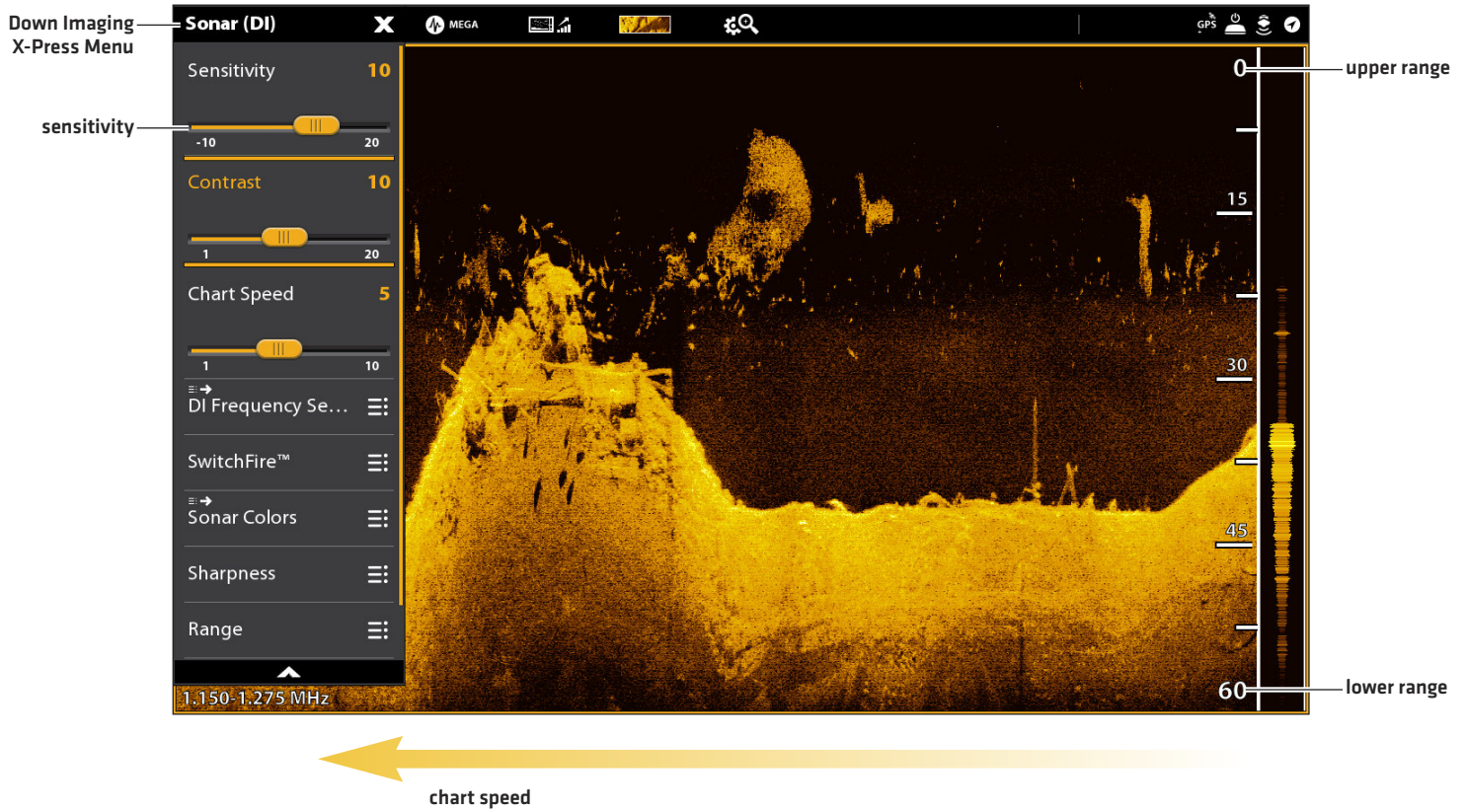

Adjust Display Settings

1. With a Down Imaging View displayed on-screen, tap Sonar [DI] in the status bar, or press the MENU key once.
2. Select Sensitivity, Contrast, Chart Speed, or Sharpness.
3. Press and hold the slider, or turn the Rotary dial, to adjust the setting.

Sensitivity	Sensitivity controls how much detail is shown on the display and will adjust the sensitivity of all sonar frequencies. Decrease the sensitivity to eliminate the clutter from the display that is sometimes present in murky or muddy water. When operating in very clear water or greater depths, increase the sensitivity to see weaker returns that may be of interest.
Contrast	Adjust the Contrast setting to accent the light and dark parts of the Down Imaging data to provide greater definition.
Chart Speed	Chart Speed determines how fast the sonar history moves across the display and how much detail is shown. Select a faster speed to see more detail. Select a slower speed to keep the sonar history on the display longer.
Sharpness	Turn on sharpness and select a filter level to sharpen the edges of the Down Imaging data.

Change the SwitchFire Mode

SwitchFire controls how the sonar returns are displayed in the view.

1. With a Down Imaging View displayed on-screen, tap Sonar [DI] in the status bar, or press the MENU key once.
2. Select SwitchFire.
3. Select Clear Mode or Max Mode.

Clear Mode	Choose Clear Mode to see less clutter and more fish size accuracy on the display. When Clear Mode is selected, the clutter is filtered, and sonar returns are interpreted to provide more details about the objects within the transducer beam, regardless of their location. In other words, a large arch on the display means a large fish has been detected.
Max Mode	Choose Max Mode to see only raw sonar returns on the display. When Max Mode is selected, you will see the maximum sonar information available within the transducer beam, so more fish arches and better jig tracking are shown.



QUICK TIP! You can also select this menu on the status bar.

Set the Range

Range controls how much of the water column is displayed on the view. For example, if you are only interested in the area between 20 and 50 feet deep, set the Upper Range to 20 and the Lower Range to 50. The view will not display sonar returns outside of the set ranges, and greater detail for the selected range will be displayed.

1. With a Down Imaging View displayed on-screen, tap Sonar [DI] in the status bar, or press the MENU key once.
2. Select Range.
3. Select Upper Range. Press and hold the slider, or press and hold the ENTER key, to adjust the setting.
4. Select Lower Range.

Auto: Move the slider to Auto. The Lower Range will be adjusted by the control head to follow the bottom automatically.

Man [Manual]: Move the slider to Manual and adjust the setting.

Display the Depth Marker

To mark a specific depth on the view, turn on Depth Marker. This menu is available in Custom Mode [see *The Menu System: Change the User Mode*].

1. With a Down Imaging View displayed on-screen, tap Sonar [DI] in the status bar, or press the MENU key once.
2. Select Sonar Options > Depth Marker.
3. Tap the on/off button, or press the ENTER key, to turn it on.
4. Press and hold the slider, or press and hold the ENTER key, to adjust the setting.

Select Frequencies

If there are multiple beams available in a transducer, you can display individual frequencies on the view. See *Installation Information: Set up your Humminbird Network, Select Sonar Sources* and *Set up or Change Transducer Settings* for details.

1. With a Down Imaging View displayed on-screen, tap the frequency menu in the status bar.

OR

Press the MENU key. Select DI Frequency Select.

2. Select a frequency from the list.



NOTE: If the control head is using a sonar source with only one beam frequency, the frequency list will not offer additional options.



QUICK TIP! This setting can also be changed by pressing and holding the ENTER key.

You can use the cursor in the 2D Sonar, Side Imaging, and Down Imaging Views. With the cursor activated, you can magnify sonar returns on the view to get a closer look.



NOTE: To display the 2D Sonar View in Split Zoom mode, see *Customize the 2D Sonar View: Change the Sonar Mode*.

Change the Zoom Mode

In 2D Sonar View and Down Imaging View, the sonar returns will be magnified based on the Zoom Mode setting. You can magnify the full view [Pane Zoom] or a selected area of the view [Cursor Zoom]. See *Customize the 2D Sonar View* or *Customize the Down Imaging View* for more information.



QUICK TIP! You can also select this menu on the status bar.

Touch Screen

1. With a 2D Sonar View or Down Imaging View displayed on-screen, tap Sonar in the status bar.
2. Select Sonar Options.
3. Select Preferences.
4. Select Zoom Mode.
5. Select Pane Zoom or Cursor Zoom.

Keypad

1. With a 2D Sonar View or Down Imaging View displayed on-screen, press the MENU key once.
2. Select Sonar Options.
3. Select Preferences.
4. Select Zoom Mode.
5. Select Pane Zoom or Cursor Zoom.

Activate the Cursor

Touch Screen

1. Tap a position on the 2D Sonar, Down Imaging, or Side Imaging View.

Keypad

1. Move the Joystick.

Zoom In/Out

Touch Screen

1. **Zoom In:** Tap the position twice [double tap].
2. **Zoom Out:** Tap the screen with two fingers once [single tap].

OR

1. **Zoom In:** Touch the screen with two fingers and move them apart [pinch out].
2. **Zoom Out:** Touch the screen with two fingers and move them together [pinch in].

Keypad

1. **Zoom In:** Press the +ZOOM key.
2. **Zoom Out:** Press the - ZOOM key.

Using Cursor Zoom Mode (2D Sonar View)

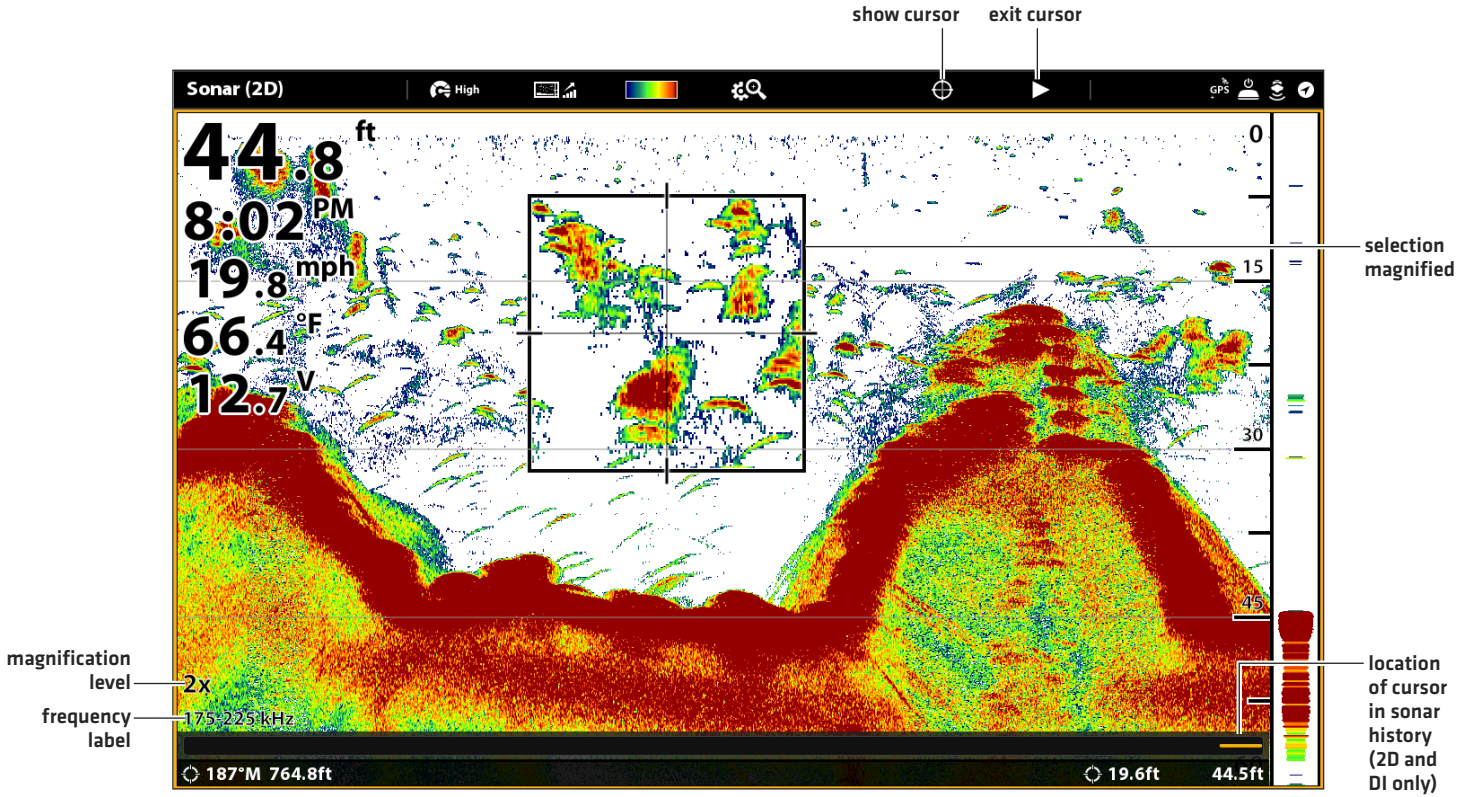

Tap to Activate the Cursor



Pinch out to Magnify the Selection

OR

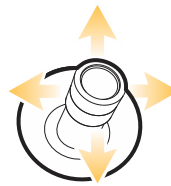

Move the Joystick to Activate the Cursor



Press the + ZOOM key to Magnify the Selection

To mark waypoints and start navigation, the control head must have a GPS fix from a connected or internal GPS receiver. The navigation menus can be accessed from the X-Press Menu, touch screen, and the keypad.

Mark a Waypoint

You can mark a waypoint on the Sonar Views using the keypad or touch screen. You can also mark a waypoint at the vessel position or the cursor position.

Mark a Waypoint at the Vessel Position

Touch Screen

1. Tap Sonar in the status bar.
2. Select Mark.
3. Select Waypoint.

Keypad

1. Press the MARK key twice.

Mark a Waypoint at the Cursor Position

Touch Screen

1. Press and hold a position on the Sonar View.
2. Select Waypoint.

Keypad

1. Use the Joystick to move the cursor to a position on the Sonar View.
2. Press the MARK key twice.

Marking a Waypoint [2D Sonar View]

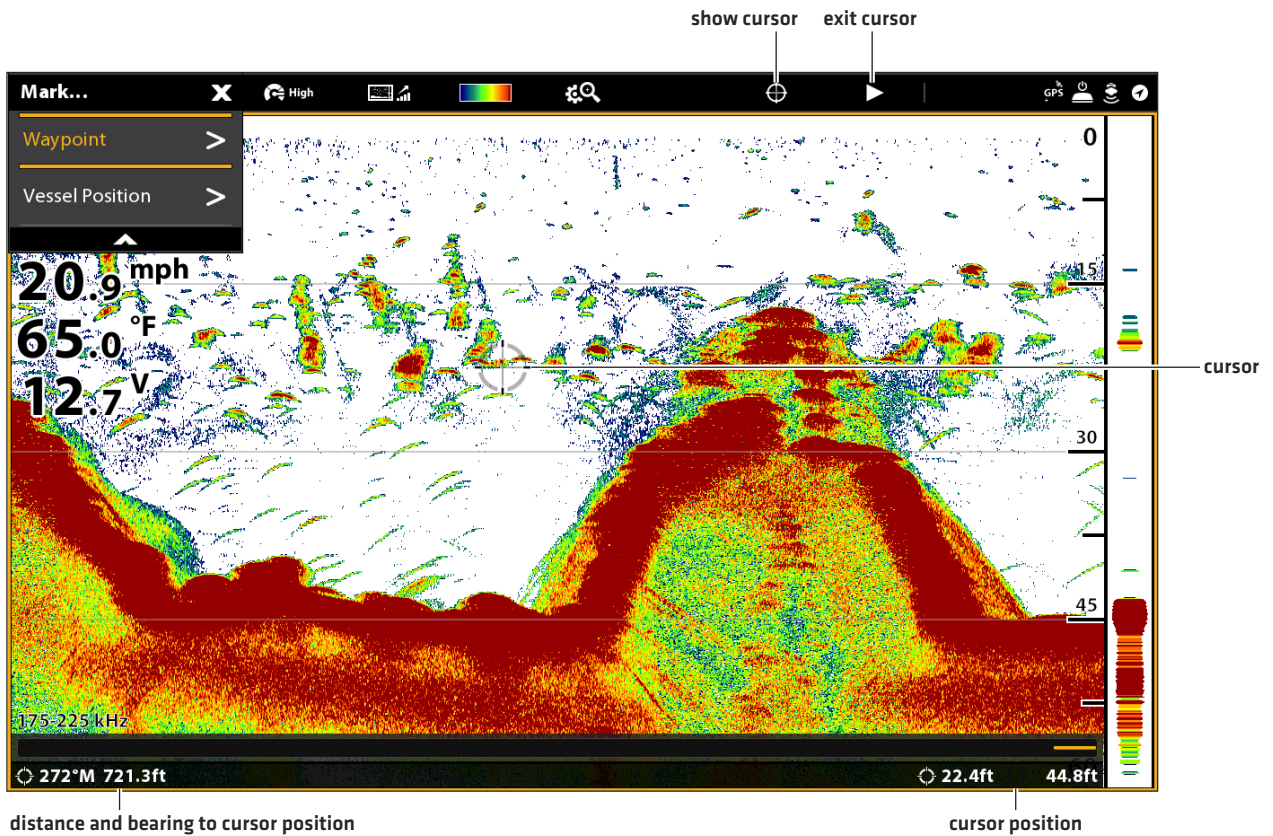

Navigate to a Position

Use the instructions in this section to start navigation to a position in the Sonar Views. See *Introduction to Navigation* for more information about these features.

Start Navigation

Touch Screen

1. Press and hold a position on the Sonar View.
2. Select Go To Cursor.

Keypad

1. Press the GO TO key.
2. **To start navigation to a saved position**, select Nav Data. Select a saved position, and press the GO TO key.

To enter a latitude/longitude position, select Lat/Long.

3. Continue to follow the on-screen prompts to start navigation.



NOTE: In Side Imaging Views, if SI Navigation is turned on, the boat icon will turn to indicate the direction the boat needs to turn to reach the next waypoint during navigation [see *Customize the Side Imaging View: Turn on/off SI Navigation*].

Cancel Navigation

1. During navigation, tap Sonar in the status bar. Select Go To.

OR

Press the GO TO key.

2. Select Cancel Navigation.

SONAR RECORDING

Use the Sonar Recording menu to record active sonar information. Sonar recordings are saved to an installed SD card, and you can play your saved sonar recordings from the Recordings tool. When the recording is played back, the views that were active during the recording are available. You can also adjust the view settings and mark waypoints during playback.

Start Recording

When you start a sonar recording, you can select which beams will be recorded and where the sonar recording will be saved. Sonar Recording can be started from the Sonar X-Press Menu or the Recordings tool. The instructions for the Sonar X-Press Menu are shown here.

1. With a Sonar View [2D, SI, DI] displayed on-screen, tap Sonar in the status bar.

OR

Press the MENU key once.

2. Select Sonar Recording.
3. Set up the sonar recording:
Select Recording Sources, and select the beams to be recorded.
Select Save Location, and select an installed SD card.
4. Select Start Recording.

Stop Recording

1. With a Sonar View [2D, SI, DI] displayed on-screen, tap Sonar in the status bar.

OR

Press the MENU key once.

2. Select Sonar Recording.
3. Select Stop Recording.

Play a Sonar Recording

1. Press the HOME key.
2. Select the Recordings tool.
3. Tap the recording name, or use the Joystick to select it.
4. Select Start.

Open the Playback Control Menu

The Playback Control menu includes stop, pause, forward or reverse for the recording played on the screen.

1. Play a sonar recording.
2. With a Sonar View [2D, SI, DI] displayed on-screen, tap Sonar in the status bar.

OR

Press the MENU key once.

3. Select Sonar Playback.

IMAGES TOOL

The Images tool displays the screen snapshots saved to the control head or to the installed SD cards. You can edit, rename, copy, and delete a screen snapshot. You can also view your saved screen snapshots (JPG files) as a slide show.

Take a Screen Snapshot

Use the screen snapshot feature to take a picture of the on-screen view. The screen snapshot includes the warnings, menus, and messages that were active when the screen snapshot was taken. If Create Waypoint is turned on, a waypoint will be marked when you take the screen snapshot. See **Screen Snapshot Settings** for details.



1. Press and hold the GO TO/Screen Snapshot key.

Open the Images Tool

Open the Images tool to see all the screen snapshots saved to the control head, installed SD cards. You can also view each save location individually, and the images can be sorted by name, date, or file type.

Open the Images Tool

1. Press the HOME key.
2. Select the Images tool.

Browsing Screen Snapshots in the Images Tool

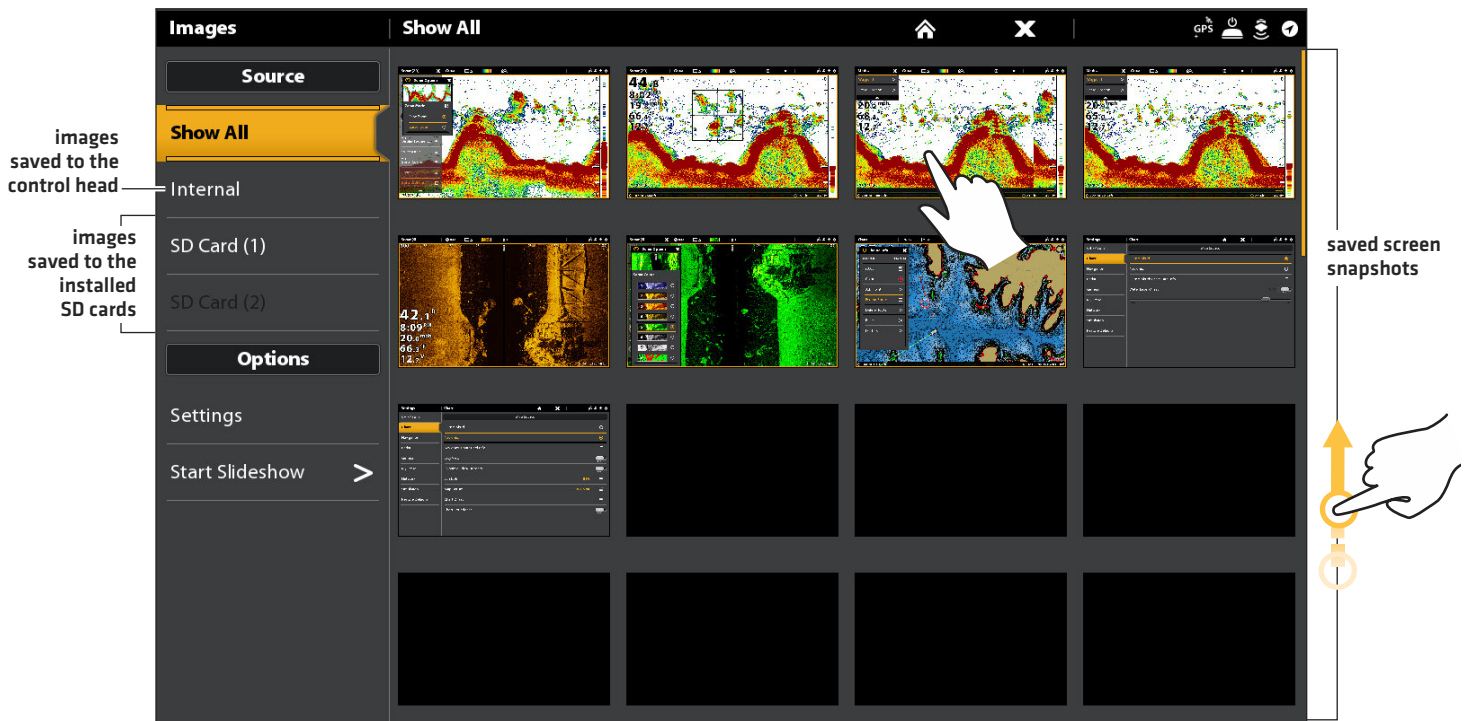

Sort Screen Snapshots

1. From the Images tool, select Settings.
2. Select Sort Options.
3. Select a sort option to sort by Name, Date, or File Type.

To view the images from newest to oldest, select Reverse Order. Tap the on/off button, or press the ENTER key, to turn it on.

Screen Snapshot Settings

Screen snapshots are automatically saved to the control head as JPG files. To save screen snapshots to an SD card, set up the save location in advance. If you turn on Create Waypoint, each time a screen snapshot is taken, the waypoint position will be saved.

Save Screen Snapshots to an SD Card

1. Install an SD card into a control head port.
2. Press the HOME key.
3. Select the Images tool.
4. Select Settings.
5. Under Screen Capture Save Location, select an installed source. [left port = SD Card 1 or right port = SD Card 2; Default = Internal control head]

Selecting a Save Location

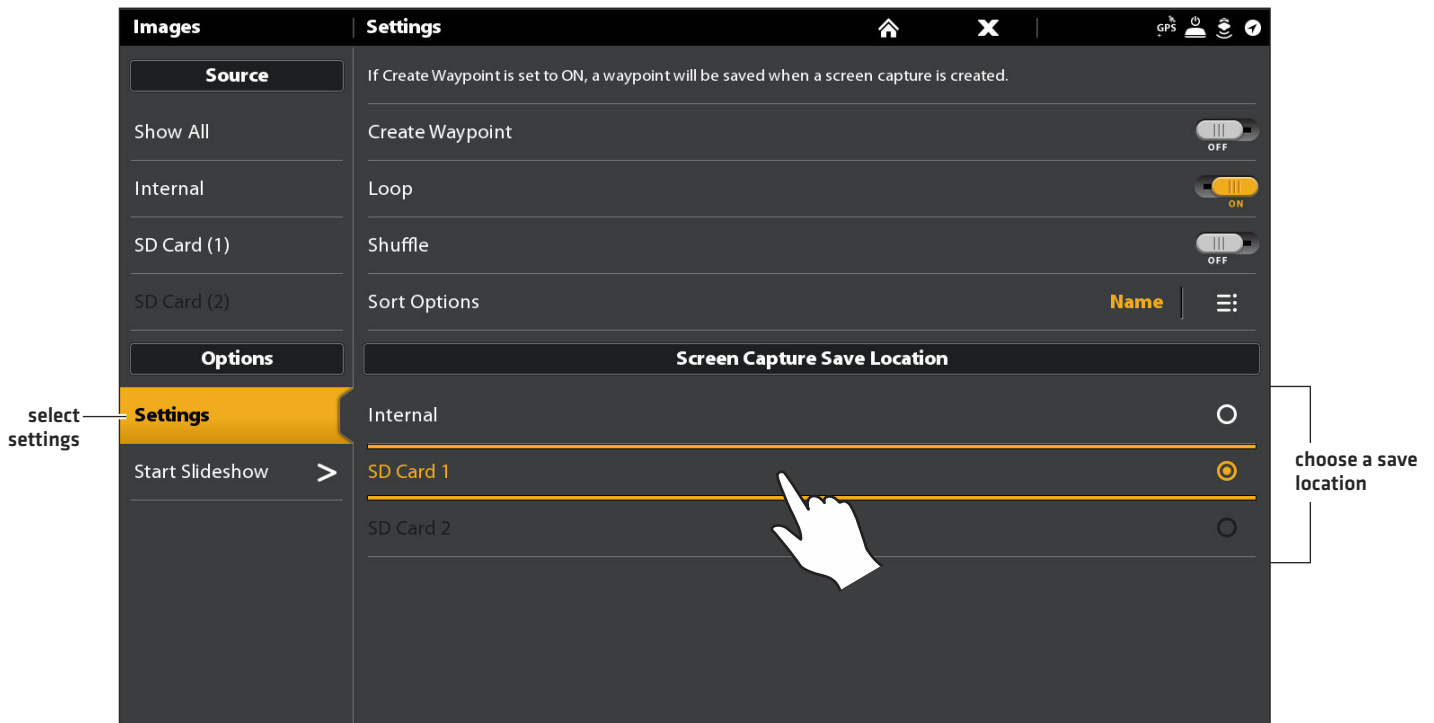

Create a Waypoint with Screen Snapshot

If you turn on Create Waypoint in the Images tool, each time a screen snapshot is taken, the waypoint position will be saved.

1. Press the HOME key.
2. Select the Images tool.
3. Select Settings.
4. Select Create Waypoint. Tap the on/off button, or press the ENTER key, to turn it on.

When a screen snapshot is taken with Create Waypoint turned on, the screen snapshot will display a waypoint icon in the Images tool preview.

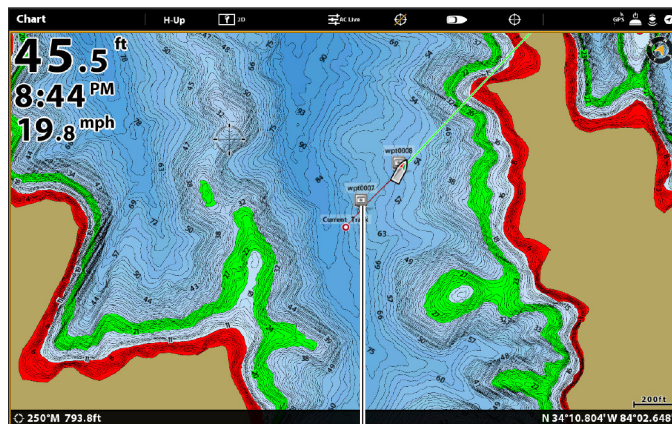

screen snapshot saved with
Create Waypoint turned on

Display Screen Snapshots and Slideshow

When you select a saved screen snapshot [JPG file] from the Images tool, you can display it in full-screen using the touch screen or keypad.

Using the Touch Screen with a Saved Screen Snapshot

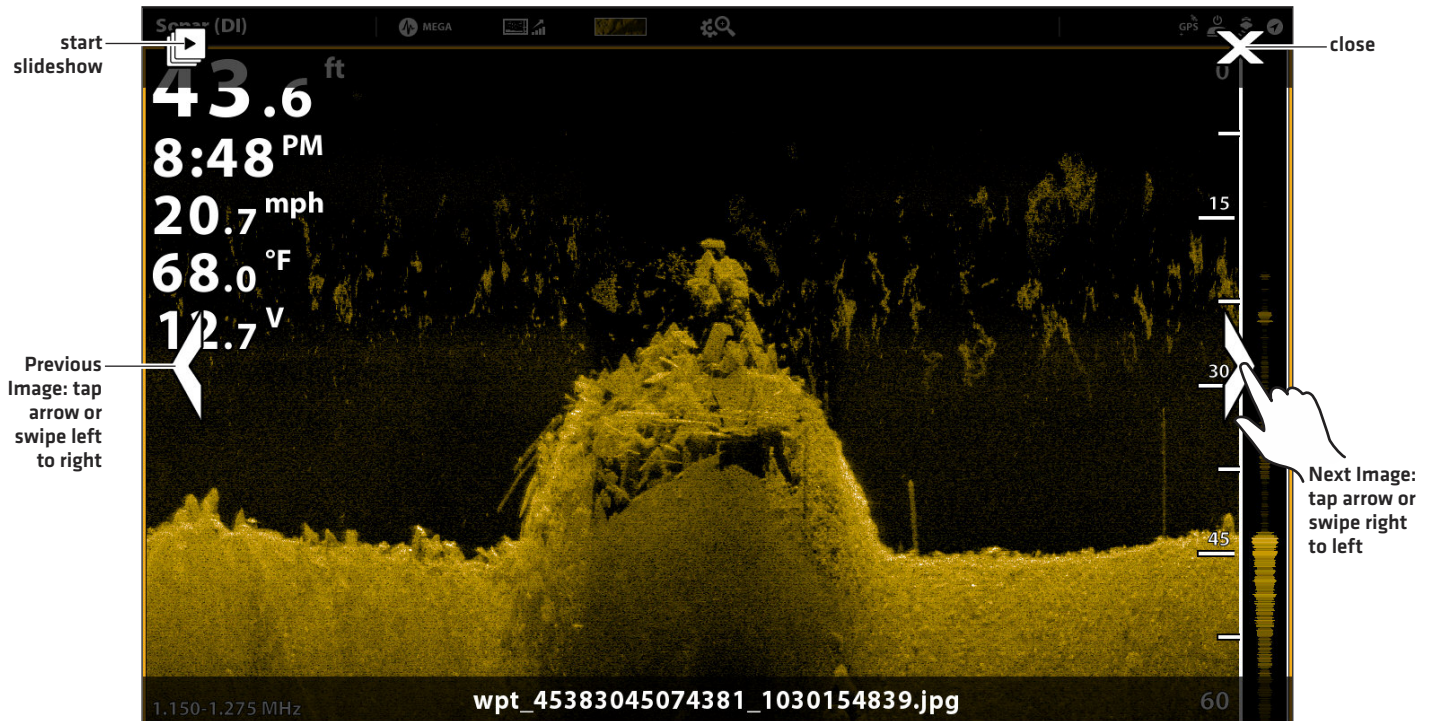

Display a Screen Snapshot

Touch Screen

1. From the Images tool, tap a screen snapshot.

Scroll to the Next Image/Previous Image:

Tap the on-screen arrows.

Return to the Images Tool:

Tap the on-screen X icon.

Keypad

1. Use the Joystick to select a screen snapshot.
2. Press the ENTER key.

Scroll to the Next Image/Previous Image:

Turn the Rotary dial.

Return to the Images Tool:

Press the EXIT key.

Set up the Slideshow

Screen snapshots and pictures from your camera's SD card can be displayed in a slideshow. You can use the control head default settings to play the slide show, or you can set the slideshow to loop or shuffle.

1. From the Images tool, select Settings.
2. To set up the slide show so it runs continuously, turn on Loop.
To set up the slide show so it displays screen snapshots randomly, turn on Shuffle.

Play the Slideshow

1. Under Options, select Start Slideshow.
2. **Stop:** Tap the screen, and press the X icon on the screen.

OR

Press the EXIT key.

Edit Screen Snapshots

The Images Options menu allows you to edit the name and review the file information for the selected screen snapshot. You can also copy screen snapshots to another save location or delete them.

Change a Screen Snapshot Name

1. From the Images tool, press and hold a screen snapshot.

OR

Use the Joystick to select a screen snapshot. Press the MENU key.

2. Select Name. Use the on-screen keyboard to enter a name.
3. Select Save.

Review Screen Snapshot Information

When you save a screen snapshot, the date and time the screen snapshot was taken is saved. If Create Waypoint is turned on, the position and waypoint name are also saved with the screen snapshot. Use these instructions to review the saved information.

1. From the Images tool, press and hold a screen snapshot.

OR

Use the Joystick to select a screen snapshot. Press the MENU key.

2. Select Info.

Copy a Screen Snapshot

1. From the Images tool, press and hold a screen snapshot.

OR

Use the Joystick to select a screen snapshot. Press the MENU key.

2. Select Copy.

To copy all screen snapshots, select Copy All.

3. Select a location to save the copy.

Delete a Screen Snapshot

1. From the Images tool, press and hold a screen snapshot.

OR

Use the Joystick to select a screen snapshot. Press the MENU key.

2. Select Delete.

To delete all screen snapshots, select Delete All.

INSTALLATION INFORMATION

This section includes information that may be required to connect new equipment or a new accessory to the control head. There are several configurations available for your SOLIX control head. You can network control heads, connect accessories to an Ethernet network, connect to a NMEA 2000 network, and add transducers to your system through black box sonar. For configuration options and the latest Humminbird accessories, visit our Web site at humminbird.com.

Installation guides are included with each hardware component to install equipment purchased separately (transducer, heading sensor, radar, AIS, autopilot, and accessories). See your installation guides for details.

Unused Ports: Any unused ports should be covered with the port covers to prevent potential damage to the control head.

Cables: We also recommend that you label the cables with waterproof tags for future reference.



WARNING! Before you connect cables to the control head, or disconnect cables, the control head power and equipment power sources must be turned off.



CAUTION! Before you update the control head software, synchronize units on the network, or restore system defaults, export your control head menu settings to an SD card. It is also recommended to export your navigation data to an SD card. See **Update Software** for details.



NOTE: If you have questions about the installation or troubleshooting, see your control head installation guide. Also, contact Humminbird Customer Service at humminbird.com.

SET UP OR CHANGE TRANSDUCER SETTINGS

(OPTIONAL)

When you connect a transducer to a black box sonar or to the SOLIX control head, the transducer will be detected in the network automatically. The best transducer source will be chosen and start pinging automatically. If you connect an accessory transducer to the network, the unit will recognize the new transducer.

The instructions in this section are **optional** and can be used to address the following situations:

Initial Setup: If a transducer is connected to a control head but not detected, **Initial Setup** will be displayed under Transducer Setting [see the illustration below]. If the transducer is detected, the transducer type is displayed under Transducer Setting [for example: 2D + DI + SI], and the transducer is already set up in the system, and no further action is required.

Review the Transducer Capabilities [optional]: The Transducer Setup menu is used to activate the full functionality of the transducer. Make sure the transducer functions include a check mark. Add a check mark next to the transducer type, beams, and temperature probe [if included].

Adjust the Depth Offset [optional]

Adjust the Max Depth [optional]



NOTE: For black box sonar and sonar networking information, see **Set up your Humminbird Network**. Also, to set up an Airmar transducer, or for troubleshooting information, download the Transducer Setup Guide from our Web site at humminbird.com.



NOTE: Humminbird has provided the best settings for your unit. You can use the settings included with your control head, or you can adjust these advanced options.

Set up or Change Transducer Settings (optional)

Use the instructions in this section to enable a transducer with its complete functionality.

1. Press the HOME key.
2. Select Settings.
3. Select CHIRP Sonar.
4. Select Sonar Source.
5. Select Initial Setup.

If the transducer has been set up, but you want to change a transducer setup setting, select the  menu icon.

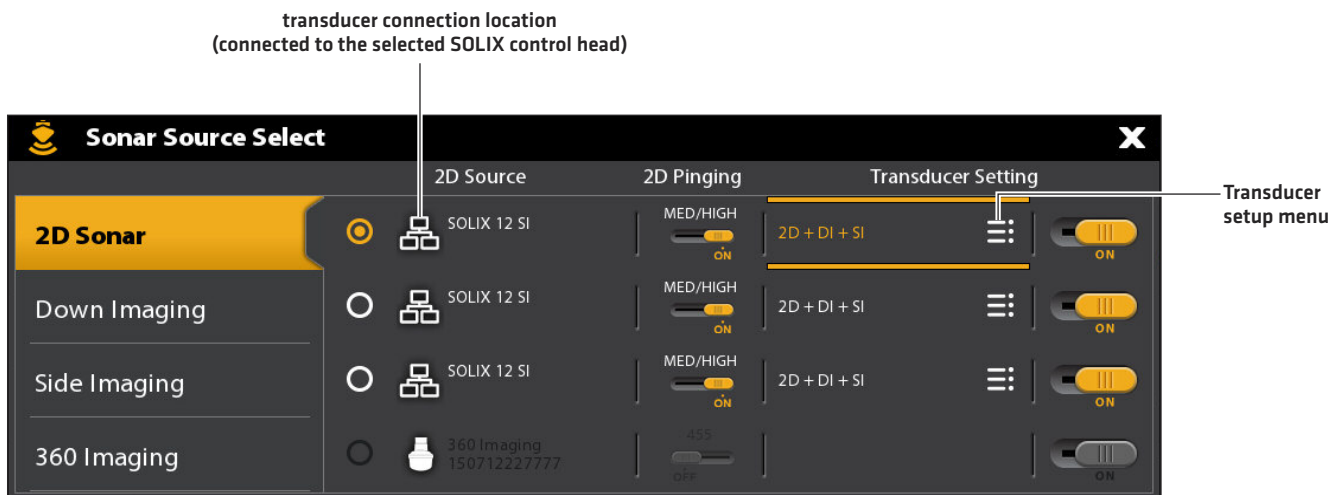

6. **Sonar Capabilities:** On the Transducer Setup menu, add a check mark next to each sonar capability for the selected transducer.

For example, for a 2D transducer, the 2D Sonar menu needs to be checked. For a Side Imaging transducer, 2D Sonar, SI Sonar, and DI Sonar need to be checked because the transducer includes all three capabilities. See the illustrations for examples.

 **NOTE:** The capabilities of your sonar model are shown on the packaging, or you can find your transducer on our Web site at humminbird.com.

7. **Frequencies:** Select the Frequency Capability Menu under each checked sonar capability. Confirm that all frequencies in the list are selected, so all frequencies are enabled. [You can select individual frequencies to view at a later time.]
8. **Temp:** If the transducer includes a temperature probe, add a check mark to Temp.
9. **Max Depth (optional):** When Max Depth is set to Auto, the maximum depth is determined by the transducer frequency, and the control head will acquire bottom readings as needed [within the capacity of the unit]. Auto is the recommended setting for this menu.

To manually set the Max Depth, select MAN [Manual], and adjust the slider to the maximum depth setting. The transducer will not attempt to acquire sonar data below that depth, so more detail will be shown on the sonar view.
10. **Depth Offset (optional):** Depth Offset adjusts the digital depth readout to indicate the distance from the transducer to the waterline.
11. Repeat the steps in this section for each transducer as needed.

 **NOTE:** Make sure all capabilities have a check mark so the full functionality of the transducer is enabled. To select sonar sources from the network, see **Set up your Humminbird Network**.

 **NOTE:** The menu options are determined by the connected transducer.

2D Transducer Setup (83/200 kHz or 50/200 kHz)

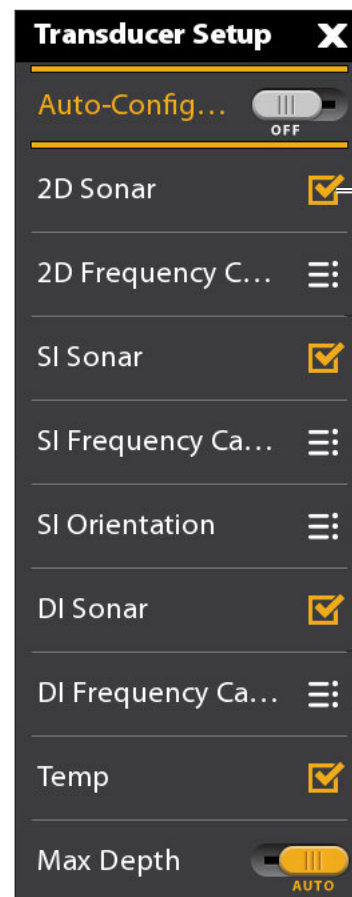

Add a check mark to 2D Sonar to enable 2D capabilities.

To enable the full functionality of the transducer, add a check mark to each category the transducer is capable of pinging.

Select Beams and Display Frequencies

If the selected transducer [sonar source] includes more than one beam, you can select which beam will be displayed in the sonar view. The beams selected in this menu affect all units that are sharing the sonar source. See **Set up your Humminbird Network: Select Sonar Sources** for details.

Select Frequencies for the 2D Sonar View (optional)

The frequencies selected in this menu affect all units that are sharing the sonar source. For example, if you select the blended Medium/High Frequency Select mode for one control head, and you select the single Medium Frequency Select mode on another control head, the control head with the single Medium Frequency selection will still be pinging the High Frequency in the background even though it is not displayed on the view.

 **NOTE:** Humminbird has provided the best settings for your unit. You can use the settings included with your control head, or you can adjust these advanced options.

 **QUICK TIP!** You can also select this menu on the status bar and in the X-Press Menu in 2D Sonar View.

1. Press the HOME key.
2. Select Settings.
3. Select CHIRP Sonar.
4. Under 2D CHIRP, select 2D CHIRP Frequency Select.
5. Select a frequency.

See the **Frequency Select Options** tables on the following pages. To access all beams in the 2D Sonar View, but view individual frequencies on different control heads, select Auto, Medium, or Medium/High Frequency.

Selecting 2D CHIRP Sonar Frequencies

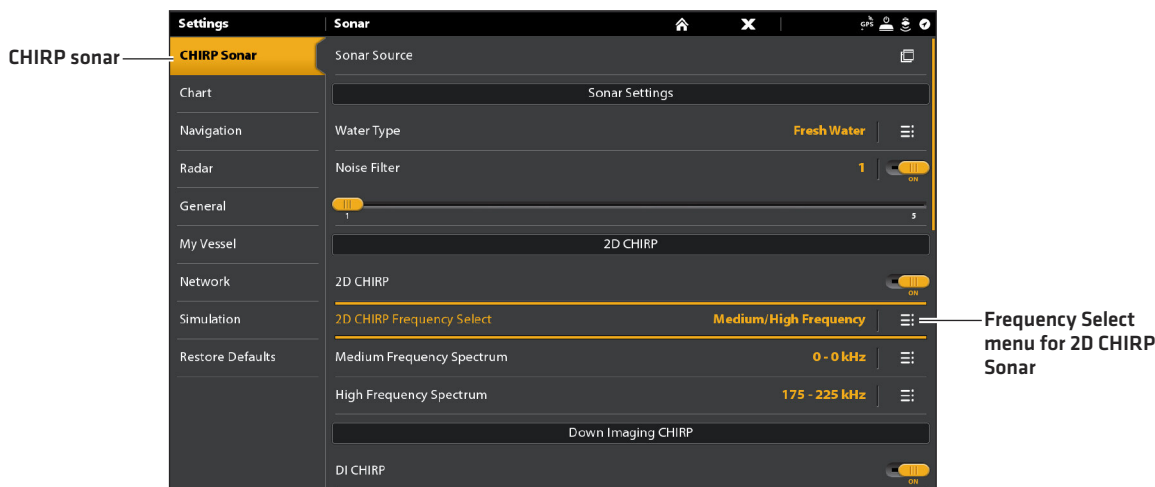

2D Frequency Select (CHIRP Off, On)	
Auto	<p>Auto is the default selection. When Auto is selected, all sonar source beams are available for display in the 2D Sonar View.</p> <p>When Auto is selected, the transducer will only ping when the 2D Sonar View is being used, which may cause interruptions in the sonar history if the view is closed and then reopened. To display sonar history without interruption, select the blended Medium/High Frequency beams.</p>
Medium Frequency	<p>Select Medium Frequency for deep water [more than 800 feet]. Medium Frequency can be used for deep returns at high speed. If Medium Frequency is selected, the high frequency beam pings in the background but is not displayed.</p>
High Frequency	<p>Select High Frequency for more detail at shallower depths [less than 800 feet]. If High Frequency is selected, the medium frequency beam is not available.</p>
Medium/High Frequency	<p>Select Medium/High Frequency to ensure both beams ping continuously, so the sonar history is not interrupted if the Sonar View is closed.</p> <p>The returns from both beams are blended by starting with the wide beam return, dimming it, and then overlaying it with the narrow beam return. The narrow beam sonar returns will stand out from the wide beam sonar returns.</p>

Select and Display Frequencies for the Side Imaging View (optional, CHIRP MEGA SI models only)

Use the instructions in this section to choose a frequency that will be used for the Side Imaging View.



QUICK TIP! You can also select this menu on the status bar and in the X-Press Menu in Side Imaging View.

1. Press the HOME key.
2. Select Settings.
3. Select CHIRP Sonar.
4. Under Side Imaging CHIRP, select SI Frequency Select and Display.
5. Select a frequency.

See the *SI Frequency Select and Display Options* table below.

CHIRP MEGA SI Models SI Frequency Select and Display Options (CHIRP Off, On)	
MEGA	Select MEGA for the highest resolution, sharpness, and range [up to 250 ft side to side].
800 kHz	Select 800 kHz as an alternative frequency with sharp returns [up to 250 ft side to side].
455 kHz	Select 455 kHz for deep water and overall coverage [up to 800 ft side to side].

Select and Display Frequencies for the Down Imaging View (optional, CHIRP MEGA SI models only)

Use the instructions in this section to choose a frequency that will be used for the Down Imaging View. The menu options are determined by the installed transducer and control head model.



QUICK TIP! You can also select this menu on the status bar and in the X-Press Menu in Down Imaging View.

1. Press the HOME key.
2. Select Settings.
3. Select CHIRP Sonar.
4. Under Down Imaging CHIRP, select DI Frequency Select and Display.
5. Select a frequency.

See the *DI Frequency Select and Display Options* table.

CHIRP MEGA SI Models DI Frequency Select and Display Options (CHIRP Off, On)	
MEGA	Select MEGA for the highest resolution, sharpness, and range [up to 125 ft].
800 kHz	Select 800 kHz as an alternative frequency with sharp returns [up to 125 ft].
455 kHz	Select 455 kHz for deep water and overall coverage [up to 400 ft].

Adjust the CHIRP Frequency Spectrum (optional)

Your control head has been configured with the best settings for a wide range of fishing conditions, and we recommend using the entire CHIRP frequency spectrum included with your unit. However, you can adjust the CHIRP Frequency Spectrum to limit the interferences on the display or refine the settings to your preference. The menu options are determined by the installed transducer and control head model.

Requirements: CHIRP mode must be turned on. The menus are also determined by the display frequency you have selected for each view.



WARNING! If an accessory transducer is installed, confirm it is configured in the control head. See **Set up or Change Transducer Settings** for details. For information about accessory transducers, visit our Web site at humminbird.com.

Adjust the CHIRP Frequency Spectrum (2D CHIRP, SI CHIRP, DI CHIRP)

1. Press the HOME key.
2. Select Settings.
3. Select CHIRP Sonar.
4. Under 2D CHIRP, Down Imaging CHIRP, or Side Imaging CHIRP, select the Frequency Spectrum menu.
5. Select Start Frequency or End Frequency.
6. Press and hold the slider, or press and hold the ENTER key, to set the frequency.
7. **Repeat:** Repeat steps 5 and 6 to adjust both the Start Frequency and End Frequency.
8. **Close:** Press the EXIT key.
9. **Repeat:** Repeat steps 4 through 8 to set the Start Frequency and End Frequency for each sonar type and beam you are using.



NOTE: You can also adjust the single frequency range when CHIRP is off. See **Turn On/Off CHIRP Sonar**.

Setting the 2D CHIRP Frequency Spectrum

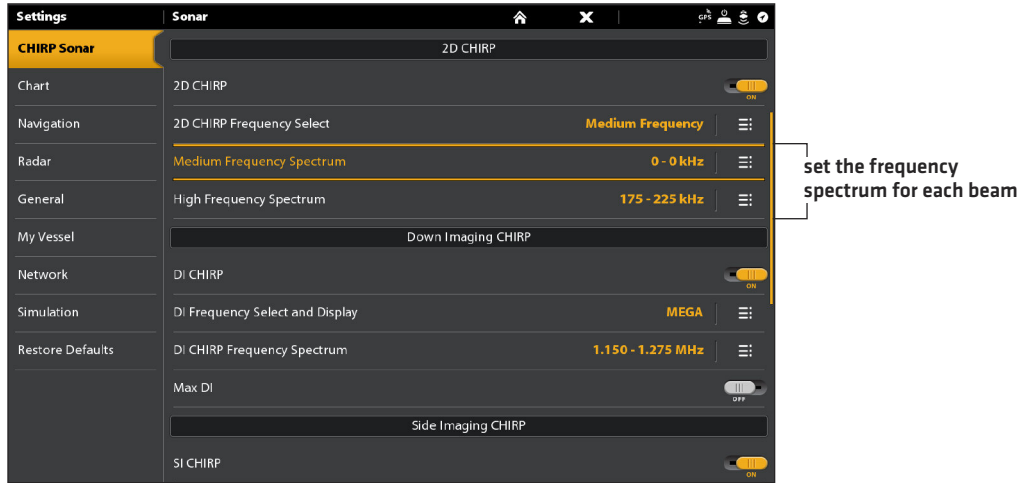

Turn On/Off CHIRP Sonar

To view digital CHIRP sonar, CHIRP must be turned on. To view single frequency sonar, turn CHIRP off. You can also adjust the single frequency range.

1. Press the HOME key.
2. Select Settings.
3. Select CHIRP Sonar.
4. Select 2D CHIRP, DI CHIRP, or SI CHIRP.
5. Tap the on/off button, or press the ENTER key, to turn it on or off.

Turning 2D CHIRP Sonar Off

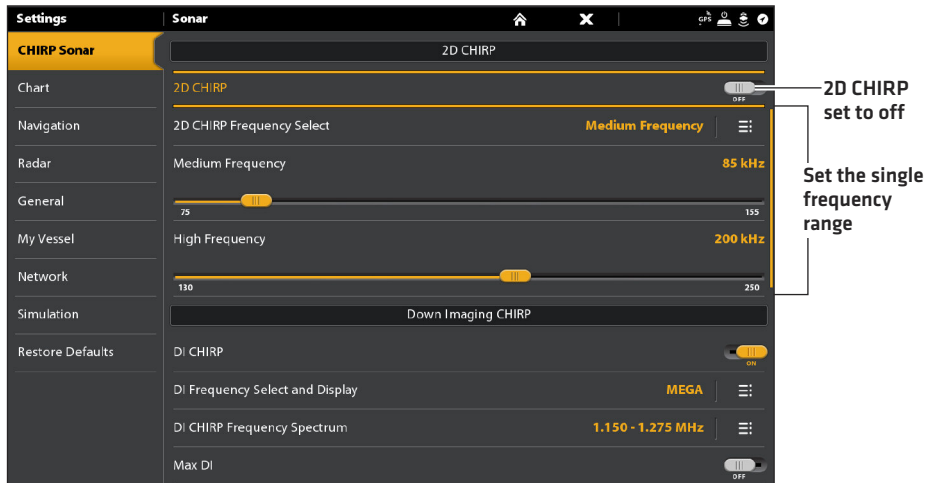

Change the Water Type

Use the instructions in this section to change the Water Type setting.

1. Press the HOME key.
2. Select Settings
3. Select CHIRP Sonar.
4. Under Sonar Settings, select Water Type.
5. Select Fresh Water, Salt Water [200 ft [61 m] or deeper], or Salt Water Shallow [20 ft [6.1 m] or less]. Tap the item or use the Joystick to make your selection.

Adjust the Noise Filter

Use Noise Filter to limit the interference that may appear on the sonar views from sources such as your boat engine, turbulence, or other sonar devices.

1. Press the HOME key.
2. Select Settings
3. Select CHIRP Sonar.
4. Under 2D CHIRP, Down Imaging CHIRP, or Side Imaging CHIRP, select Noise Filter.
5. Tap the on/off button, or press the ENTER key, to turn it on.
6. Press and hold the slider, or turn the Rotary dial, to adjust the setting.

Change the Side Imaging Orientation (CHIRP MEGA SI models only)

Use SI Orientation to switch how the Side Imaging beams are displayed on the Side Imaging View. This menu option can be used if the port and starboard beams are reversed during installation, which might be the case if a transducer is installed incorrectly. For further assistance, contact Humminbird Customer Service.

1. Press the HOME key.
2. Select Settings
3. Select CHIRP Sonar.
4. Select Sonar Source.
5. Under Side Imaging, select the Side Imaging source.
6. Open the Transducer Setup menu. Select SI Orientation.
7. **To display the beams as the transducer[s] is installed**, select Normal.

To change how the beams are displayed so that port and starboard are switched, select Reverse.

Turn on Max DI (CHIRP MEGA SI models only)

Max DI [On] is typically used for deep water to provide the maximum strength for the Down Imaging signal. Max DI [Off] typically provides the best resolution in shallow water.

1. Press the HOME key.
2. Select Settings
3. Select CHIRP Sonar.
4. Under Down Imaging CHIRP, select Max DI.
5. Tap the on/off button, or press the ENTER key, to turn it on.

The instructions in this section apply to the following Humminbird radar models only:

- RH 5
- RH 44
- AS 21RD4KW
- AS 12RD2KW



NOTE: The instructions in this section do not apply to the Humminbird CHIRP radar.

Radar Configuration

The radar should be configured by a qualified radar technician after installation or equipment repair. The settings in this section should only be needed periodically. We recommend that you contact Humminbird Customer Service at 1-800-633-1468 before using the menus in this section.



WARNING! The features in this section affect the performance of the radar and should only be adjusted by a qualified radar technician.



CAUTION! Before the radar settings are adjusted, or before the SOLIX software are updated or restored to system defaults, export the radar installation settings. See **Export Radar Installation Settings**.

Open the Radar Installation Menu

1. Press the HOME key.
2. Select Settings.
3. Select Radar > Installation.

Radar Installation Menu

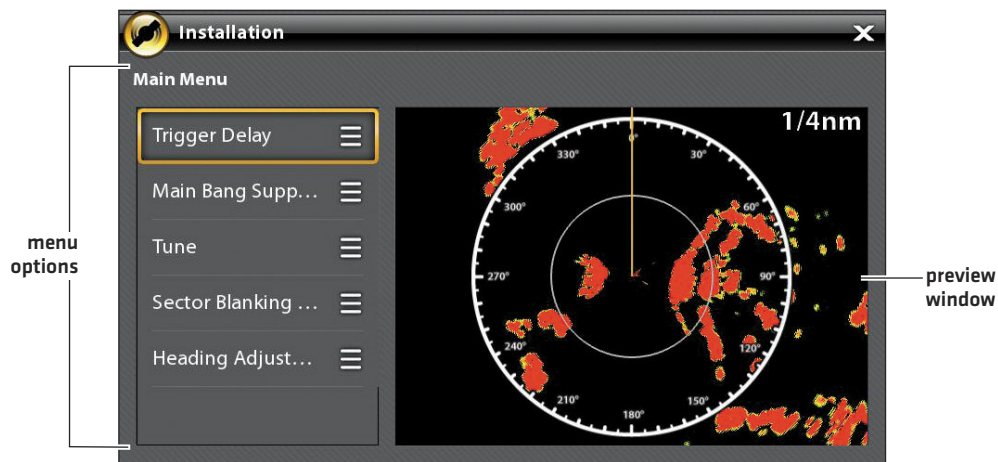

Trigger Delay

Trigger delay adjusts the signal timing so that long straight targets appear straight on the display. The Range and Rain Clutter [FTC] are temporarily adjusted to optimize the system settings. When the Trigger Delay installation setting is completed, the system will return to the previous user settings.

1. Select Trigger Delay from the Installation menu.
2. **Trigger Delay:** Press and hold the slider, or press and hold the ENTER key, to adjust the trigger delay. A high setting sets a longer delay, while a low setting sets the radar to a shorter delay.
3. **Gain:** Turn the Rotary dial to adjust the gain. The gain controls the amplification of the radar signal.
4. **Close:** Tap the Back icon, or press the EXIT key.

Main Bang Suppression

Set the Main Bang Suppression to create a range around the vessel, or the center of the radar pane, where the radar signal will be suppressed. The targets in this range will not be seen.



WARNING! Targets in the Main Bang Suppression Range are not displayed on the Radar View.

1. Select Main Bang Suppression from the Installation menu.
2. **Main Bang Suppression:** Press and hold the slider, or press and hold the ENTER key, to adjust the Main Bang Suppression range. A high setting sets a wider radius around the vessel and scanner, while a low setting limits the radius to a shorter range.
3. You can also adjust the following optional settings:
 - Gain** controls the amplification of the radar signal.
 - Sea Clutter** adjusts the filter that controls the amount of clutter on the view caused by rough sea conditions.
 - Rain Clutter** adjusts the filter that controls the amount of clutter on the view caused by rain or snow.
4. **Close:** Tap the Back icon, or press the EXIT key.

Tune the Radar

The technician can tune the radar automatically [Auto Tune] or enter specific settings manually [Manual Tune]. Tuning is used to optimize the radar system settings. For best results, run the tuning while there are targets within range, so it will be easier to review the data and make adjustments.



WARNING! The radar should only be tuned under very limited circumstances. Contact Humminbird Customer Service at **1-800-633-1468** before tuning the radar.

1. Select Tune from the Installation menu.
2. Select Auto Tune or Manual Tune.
 - Auto Tune:** When you select Auto Tune, the control head stops radar transmission and starts automatic radar tuning.
 - Manual Tune:** Select Coarse Adjustment or Fine Adjustment. Press and hold the slider, or press and hold the ENTER key, to adjust the settings.
3. **Close:** Tap the Back icon, or press the EXIT key.

Setting the Sector Blanking Range



Set the Sector Blanking Range

Sector Blanking sets an area where the radar will not scan. This setting is useful for preventing reflections or false echoes from displaying on the Radar View; however, any targets within this range are not displayed on the screen.

WARNING! Targets in the Sector Blanking Range are not displayed on the Radar View.

1. Select Sector Blanking from the Installation menu.
2. Select Sector Start. Press and hold the slider, or turn the Rotary dial, to set the start of the sector range.
3. Select Confirm. Tap the menu, or press the ENTER key.
4. Select Sector End. Press and hold the slider, or turn the Rotary dial, to set the end of the sector range.
5. Select Confirm. Tap the menu, or press the ENTER key.
6. Tap the Back icon, or press the EXIT key.

Adjust the Heading Line

Use the Heading Line setting to synchronize the on-screen heading with the actual vessel heading so that north is displayed correctly on the view.

1. Select Heading Adjustment from the Installation menu.
2. Press and hold the slider, or turn the Rotary dial, to adjust the heading line.
3. Tap the Back icon, or press the EXIT key.

WARNING! Humminbird is not responsible for the loss of data files [waypoints, routes, tracks, groups, snapshots, recordings, etc.] that may occur due to direct or indirect damage to the unit's hardware or software. It is important to back up your control head's data files periodically. Data files should also be saved to your PC before restoring the unit's defaults or updating the software. See your Humminbird online account at humminbird.com for details.

Export Radar Installation Settings

1. Install a formatted SD card into the SD card slot.
2. Press the HOME key.
3. Select the Files tool.
4. Under Export, select Radar Installation.
5. Select a save location.

Import Radar Installation Settings

1. Install a formatted SD card into the SD card slot.
2. Press the HOME key.
3. Select the Files tool.
4. Under Import, select Radar Installation.
5. Select the radar installation file.

CONFIGURE THE CONTROL HEAD

Use the instructions in this section to review control head and network connections, select baud rates and NMEA 0183 Output sentences, and name the control heads and networks.

When the SOLIX control head equipment and accessories are installed, the Setup Guide provides the prompts to guide you through configuring the unit. When you attach new hardware to the control head after it has been configured, the unit will detect the new hardware and provide additional prompts to add the equipment to the system.

System Info

Review System Connections

Use the System Info dialog box to review control head information such as the software version and serial number. You can also review connection information for the equipment connected to the control head ports, and you can change the control head name.

1. Press the HOME key.
2. Select Settings.
3. Select Network.
4. Select System Info.

The screenshot shows the 'System Info' dialog box with the following fields and values:

Model:	SOLIX 15 SI	Serial Number:	161014220315
Unit Name:	161014220315	IP Address:	169.254.8.241
Software Version:	2.950(1/27/17 16:35)	MAC Address:	74:DA:EA:08:B7:76
Network Name:	NET:161014220315		
Internal GPS:	Not Connected		
NMEA 0183 (1):			
NMEA 0183 (2):			
NMEA 2000:	Not Connected		
Transducer:	Not Configured		
Sonar Temp:	Not Connected		
Speed (Paddle Wheel):	Not Connected		
Aux Temp:	Not Connected		
Master Unit:	Radar		

Below the System Info section is a 'Rename Unit' button with a checkmark icon. At the bottom of the dialog is a status bar with the following data:

Depth	Voltage	Position	Time/Date
45.6 ft	13 V	N 34°12.954' W 83°57.678'	1:40:04 PM 2/3/2017

Callouts in the image point to the following elements:

- control head information (points to Model, Unit Name, Software Version, Serial Number, IP Address, MAC Address)
- network name (points to Network Name)
- control head ports and connection information (points to Internal GPS, NMEA 0183 (1), NMEA 0183 (2), NMEA 2000, Transducer, Sonar Temp, Speed (Paddle Wheel), Aux Temp, Master Unit)
- rename the control head (points to the Rename Unit button)

Change the Control Head Name

When a control head is part of a network, you can change its name so it is easy to identify as a source on the network.

1. From the System Info dialog box [above], select Rename Unit. Use the on-screen keyboard to change the control head name.
2. Select Save.

Sensor Port Connections (GPS and NMEA 0183)

When equipment is connected to the control head, the equipment and its data will be detected automatically. You can also manually select data, set the data offset, baud rate, and NMEA output sentences from the Sensor Port submenus. The available menus are determined by the attached equipment.

1. Press the HOME key.
2. Select Settings.
3. Select Network.
4. Under Sensor Port, select a port menu.

GPS Port: If you've connected an external GPS or an external GPS/Heading Sensor to the control head, select the GPS Port. Use the GPS Port menu options to select the Sensor Type, Data Offset, and Pitch and Roll installation.

NMEA 0183 [1] and [2] allow you to change the data for Sensor Type, Data Offset, Baud Rate, and NMEA Output.

Sensor Type	Auto-Select is turned on as the default setting, and the available data from the attached sensor will be auto-selected with a check mark. To change the selected data, turn off Auto-Select, and manually change the data by adding or removing a check mark. [check mark = selected]
Data Offset	To adjust the zero point of the attached sensor, select Data Offsets. Depending on the attached sensor, you can adjust the Depth Offset, Temperature Offset, Heading Adjustment, and STW [Speed Through Water] Calibration from this menu. For example, select Depth Offset to adjust the digital depth readout to indicate the depth from the waterline or the boat's keel for the selected sensor.
Baud Rate	Select a baud rate for the selected port. [Auto, 4800, 9600, 38400; Default = Auto]
NMEA Output	Select NMEA Output sentences for the selected port. See the NMEA 0183 table on the following pages.



NOTE: To set up a NMEA 2000 network, see **Set up a NMEA 2000 Network**.

NMEA 0183

Message	Description	Input	Output
AAM	Waypoint Arrival Alarm		•
APB	Heading/Track Controller [Autopilot] Sentence "B"		•
BOD	Bearing-Origin to Destination		•
BWC	Bearing & Distance to Waypoint - Great Circle		•
BWR	Bearing & Distance to Waypoint - Rhumb Line		•
DBT	Depth Below Transducer	•	•
DPT	Depth	•	•
GGA	Global Positioning System Fix Data	•	•
GLL	Geographical Position - Latitude/Longitude	•	•
GNS	GNSS Fix Data	•	•
GSA	GNSS DOP and Active Satellites	•	•
GSV	GNSS Satellites In View	•	•
HDG	Heading, Deviation & Variation	•	•
HDM	Heading, Magnetic	•	•
HDT	Heading, True	•	
MTW	Water Temperature	•	•
MWD	Wind Direction & Speed	•	
MWV	Wind Speed & Angle	•	
RMB	Recommended Minimum Navigation Information		•
RMC	Recommended Minimum Specification GNSS Data	•	•
ROT	Rate of Turn	•	•
VBW	Dual Ground/Water Speed	•	
VDM	AIS VHD Data Link [Other Vessels]	•	
VDO	AIS VHD Data Link [Own Vessel]	•	
VHW	Water Speed and Heading	•	•
VTG	Track Made Good & Ground Speed		•
XDR	Transducer Measurements	•	
XTE	Cross-Track Error, Measured		•
ZDA	Time & Date	•	•

Configure the NMEA Talker ID

Use the following instructions to change the NMEA 0183 Talker ID to match the NMEA 0183 installed accessory.

1. Press the HOME key.
2. Select Settings > Network.
3. Under Sensor Port, select a NMEA port menu.
4. Select NMEA Output.
5. Under Configure NMEA Talker ID, select IN-Integrated Navigation [Default] or GP-Global Positioning System.

Set up Autopilot

If you are using a separate-purchase Humminbird autopilot [SC 110] with the SOLIX control head, it is important to review the following:

- Read the autopilot manual completely so you understand the installation and operation requirements before you use the equipment.
- There are many safety precautions that must be considered before you use the equipment. See the autopilot manual for more information.
- When you initiate navigation from the control head, there are certain controls that are NOT available on the autopilot. See the autopilot manual for more information.



WARNING! The autopilot system should be installed and configured by a Certified Marine Electronics Technician [CMET] or an authorized Marine Electronics Installer [MEI]. See NMEA.org for details. Incorrect installation may affect the system's performance, which affects the safety of the vessel and its passengers. Refer to the installation guide included with the autopilot. If you have questions about the installation, please contact Humminbird Customer Service.

Set up Autopilot

Use the following instructions to set up Autopilot on the SOLIX control head.

1. Select the control head that has the autopilot connected to it.
2. Press the HOME key.
3. Select Settings.
4. Select Network.
5. Under Sensor Port, select the port that is connected to the autopilot [NMEA 0183 [1], or NMEA 0183 [2]].
6. Select NMEA Output. Tap the on/off button, or press the ENTER key, to turn it on.
7. Under AutoPilot, select APB. Tap the check box, or press the ENTER key, to add a check mark to it.
8. To enable all modes of the SC 110 with the SOLIX control head, select the NMEA Output sentences as shown in the following table.

Multisensor	RMC or VTG
Standby	n/a
Auto	n/a
Auto-Track	GGA or GLL or RMC
Nav	APA or APB or BOD + RMB or BOD + XTE or BOD + XTR
Wind	MWV or VWR



NOTE: See the SC 110 manual and the SCP 110 manual for details. To download the manuals, visit our Web site at humminbird.com.

9. Press the EXIT key to return the previous menu.
10. Select Baud Rate. Select 4800.
11. Go to the Autopilot section of this manual to enable autopilot navigation with the control head.

SET UP A NMEA 2000 NETWORK

Use the instructions in this section if a NMEA 2000 network is connected to the control head.

When equipment is connected to the control head, the equipment and its data will be detected automatically. You can also manually select equipment and set the data offset. The available menus are determined by the attached equipment.



NOTE: Humminbird recommends that the NMEA 2000 network be installed by a certified NMEA 2000 technician. See NMEA.org for details.

Preparation

The NMEA 2000 network connects to the NMEA 2000 port on one control head. If you have a multi-control head network, select the control head that is connected to the NMEA 2000 network backbone to proceed with the following instructions.

Open the NMEA 2000 Sensor Port Menu

1. Press the HOME key.
2. Select Settings.
3. Select Network.
4. Under Sensor Port, select NMEA 2000.

Turn on the NMEA 2000 Network

1. From the NMEA 2000 Sensor port menu, select NMEA 2000 Network.
2. Tap the on/off button, or press the ENTER key, to turn it on.

Select NMEA 2000 Devices Manually (optional)

When equipment is connected to the control head, the equipment and its data will be detected automatically. Use the instructions in this section to manually select devices to use on the NMEA 2000 network. See the illustrations on the following pages.

1. From the NMEA 2000 Sensor port menu, select NMEA 2000 Devices.
2. Select Auto-Select. Tap the on/off button, or press the ENTER key, to turn it off.
3. Select devices to add to the NMEA 2000 network. [check mark = included, blank = not included]

NMEA 2000 Network Devices Selected Manually

The screenshot shows the 'NMEA 2000 Devices' settings page with 'Auto-Select' turned off. The left sidebar is under 'Settings' with 'Network' selected. The main content area shows the unit 'SOLIX 15 SI - 161014220315' and a list of devices: GH2183 (checked), WSO100 (checked), DST100 (unchecked), and TLM100 (unchecked). Annotations point to the 'Auto-Select' toggle and the checkboxes for each device.

Device	Status
GH2183	Selected (checked)
WSO100	Selected (checked)
DST100	Detected but not selected (unchecked)
TLM100	Detected but not selected (unchecked)

NMEA 2000 Network Devices Selected Automatically

The screenshot shows the 'NMEA 2000 Devices' settings page with 'Auto-Select' turned on. The left sidebar is under 'Home' with 'Network' selected. The main content area shows the unit 'SOLIX 15 SI - 161014220315' and a list of devices: GH2183 (checked), WSO100 (checked), DST100 (checked), and TLM100 (checked). Annotations point to the 'Auto-Select' toggle and the checkboxes for each device.

Device	Status
GH2183	Detected and selected (checked)
WSO100	Detected and selected (checked)
DST100	Detected and selected (checked)
TLM100	Detected and selected (checked)

Set NMEA 2000 Data Offsets

1. From the NMEA 2000 Sensor port menu, select Data Offsets.
2. Select a device.
3. Tap the on/off slider, or press the ENTER key, to turn it off.
4. Press and hold the slider, or press and hold the ENTER key, to set the offset amount.

NMEA 2000 Data Offset

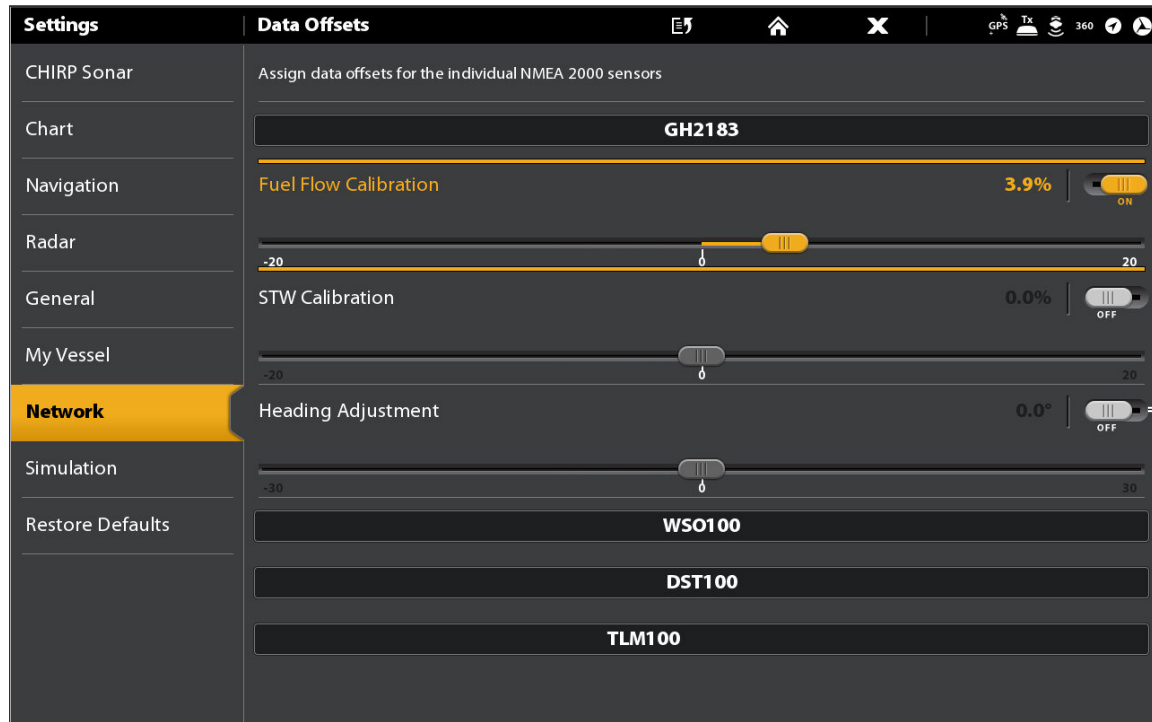

Turn off the slider to manually adjust the data offset.

NMEA 2000 Messages (PGN)

The following NMEA 2000 input/output messages are available when NMEA 2000 is turned on and the related NMEA 2000 equipment is detected and selected as a source.

Message (PGN)	Description	Input	Output
059392	ISO Acknowledgement	•	•
059904	ISO Request	•	•
060928	ISO Address Claim	•	•
126208	NMEA - Command/Request/Acknowledge Function	•	•
126464	Receive/Transmit PGN List Group Function	•	•
126992	System Time	•	
126996	Product Information	•	•
127245	Rudder	•	
127250	Vessel Heading	•	
127251	Rate of Turn	•	
127488	Engine Parameters, Rapid Update	•	
127489	Engine Parameters - Dynamic	•	
127497	Trip Parameters, Engine	•	
127505	Fluid Level	•	
128267	Water Depth	•	
129026	COG & SOG, Rapid Update	•	
129029	GNSS Position Data	•	
129033	Time & Date	•	
129283	Cross Track Error	•	
129284	Navigation Data	•	
129285	Navigation - Route/WP Information	•	
129539	GNSS DOPs	•	
129540	GNSS Sats in View	•	
130052	Loran C TD Data	•	
130306	Wind Data	•	
130310	Environmental Parameters	•	
130311	Environmental Parameters	•	
130312	Temperature	•	
130313	Humidity	•	
130314	Actual Pressure	•	
130576	Small Craft Status	•	

NMEA 2000 AIS Messages (PGN)

The following NMEA 2000 input/output messages are available when NMEA 2000 is turned on and an AIS is detected and selected as a source on the NMEA 2000 network.

Message (PGN)	Description	Input	Output
129038	Class A Position Report	.	
129039	Class B Position Report	.	
129809	AIS Class B Static Data, Part A	.	
129810	AIS Class B Static Data, Part B	.	

Set up NMEA 2000 Engine Sources

When a NMEA 2000 Engine is connected to the NMEA 2000 network, it is detected by the control head. The control head will provide prompts to set up engines in the system. The control head assigns a number to each engine. The sources are numbered lowest to highest, where 0 [zero] is the lowest and first source identified. You can use the sources identified by the control head, or you can manually assign an engine to each source number.

For example, Engine 1 reports data from the engine identified as the number 0 Instance in installation [typically the engine located on the port side of the boat towards the bow], and Engine 2 is the engine identified as the number 1 instance in installation [typically the engine located on the starboard side of the boat towards the keel].



NOTE: See **Views: Set up an Instrument View** to set up the instrument views for your engine data.

Set up the Number of Engines

The number of engines and tanks are entered using the Setup Guide during initial installation. Use the instructions in this section to change the number of engines and tanks displayed on the control head.

1. Press the HOME key.
2. Select Settings.
3. Select My Vessel.
4. Select Engines/Tanks.
5. Select the total number of engines and fuel tanks on your boat.

Engine 1 Source Auto-Configured

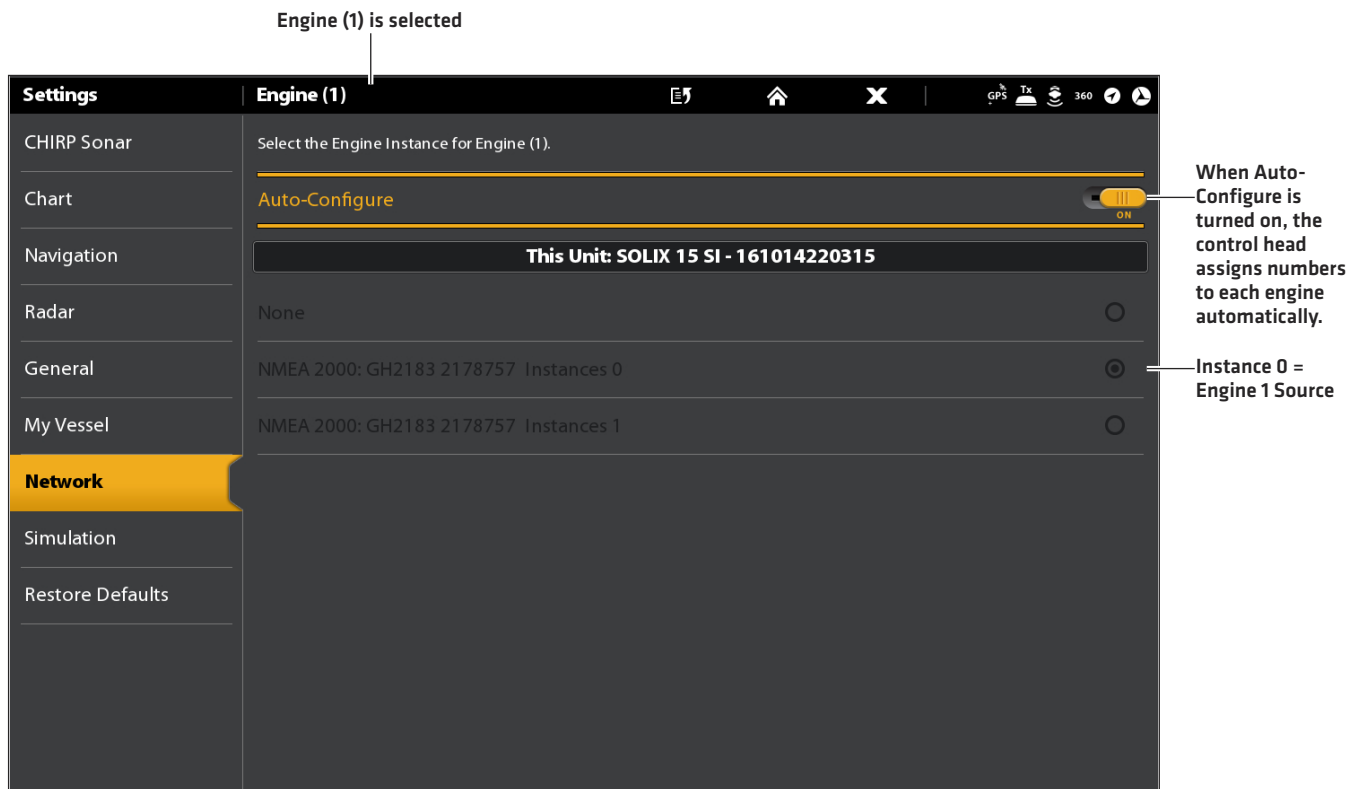

Change the Engine Source Assignments

The instructions in this section are optional and allow you to change which engine is assigned as the Engine 1, Engine 2, or Engine 3 source in the control head.

1. Press the HOME key.
2. Select Settings.
3. Select Network.
4. Select Data Sources.
5. Under Engine Data, select Engine 1, Engine 2, or Engine 3.
6. Turn off Auto-Configure.
7. Select an Engine from the list.

Set up Fuel Tanks

The Setup Guide provides prompts to set up the fuel tanks in the system, and it assigns a source number to each fuel tank. If a NMEA 2000 fuel tank sensor and a fuel flow rate sensor are installed, the control head can display fuel levels automatically. If only a fuel flow rate sensor is installed, you need to set up the fuel tanks manually to manage fuel levels.

Set up the Number of Tanks

The number of engines and tanks are entered using the Setup Guide during initial installation. Use the instructions in this section to change the number of engines and tanks displayed on the control head.

1. Press the HOME key.
2. Select Settings.
3. Select My Vessel.
4. Select Engines/Tanks.
5. Select the total number of engines and fuel tanks on your boat.

If you do not have a NMEA 2000 fuel tank sensor, proceed to **Set the Fuel Tank Capacity**.

Set the Fuel Tank Capacity

If there is a fuel flow rate sensor installed, but not a NMEA 2000 fuel tank sensor, use the instructions in this section to set up fuel tank data manually. You can also use these instructions to confirm Automatic Fuel Management Mode if you have a NMEA 2000 fuel tank sensor and a fuel flow rate sensor installed.

1. Set up the number of fuel tanks on the boat. See **Set up the Number of Tanks**.
2. Press the HOME key.
3. Select the Fuel tool.
4. Select Settings.
5. Select Manual.



NOTE: If NMEA 2000 fuel tank sensor and a fuel flow rate sensor are installed, select Auto to automatically detect the tank capacity.

6. Select Fuel Capacity.
7. Use the on-screen keyboard to enter the total fuel capacity of the tank.

If there is more than one tank on the boat, indicate the total amount of fuel from all tanks.

8. Select Save.

Setting up Fuel Tanks Manually

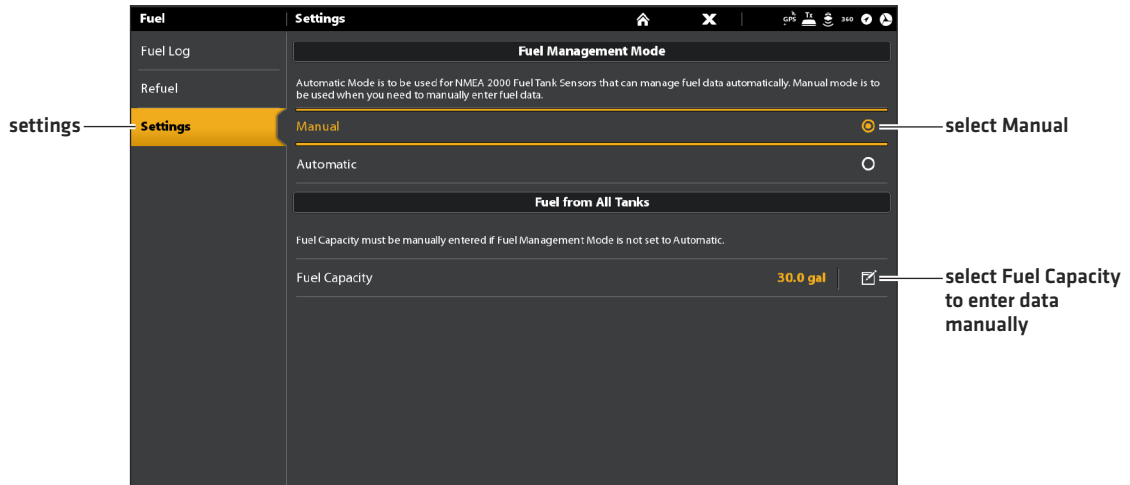

Displaying the Fuel Tool

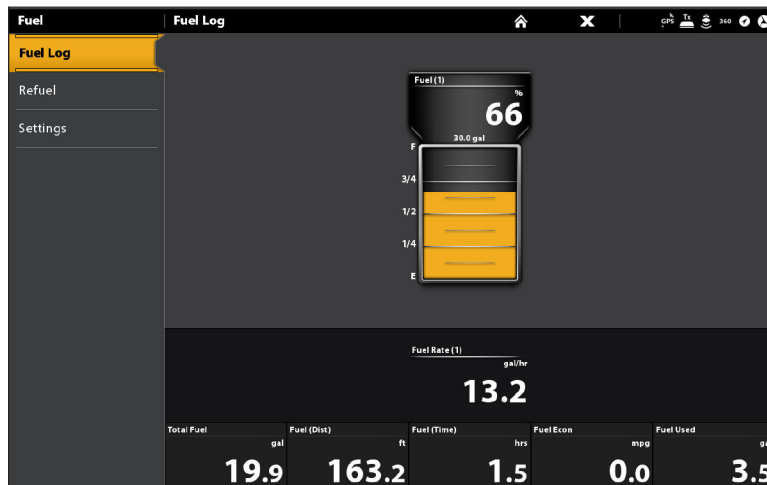

Open the Fuel Tool

1. Press the HOME key.
2. Select the Fuel tool.

Refill the Tank(s)

The menu options in this section are determined by the Fuel Management Mode [Manual or Automatic]. See **Set the Fuel Tank Capacity** for more information.

1. Open the Fuel tool, and select Refuel.
2. **To fill the tank to the top**, select Fill Up or Reset Fuel Used.

To add an amount to the tank, select Add Fuel. Use the on-screen keyboard to enter the amount and save it.

Change the Fuel Tank or Fuel Flow Source Assignments

The instructions in this section are optional and allow you to change which fuel tank is assigned as the Tank 1, Tank 2, or Tank 3 source in the control head. You can also use these instructions to change the fuel flow rate Sensors (Fuel Flow) assignments. The menu options are determined by the type of sensors installed.

1. Press the HOME key.
2. Select Settings.
3. Select Network.
4. Select Data Sources.
5. Under Fuel Data, select Tank 1, Tank 2, or Tank 3.
If fuel flow rate sensors are installed, select Fuel Flow - Engine 1, 2, or 3.
6. Turn off Auto-Configure.
7. Select a fuel tank from the list.

SET UP YOUR HUMMINBIRD NETWORK

When the Humminbird network is fully installed, configure the network so the control heads and equipment are synchronized across the network. Depending on your network configuration, your options may include sources from remote control head(s), NMEA 0183, Ethernet, and NMEA 2000.

Use the instructions in this section to complete the following network setup requirements:

1. Configure a new network.
2. Select transducers from the network.
3. Change GPS sources.
4. Select data sources.
5. Set vessel display settings.

Understand Global

When you configure a new network, the control heads are synchronized. Settings such as alarms, map sources, favorite views, preferences, overlays, sonar sources, and GPS sources are shared across control heads.

Many menu settings include the Global on/off button. **When Global is turned on**, the selected menu setting on the control head is shared with the other control heads in the network.

When Global is turned off, the selected menu setting is only available on the selected control head.

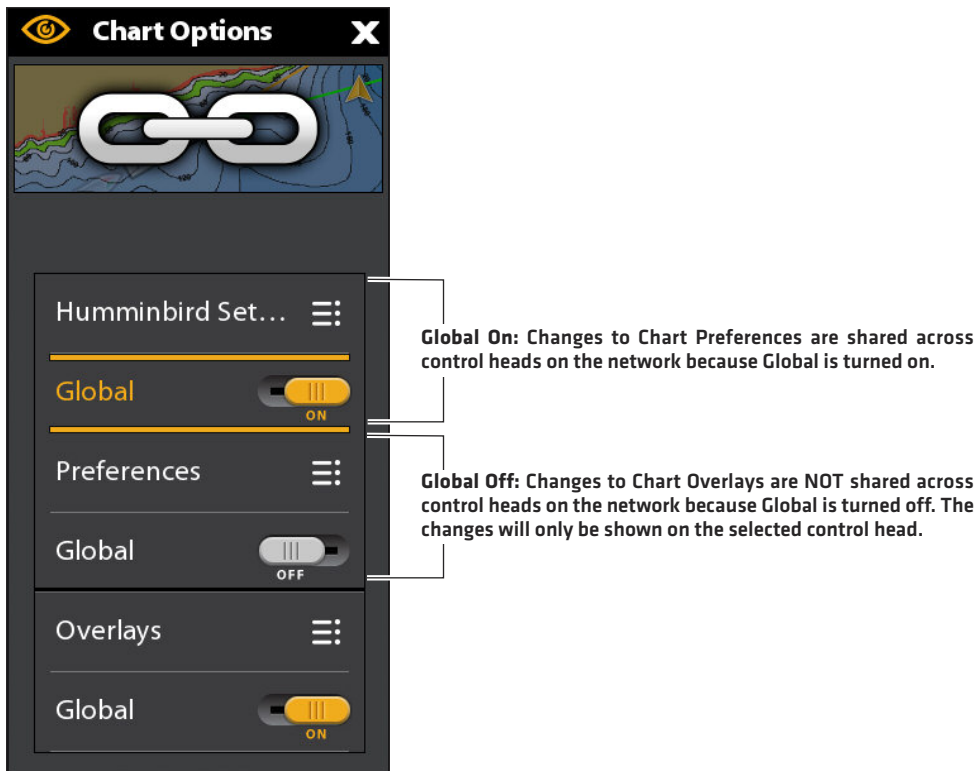

Understand Auto-Configure

When you configure the control head network, the control head automatically selects a source for each category. For example, if there are multiple heading sensors attached, the control head will choose one sensor to provide the heading. If you prefer a different sensor to provide the heading, you can manually select a different heading sensor.

The Auto-Configure on/off button is displayed in each source category. **When Auto-Configure is turned on**, the sources are selected automatically by the control head. **When Auto-Configure is turned off**, you can select sources based on your preferences.

1 | Configure a New Network

Use the instructions in this section if you have more than one Humminbird control head connected to the network. Configuring the network synchronizes the control head settings.

If there is only one control head on the network, skip this section. Proceed to section 2: *Select Sonar Sources*.

Preparation

1. Confirm all control heads and network equipment are powered on.
2. Designate one control head as the main control head. Ideally, you've used the main control head, and it has been set up with your favorite view settings, menu preferences, and more. The other control heads in the network will synchronize to the main control head.

If this is a first-time configuration for all control heads, no additional actions are required. Proceed to *Configure the Network*.

3. **Global:** If there are any settings you'd like to keep on a control head, and not share globally, make sure the Global menu on that setting is turned off.
4. **Navigation data:** navigation data will be synchronized. To export navigation data from a control head and save it, export the data to an SD card. See *Manage your Navigation Data*.
5. **Export Menu Settings:** When control heads are synchronized to a main unit, their menu settings are changed to match the main unit. To save menu settings from a selected remote control head, export the menu settings to an SD card (see *Update Software*).

Configure the Network

1. On the main control head, press the HOME key.
2. Select Settings.
3. Select Network.
4. Select Configure New Network.
5. Select Sync Network.

2 | Select Sonar Sources

When a transducer is first connected to the control head or network (through black box sonar or additional Humminbird control heads), it will be detected by all control heads in the network. The SOLIX control head selects the transducer connected to it as the primary sonar source. The SOLIX control head is compatible with black box sonar to expand its sonar capabilities. See humminbird.com for transducer configuration options.



NOTE: Humminbird has provided the best settings for your unit. You can use the settings included with your control head, or you can adjust these advanced options.

Open the Sonar Source Menu

1. Press the HOME key.
2. Select Settings.
3. Select Sonar.
4. Select Sonar Source.

Sonar Source Overview

When the network is configured, you can select any transducer from the network to provide the sonar data on the control head. The sonar sources can be shared between control heads or you can use individual sonar sources on each control head.

The transducer you select on the 2D Sonar tab will provide the data for the 2D Sonar Views and related digital readouts.

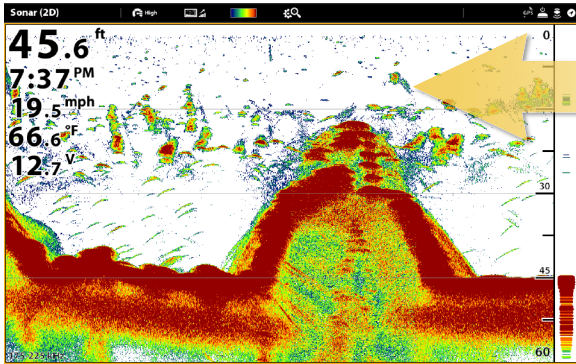

The 'Sonar Source Select' menu is shown with the '2D Sonar' tab selected. It lists four options: 2D Sonar, Down Imaging, Side Imaging, and 360 Imaging. Each option has a radio button, a transducer icon, a ping setting, and a transducer setting. The '2D Sonar' option is selected, and its settings are: SOLIX 12 SI, MED/HIGH ping, and 2D + DI + SI transducer setting.

Option	2D Source	2D Pinging	Transducer Setting
2D Sonar	<input checked="" type="radio"/> SOLIX 12 SI	MED/HIGH ON	2D + DI + SI ON
Down Imaging	<input type="radio"/> SOLIX 12 SI	MED/HIGH ON	2D + DI + SI ON
Side Imaging	<input type="radio"/> SOLIX 12 SI	MED/HIGH ON	2D + DI + SI ON
360 Imaging	<input type="radio"/> 360 Imaging 150712227777	455/800 OFF	ON

The transducer you select on the Down Imaging tab will provide the data for the Down Imaging Views and related digital readouts.

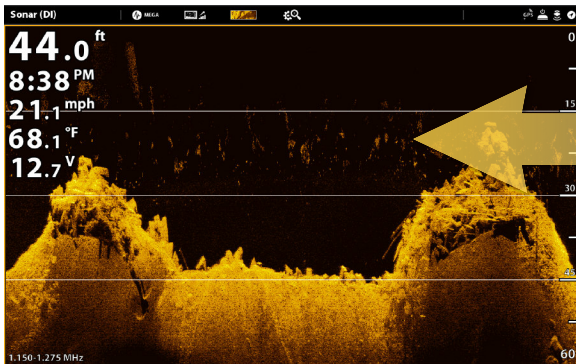

The 'Sonar Source Select' menu is shown with the 'Down Imaging' tab selected. It lists four options: 2D Sonar, Down Imaging, Side Imaging, and 360 Imaging. The 'Down Imaging' option is selected, and its settings are: SOLIX 12 SI, 455/800/MEGA ping, and 2D + DI + SI transducer setting.

Option	DI Source	DI Pinging	Transducer Setting
2D Sonar	<input type="radio"/> SOLIX 12 SI	455/800 ON	2D + DI + SI ON
Down Imaging	<input checked="" type="radio"/> SOLIX 12 SI	455/800/MEGA ON	2D + DI + SI ON
Side Imaging	<input type="radio"/> SOLIX 12 SI	455/800/MEGA ON	2D + DI + SI ON
360 Imaging	<input type="radio"/> 360 Imaging 150712227777	455/800 OFF	ON

The transducer you select on the Side Imaging tab will provide the data for the Side Imaging Views and related digital readouts.

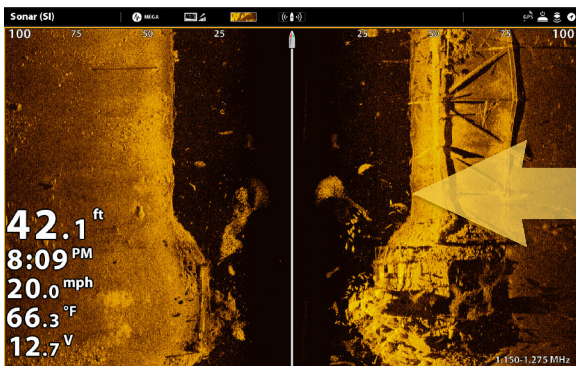

The 'Sonar Source Select' menu is shown with the 'Side Imaging' tab selected. It lists four options: 2D Sonar, Down Imaging, Side Imaging, and 360 Imaging. The 'Side Imaging' option is selected, and its settings are: SOLIX 12 SI, 455/800/MEGA ping, and 2D + DI + SI transducer setting.

Option	SI Source	SI Pinging	Transducer Setting
2D Sonar	<input type="radio"/> SOLIX 12 SI	455/800 ON	2D + DI + SI ON
Down Imaging	<input type="radio"/> SOLIX 12 SI	455/800 ON	2D + DI + SI ON
Side Imaging	<input checked="" type="radio"/> SOLIX 12 SI	455/800/MEGA ON	2D + DI + SI ON
360 Imaging	<input type="radio"/> 360 Imaging 150712227777	455/800 OFF	ON

Select Sonar Sources

Use the instructions in this section to assign sonar sources to each control head. The sonar sources can be shared between control heads or you can use different sonar sources on each control head.

- From the Sonar Source Menu, select the first tab. In the following illustration, the first tab is 2D.

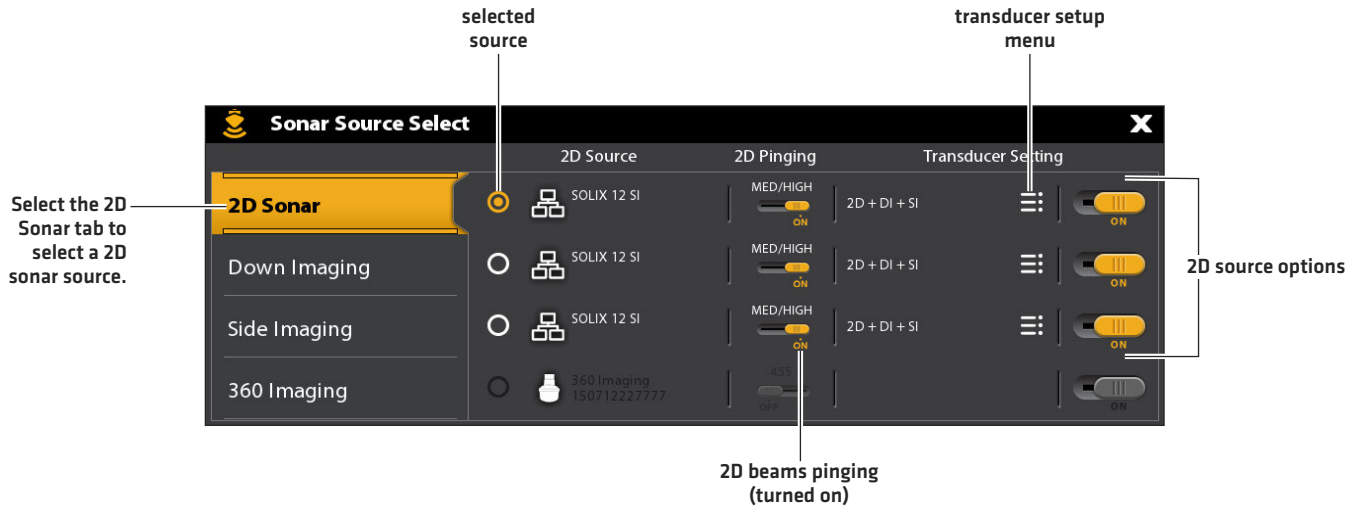

- Select the transducer connection location. The connection locations are displayed as follows:



Selected Control Head [Local]: the control head you are actively using



Remote Control Head: additional control heads connected to the network



Black Box Sonar

- Repeat steps 1 and 2 for each tab. You can select one sonar source on each tab.



NOTE: The list is determined by the connected equipment on the network and the transducer type. DualBeam PLUS sonar sources will only be displayed on the 2D tab, Down Imaging sources will only be displayed on the Down Imaging tab, etc.



NOTE: If you have installed an accessory transducer, and it is not displayed in the transducer list, see **Installation Information: Set up or Change Transducer Settings**.

When you turn on/off pinging or change the transducer settings, all control heads sharing the transducer are affected.

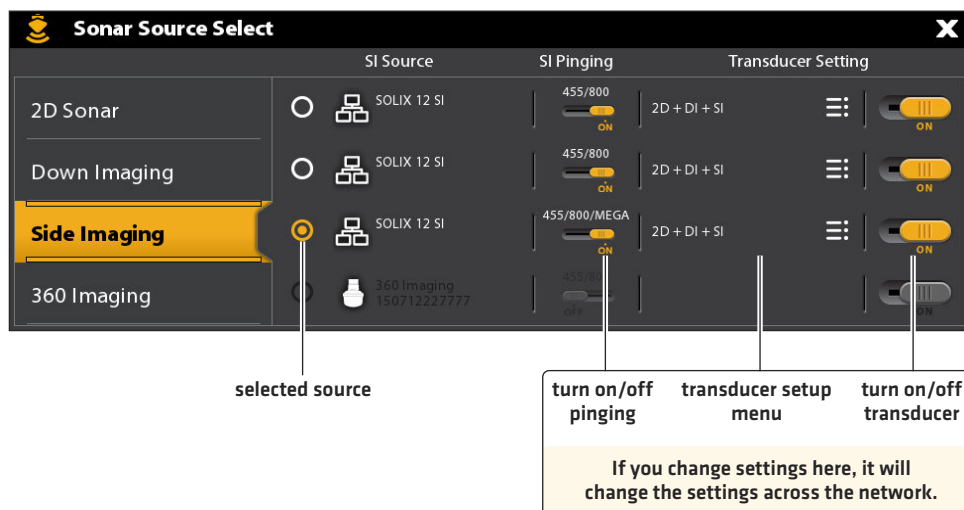

3 | Select GPS Sources (optional)

The SOLIX control head defaults to the internal GPS receiver as the primary source [GPS [1]]. If you connect an external GPS receiver to the control head, it will be assigned as the secondary source GPS [2].

If you connect an external GPS receiver to the control head, it will be assigned as the primary source GPS [1].

GPS [1] provides position data, Speed over Ground (SOG), Course over Ground (COG), waypoints, routes, tracks, and navigation calculations to the control head.

GPS [2] provides position data that is displayed in the GPS [2] data box.

You can also manually change which GPS receiver is the selected source for GPS [1] or GPS [2]. For example, if you've connected an external GPS receiver to the SOLIX control head, you can assign it to GPS [1], so the control head will use it as the primary source [instead of the internal GPS receiver]. If the control head is part of an Ethernet or NMEA 2000 network, you can also select the GPS receivers from the network.

Open the GPS Tool

1. Press the HOME key.
2. Select the GPS tool.

Select GPS Sources Automatically

1. Under GPS Source, select GPS [1] or GPS [2].
2. Select Auto-Configure. Tap the on/off button, or press the ENTER key, to turn it on.

Select GPS Sources Manually

Use the instructions in this section to manually select a GPS source.

1. Under GPS Source, select GPS [1] or GPS [2].
2. Select Auto-Configure. Tap the on/off button, or press the ENTER key, to turn it off.
3. Select a GPS receiver from the list.

Share GPS Sources with the Network

1. Under GPS Source, select Global Source.
2. Tap the on/off button, or press the ENTER key, to turn it on.



NOTE: See **Set up your Humminbird Network** for details about Global On/Off.

4 | Select Data Sources [optional]

When the network has been configured, you can choose sources from the entire network. Depending on your network configuration, your options may include sources from remote control head(s), NMEA 0183, Ethernet, and NMEA 2000. Sources are shared across the network. In some situations, sources can be individualized for each control head. For example, Control Head A can use one transducer and Control Head B can use a different transducer.

Auto-Configure: The Auto-Configure on/off button is displayed in each source category. When Auto-Configure is turned on, the sources are selected automatically by the control head. When Auto-Configure is turned off, you can select sources based on your preferences.

For example, if there are multiple heading sensors attached, the control head network will choose one sensor to provide the heading. If you prefer a different sensor to provide the heading, you can manually assign a different heading sensor as the selected source.

Select Sources Automatically (default)

Auto-Configure is turned on by default, so the instructions in this section are only necessary if you've manually changed the source selection and want to return to a source being chosen automatically.

1. Press the HOME key.
2. Select Settings.
3. Select Network.
4. Select Data Sources.
5. Select a Data Category, and select the data type under that category.
6. Select Auto-Configure. Tap the on/off button, or press the ENTER key, to turn it on.

Select Sources Manually (optional)

Use the instructions in this section to manually select a source.

1. Press the HOME key.
2. Select Settings.
3. Select Network.
4. Select Data Sources.
5. Select a Data Category, and select the data type under that category.
6. Select Auto-Configure. Tap the on/off button, or press the ENTER key, to turn it off.
7. Select a source from the list.

CHANGE THE NETWORK NAME

The Network Info menu allows you to name each network so it is easy to identify in the system. You can also review network information from the dialog box.

1. Press the HOME key.
2. Select Settings.
3. Select Network.
4. Select Network Info.
5. Select Rename Network. Use the on-screen keyboard to change the control head name.
6. Select Save.

Manually Selecting a Source for Temp (1)

Temp (1) is selected

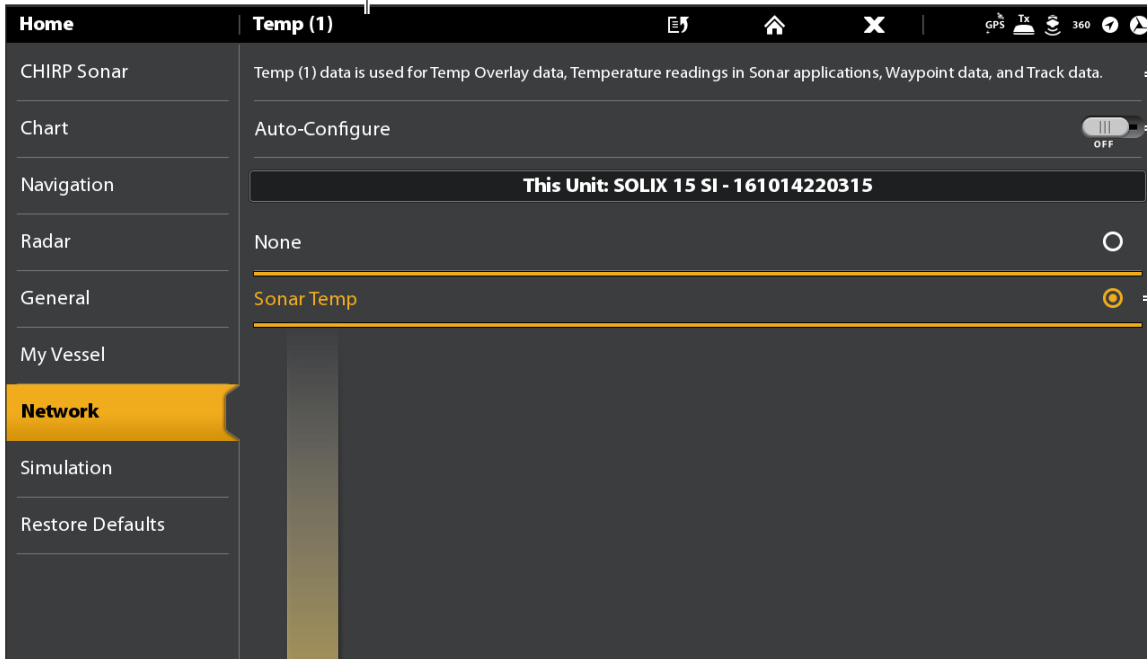

The sources you select will provide the data for the related digital readouts and more, depending on your selection. In the illustration above, see *Information about the Selected Source*.

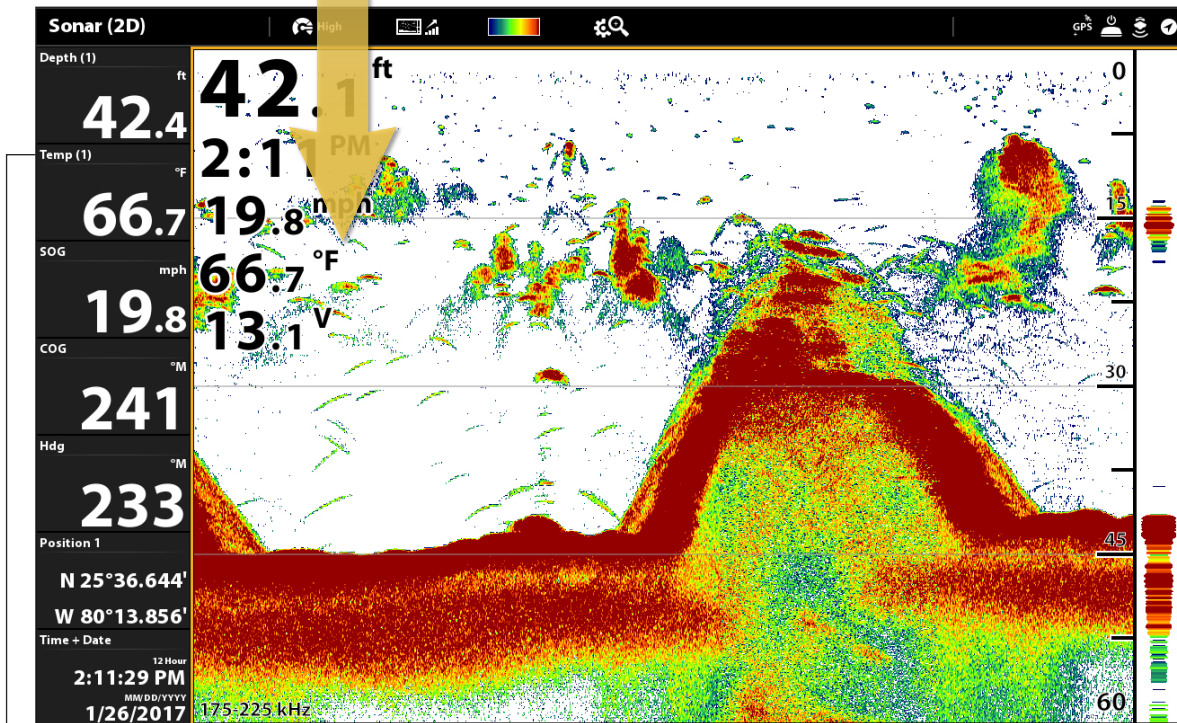

The Temp 1 digital readout data is provided by the Temp (1) source.

MANAGE YOUR CONTROL HEAD

Many of the control head settings can be accessed from the Settings tool [General Menu] or from the Power X-Press Menu in the status bar.

Open the Settings Tool

1. Press the HOME key.
2. Select Settings.
3. Select General.

Open the Power X-Press Menu

Many of the control head settings can be accessed quickly from the Power X-Press Menu. You can also turn off Radar transmission or change the transducer source from this menu.

1. Tap the top, right corner of the status bar.

OR

Press the POWER key.

Adjust Lighting

The lighting menus can be accessed from the Settings tool [General Menu] or the Power X-Press Menu. The following instructions use the Power X-Press Menu.

Adjust the Backlight

1. Open the Power X-Press Menu.
2. Select Backlight.
3. Press and hold the slider, or turn the Rotary dial, to adjust the setting.

Turn on/off Night Mode

1. Open the Power X-Press Menu.
2. Select Night Mode.
3. Tap the on/off button, or press the ENTER key.

Change Touch Screen and Key Sounds

Turn on/off Touch Screen

1. Press the POWER key twice.

OR

1. Open the Power X-Press Menu.
2. Select Touch Screen.
3. Tap the on/off button, or press the ENTER key.

Turn on/off Key Sounds

1. Press the HOME key.
2. Select Settings.
3. Select General.
4. Select Key Sounds.
5. Tap the on/off button, or press the ENTER key.

Import/Export Files

It is important to back up your data files periodically. Data files should also be saved to your PC before restoring the unit's defaults or updating software.



WARNING! Humminbird is not responsible for the loss of data files (waypoints, routes, tracks, groups, snapshots, recordings, etc.) that may occur due to direct or indirect damage to the unit's hardware or software. It is important to back up your control head's data files periodically. Data files should also be saved to your PC before restoring the unit's defaults or updating the software. See your Humminbird online account at humminbird.com for details.

Use the following instructions to save your menu settings. To import or export navigation data, see *Manage your Navigation Data*. To export your Radar installation settings, see *Installation Information: Configure Humminbird Radar*.

Import Files

1. Install the SD card with the files into the control head port.
2. Press the HOME key.
3. Select the Files tool.
4. Under Import, select Menu Settings.
5. Follow the on-screen prompts to select a file and import it.

Export Files

1. Install the SD card with the files into the control head port.
2. Press the HOME key.
3. Select the Files tool.
4. Under Export, select Menu Settings.
5. Follow the on-screen prompts.
6. **Select a Save Location:** Select the port where the SD card is installed.

UPDATE SOFTWARE

As you build your Humminbird network, it is important to keep your control head and accessories software up to date. Accessories such as i-Pilot Link, 360 Imaging, SM3000 (Sonar Black Box), and Ethernet Switches are updated through the SOLIX control heads.

The Software Update Guide can be downloaded from your online account at humminbird.com. If you have questions about the software update process, contact Humminbird Customer Service.

Preparation: We recommend that you read this section completely before starting any software updates. Control heads take approximately 10 minutes to update, and each control head on the network must be updated individually. Accessories take approximately 3 minutes to update.

Supplies: In addition to your Humminbird equipment, you will need a PC with Internet access and a blank SD card.

1 | Register Products and Back up Data

Before the control head software is updated or restored to system defaults, export your menu settings, radar settings, and navigation data, and copy your screen snapshots to an SD card.

⚠ WARNING! Humminbird is not responsible for the loss of data files (waypoints, routes, tracks, groups, snapshots, recordings, etc.) that may occur due to direct or indirect damage to the unit's hardware or software. It is important to back up your control head's data files periodically. Data files should also be saved to your PC before restoring the unit's defaults or updating the software.

Register your Humminbird Products

Set up an online account and register your Humminbird equipment so that you will receive the latest Humminbird news, including accessory compatibility and software update information.

1. Go to our Web site at humminbird.com. Select Support > Register your Product.
If you already have a humminbird.com account, select My Humminbird.
2. Follow the on-screen prompts to create a new account and register your products.

Export Data and Menu Settings

It is important to back up your control head data files and menu settings. Use the instructions in this section before you restore the control head defaults or update software.

1. Install the SD card into the control head card slot.
2. Press the HOME key.
3. Select the Files tool.
4. Under Export, select Nav Data.
5. Follow the on-screen prompts.
6. **Select a Save Location:** Save to the SD Card (left slot = SD Card 1, right slot = SD Card 2).
7. Repeat steps 4 and 5 to export Menu Settings and Radar Installation settings (if applicable to your installation).
8. Repeat the steps in this section on each control head.

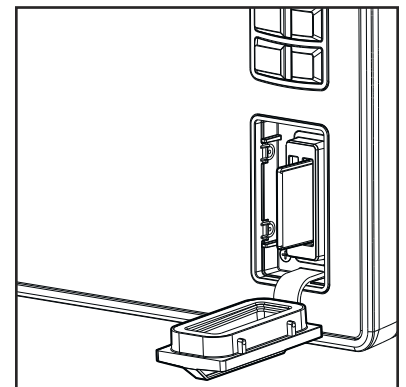

Insert the SD card with the label facing left

📄 NOTE: If you want to use the data files and menu settings on your control head after it has been updated, you can import them from the Files tool.

Copy Internal Images

If you have screen snapshots saved to the control head, use the following instructions to copy them to an SD card.

1. Install the SD card into the control head card slot.
2. Press the HOME key.
3. Select the Images tool.
4. Under Source, select Internal.
5. Press and hold one of the screen snapshots.

OR

Use the Joystick to select a screen snapshot. Press the MENU key.

6. Select Copy All.
7. **Select a Save Location:** Save to the SD Card [left slot = SD Card 1, right slot = SD Card 2].
8. Repeat the steps in this section on each control head.

2 | Check the Current Software Version

It is helpful to review the software version number that is currently installed on the control head and each accessory.

1. Press the HOME key.
2. Select Setting > Network > Network Info.
3. The Network Info dialog box shows a section for each device connected to the network. Scroll to each section to note the software version number listed.

3 | Download Software Updates

1. Install the SD card into the PC card slot.
2. Go to humminbird.com, and select My Humminbird to sign in to your account.
3. Select the My Equipment tab. The available software updates are listed as **Downloads** under each registered product.
 - Under Downloads, click the file name.
 - Read the instructions in the dialog box and select Download.
 - Follow the on-screen prompts to save the software file to the SD card.
4. Repeat step 3 to download the software updates posted to each registered product.

4 | Update Control Head Software

When you install the SD card with the software file, the control head will detect the update and provide an automatic prompt to install the software. You can follow the prompts or choose to install the software at a later time through the Files tool. It is important to review the following tips:

- **Automatic Restart:** The control head will restart during the software update process.
- **Multiple Control Heads:** If you have more than one control head on the network, go to each control head to install the latest software update. Control Head software updates cannot be updated through another networked unit.



WARNING! Before the control head software is updated or restored to system defaults, export your menu settings, radar settings, and navigation data. Copy your screen snapshots to an SD card. See **Register Products and Back up Data** for details.

Update Software Automatically

1. Press the POWER key. Follow the on-screen prompts to start normal mode on the control head.
2. Install the SD card with the software file(s) into the control head card slot.
3. A dialog box will display to start the software update.

To start the control head software update, select Install. When SUCCESS is displayed, the software update is finished. If you have accessories to update, proceed to **Update Accessories**. If you don't have any other software updates to install, power off the control head, and restart it.

OR

To update the software at a later time from the Files tool, select Cancel. If you select Cancel, see **Update Software from the Files Tool** in this section.

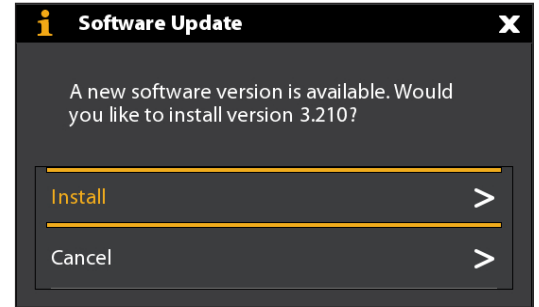

Update Software from the Files Tool

1. Install the SD card with the software file(s) into the control head card slot.
2. Press the HOME key.
3. Select the Files tool.
4. From the Software Update tab, scroll to This Unit.
5. Confirm that the most current version of software is selected from the list. Select Install Now.

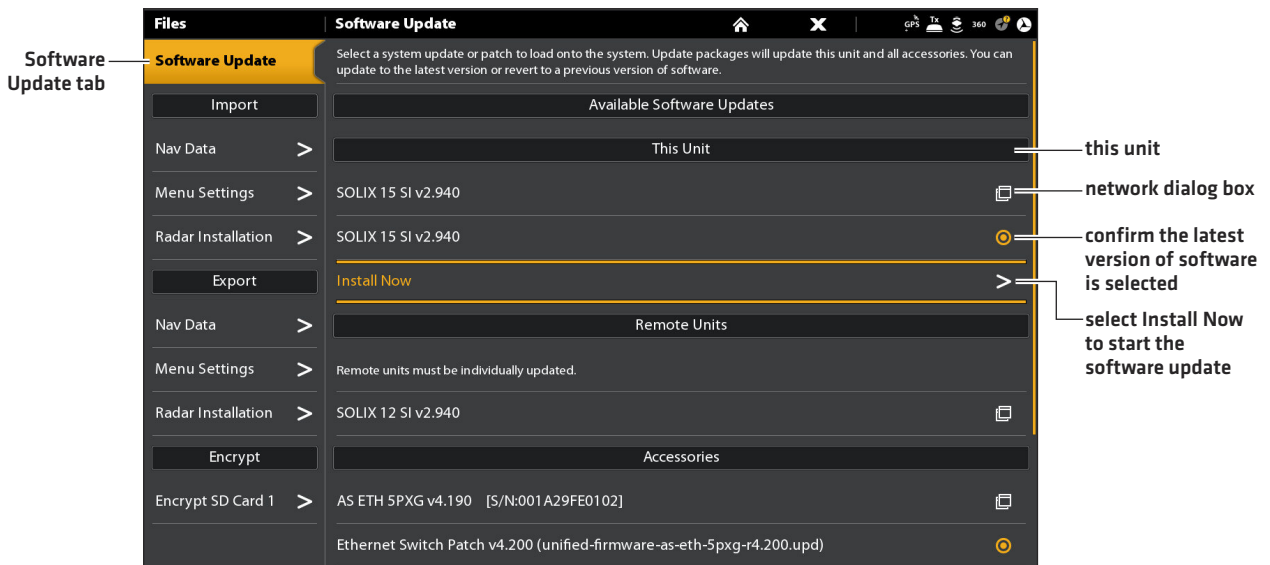

6. When SUCCESS is displayed, the software update is finished. If you have accessories to update, proceed to **Update Accessories**. If you don't have any other software updates to install, power off the control head, and restart it.

5 | Update Accessories

Accessory software is updated from the Files tool, and the process is similar to updating the control head software. It is important to review the following tips:

- Update the control head and accessories in the order they appear on the software update list in the Files Tool. **Sonar Black Boxes [SM3000]** and **Ethernet Switches** must be updated individually on the software update list.
- If an accessory is not displayed on the list, confirm it is detected on the network [Settings > Network > Network Info]. Also, confirm the cable connections are secure.
- You might notice that the control head will restart during the software update. This is part of the update process.
- The **i-Pilot Link** has separate software updates for the controller and remote. After the software is updated on the control head, you must go to the remote and initiate the download of the remote software to the remote itself. See your i-Pilot Link manual for details.

⚠ WARNING! Before the control head software is updated or restored to system defaults, export your menu settings, radar settings, and navigation data. Copy your screen snapshots to an SD card. See **Register Products and Back up Data** for details.

Update Accessories from the Files Tool

1. Install the SD card with the software file[s] into the control head card slot.
2. Press the HOME key. Select the Files tool.
3. From the Software Update tab, scroll to the first accessory in the list.
4. Confirm that the most current version of software is selected from the list. Select Install Now.

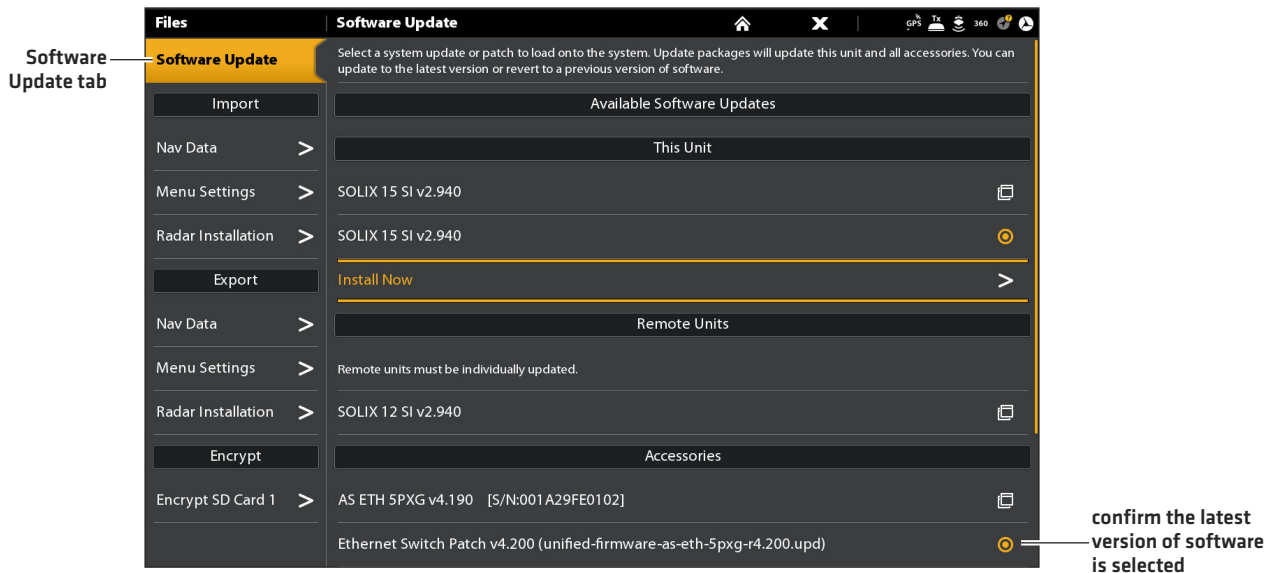

5. When the software update is finished, scroll to the next accessory update in the list (if applicable), and repeat step 4.
6. **Entire System Restart:** After all software has been updated, power off all control heads and connected equipment. Wait 10 seconds, and then power on all equipment.

SPECIFICATIONS

SOLIX

Control Head

SOLIX 12 Display Size [diagonal]	12.1 inches [307.3 mm]
SOLIX 15 Display Size [diagonal]	15.4 inches [391.16 mm]
Pixel Matrix	WXGA 1280 x 800
Display Type	TFT Color
Backlight	LED
Communication	NMEA 0183 Bus, NMEA 2000 Bus [LEN = 2], Ethernet
Power Requirement	12 VDC
Current Draw	SOLIX 12: 2.5 Amps SOLIX 15: 3.75 Amps
Recommended Fuse	SOLIX 12: 5 Amps [slow blow] SOLIX 15: 7.5 Amps [slow blow]
IPX Rating	IPX7 Waterproof/Submersible @ 1 m for 30 minutes

CHIRP DualBeam PLUS Transducer

XNT 14 20 T [includes built-in temperature probe]

Operating Frequency	200 kHz and 83 kHz
Depth Capability	1500 ft [457 m]
Area of Coverage	60°@-10 dB in 83 kHz, 20°@-10 dB in 200 kHz
Power Output [MAX]	500 Watts [RMS], 4000 Watts [Peak to Peak]



NOTE: Humminbird verifies maximum stated depth in saltwater conditions, but actual depth performance may vary due to transducer installation, water type, thermal layers, bottom composition, and slope.



NOTE: Product specifications and features are subject to change without notice.

Control Head

SOLIX 12 Display Size [diagonal]	12.1 inches [307.3 mm]
SOLIX 15 Display Size [diagonal]	15.4 inches [391.16 mm]
Pixel Matrix	WXGA 1280 x 800
Display Type	TFT Color
Backlight	LED
Communication	NMEA 0183 Bus, NMEA 2000 Bus [LEN = 2], Ethernet
Power Requirement	12 VDC
Current Draw	SOLIX 12: 2.5 Amps SOLIX 15: 3.75 Amps
Recommended Fuse	SOLIX 12: 5 Amps [slow blow] SOLIX 15: 7.5 Amps [slow blow]
IPX Rating	IPX7 Waterproof/Submersible @ 1 m for 30 minutes and dust tight

CHIRP MEGA Side Imaging Transducer**XM 14 20 MSI T** [includes built-in temperature probe]

Power Output [MAX]	500 Watts [RMS], 4000 Watts [Peak to Peak]
--------------------------	--

Side Imaging

Operating Frequency	455 kHz, 800 kHz, MEGA
Range Capability	455 kHz: 800 ft [244 m] Side to Side 800 kHz: 250 ft [76 m] Side to Side MEGA: 250 ft [76 m] Side to Side
Area of Coverage	[2] 86° @ -10 dB in 455 kHz [180° Total Coverage] [2] 55° @ -10 dB in 800 kHz [130° Total Coverage] MEGA: [2] 86° @ -10 dB in MEGA kHz [180° Total Coverage]

Down Imaging

Operating Frequency	455 kHz, 800 kHz, MEGA
Depth Capability	455 kHz: 800 ft [122 m] 800 kHz: 150 ft [38 m] MEGA: 125 ft [38 m]
Area of Coverage	75° @ -10 dB in 455 kHz 45° @ -10 dB in 800 kHz MEGA: 75° @ -10 dB in MEGA kHz

DualBeam PLUS

Operating Frequency	200 kHz and 83 kHz
Depth Capability	1500 ft (457 m)
Area of Coverage	60°@-10 dB in 83 kHz 20°@-10 dB in 200 kHz
Power Output [MAX]	500 Watts [RMS], 4000 Watts [Peak to Peak]



NOTE: Humminbird verifies maximum stated depth in saltwater conditions, but actual depth performance may vary due to transducer installation, water type, thermal layers, bottom composition, and slope.



NOTE: Product specifications and features are subject to change without notice.



SOLIX 12 In-Dash Mount (separate purchase required)

Width	13.8" [350.5 mm]
Height	8.2" [208.5 mm]
Depth	1.2" [30.5 mm]

SOLIX 12 Gimbal Mount

Width	13.8" [350.5 mm]
Height	8.7" [221 mm]
Depth	4.8" [122 mm]

SOLIX 15 Control Head Measurements



SOLIX 15 In-Dash Mount (separate purchase required)

Width	16.5" [419.9 mm]
Height	10.1" [256.5 mm]
Depth	1.2" [30.5 mm]

SOLIX 15 Gimbal Mount

Width	16.5" [419 mm]
Height	10.5" [266.7 mm]
Depth	4.8" [122 mm]

STATEMENTS AND ACKNOWLEDGEMENTS

ENVIRONMENTAL COMPLIANCE STATEMENT: It is the intention of Johnson Outdoors Marine Electronics, Inc. to be a responsible corporate citizen, operating in compliance with known and applicable environmental regulations, and a good neighbor in the communities where we make or sell our products.

WEEE DIRECTIVE: EU Directive 2002/96/EC "Waste of Electrical and Electronic Equipment Directive [WEEE]" impacts most distributors, sellers, and manufacturers of consumer electronics in the European Union. The WEEE Directive requires the producer of consumer electronics to take responsibility for the management of waste from their products to achieve environmentally responsible disposal during the product life cycle.

WEEE compliance may not be required in your location for electrical & electronic equipment (EEE), nor may it be required for EEE designed and intended as fixed or temporary installation in transportation vehicles such as automobiles, aircraft, and boats. In some European Union member states, these vehicles are considered outside of the scope of the Directive, and EEE for those applications can be considered excluded from the WEEE Directive requirement.



This symbol [WEEE wheeled bin] on product indicates the product must not be disposed of with other household refuse. It must be disposed of and collected for recycling and recovery of waste EEE. Johnson Outdoors Marine Electronics, Inc. will mark all EEE products in accordance with the WEEE Directive. It is our goal to comply in the collection, treatment, recovery, and environmentally sound disposal of those products; however, these requirements do vary within European Union member states. For more information about where you should dispose of your waste equipment for recycling and recovery and/or your European Union member state requirements, please contact your dealer or distributor from which your product was purchased.

Caldera Systems, Inc.

The following copyright and license is applicable to the OpenSLP project:

Copyright © 2000 Caldera Systems, Inc.

All rights reserved.

Redistribution and use in source and binary forms, with or without modification, are permitted provided that the following conditions are met:

- Redistributions of source code must retain the above copyright notice, this list of conditions and the following disclaimer.
- Redistributions in binary form must reproduce the above copyright notice, this list of conditions and the following disclaimer in the documentation and/or other materials provided with the distribution.
- Neither the name of Caldera Systems nor the names of its contributors may be used to endorse or promote products derived from this software without specific prior written permission.

THIS SOFTWARE IS PROVIDED BY THE COPYRIGHT HOLDERS AND CONTRIBUTORS "AS IS" AND ANY EXPRESS OR IMPLIED WARRANTIES, INCLUDING, BUT NOT LIMITED TO, THE IMPLIED WARRANTIES OF MERCHANTABILITY AND FITNESS FOR A PARTICULAR PURPOSE ARE DISCLAIMED. IN NO EVENT SHALL THE CALDERA SYSTEMS OR CONTRIBUTORS BE LIABLE FOR ANY DIRECT, INDIRECT, INCIDENTAL, SPECIAL, EXEMPLARY, OR CONSEQUENTIAL DAMAGES (INCLUDING, BUT NOT LIMITED TO, PROCUREMENT OF SUBSTITUTE GOODS OR SERVICES; LOSS OF USE, DATA, OR PROFITS; OR BUSINESS INTERRUPTION) HOWEVER CAUSED AND ON ANY THEORY OF LIABILITY, WHETHER IN CONTRACT, STRICT LIABILITY, OR TORT (INCLUDING NEGLIGENCE OR OTHERWISE) ARISING IN ANY WAY OUT OF THE USE OF THIS SOFTWARE, EVEN IF ADVISED OF THE POSSIBILITY OF SUCH DAMAGE.

libxml++



NOTE: This product uses libxml++ software. This portion of the software is free software; you can redistribute it and/or modify it under the terms of the GNU Lesser General Public License as published by the Free Software Foundation; either version 2 of the License, or [at your option] any later version. This program is distributed in the hope that it will be useful, but WITHOUT ANY WARRANTY; without even the implied warranty of MERCHANTABILITY or FITNESS FOR A PARTICULAR PURPOSE. See the GNU Lesser General Public License for more details.

You may receive a copy of the GNU Lesser General Public License along with this program; if not, write to the Free Software Foundation, Inc., 51 Franklin Street, Fifth Floor, Boston, MA 02110-1301 USA.

To receive a free copy of the libxml++ software used in this system, please send a letter of request* with the following information:

Name (First & Last)
Phone Number
E-mail Address
Mailing Address
Humminbird serial number
[Your Humminbird unit must be registered at humminbird.com/support/productregistration.aspx.]

Shipping and Handling:

We can only accept requests that include a money order in the amount of \$9.99 to cover shipping and handling. Please allow 4-6 weeks for processing.

Send the letter of request* to the following address:

Software Request
Humminbird
678 Humminbird Lane
Eufaula, AL 36027

***NOTE:** A copy of the libxml++ software is not required to upgrade your fishing system. The Humminbird application software and control head include a separate service warranty. Please see humminbird.com and the separate warranty card included with your unit for details.

libxml12 (The MIT License)

Except where otherwise noted in the source code [e.g. the files hash.c, list.c and the trio files, which are covered by a similar license but with different Copyright notices] all the files are:

Copyright © 1998-2003 Daniel Veillard. All Rights Reserved.

Permission is hereby granted, free of charge, to any person obtaining a copy of this software and associated documentation files [the "Software"], to deal in the Software without restriction, including without limitation the rights to use, copy, modify, merge, publish, distribute, sublicense, and/or sell copies of the Software, and to permit persons to whom the Software is furnished to do so, subject to the following conditions:

The above copyright notice and this permission notice shall be included in all copies or substantial portions of the Software.

THE SOFTWARE IS PROVIDED "AS IS", WITHOUT WARRANTY OF ANY KIND, EXPRESS OR IMPLIED, INCLUDING BUT NOT LIMITED TO THE WARRANTIES OF MERCHANTABILITY, FITNESS FOR A PARTICULAR PURPOSE AND NONINFRINGEMENT. IN NO EVENT SHALL THE DANIEL VEILLARD BE LIABLE FOR ANY CLAIM, DAMAGES OR OTHER LIABILITY, WHETHER IN AN ACTION OF CONTRACT, TORT OR OTHERWISE, ARISING FROM, OUT OF OR IN CONNECTION WITH THE SOFTWARE OR THE USE OR OTHER DEALINGS IN THE SOFTWARE.

Except as contained in this notice, the name of Daniel Veillard shall not be used in advertising or otherwise to promote the sale, use or other dealings in this Software without prior written authorization from him.

Linux Operating System



NOTE: This product uses the Linux operating system. This portion of the software is free software; you can redistribute it and/or modify it under the terms of the GNU General Public License as published by the Free Software Foundation; either version 2 of the License, or [at your option] any later version. This program is distributed in the hope that it will be useful, but WITHOUT ANY WARRANTY; without even the implied warranty of MERCHANTABILITY or FITNESS FOR A PARTICULAR PURPOSE. See the GNU General Public License for more details.

You may receive a copy of the GNU General Public License along with this program; if not, write to the Free Software Foundation, Inc., 51 Franklin Street, Fifth Floor, Boston, MA 02110-1301 USA.

To receive a free copy of the Linux software used in this system, please send a letter of request* with the following information:

Name (First & Last)
Phone Number
E-mail Address
Mailing Address
Humminbird serial number
(Your Humminbird unit must be registered at humminbird.com/support/productregistration.aspx.)

Shipping and Handling:

We can only accept requests that include a money order in the amount of \$9.99 to cover shipping and handling. Please allow 4-6 weeks for processing.

Send the letter of request* to the following address:

Software Request
Humminbird
678 Humminbird Lane
Eufaula, AL 36027

***NOTE:** A copy of the Linux operating system is not required to upgrade your fishing system. The Humminbird application software and control head include a separate service warranty. Please see humminbird.com and the separate warranty card included with your unit for details.

Macho (C++ Machine Objects) (The MIT License)

The Machine Objects class library [in short Macho] allows the creation of state machines based on the "State" design pattern in straight C++. It extends the pattern with the option to create hierarchical state machines, making it possible to convert the popular UML statechart notation to working code in a straightforward way. Other features are entry and exit actions, state histories and state variables.

Copyright © 2005 by Eduard Hiti [feedback to reverse:de.ehiti@macho]

Permission is hereby granted, free of charge, to any person obtaining a copy of this software and associated documentation files [the "Software"], to deal in the Software without restriction, including without limitation the rights to use, copy, modify, merge, publish, distribute, sublicense, and/or sell copies of the Software, and to permit persons to whom the Software is furnished to do so, subject to the following conditions:

The above copyright notice and this permission notice shall be included in all copies or substantial portions of the Software.

THE SOFTWARE IS PROVIDED "AS IS", WITHOUT WARRANTY OF ANY KIND, EXPRESS OR IMPLIED, INCLUDING BUT NOT LIMITED TO THE WARRANTIES OF MERCHANTABILITY, FITNESS FOR A PARTICULAR PURPOSE AND NONINFRINGEMENT. IN NO EVENT SHALL THE AUTHORS OR COPYRIGHT HOLDERS BE LIABLE FOR ANY CLAIM, DAMAGES OR OTHER LIABILITY, WHETHER IN AN ACTION OF CONTRACT, TORT OR OTHERWISE, ARISING FROM, OUT OF OR IN CONNECTION WITH THE SOFTWARE OR THE USE OR OTHER DEALINGS IN THE SOFTWARE.

You are encouraged to provide any changes, extensions and corrections for this software to the author at the above-mentioned email address for inclusion into future versions.

Navionics



WARNINGS: The electronic chart is an aid to navigation designed to facilitate the use of authorized government charts, not to replace them. Only official government charts and notices to mariners contain all information needed for the safety of navigation, and as always, the captain is responsible for their prudent use.

ACKNOWLEDGEMENT OF THIRD PARTY NOTICES AND COPYRIGHT LICENSES: This product may contain cartography and other data from one or more of the following Third Party sources; to the extent that any such source is used, the relevant provisions below shall apply:

“National Oceanic and Atmospheric Administration [NOAA]”, “National Imagery Mapping Agency [NIMA]”, “National Geospatial-Intelligence Agency [NGA]”, “National Agriculture Imagery Program [NAIP]”, “United States Army Corps of Engineers [USACE]”, “United States Geological Survey [USGS], Digital Line Graphic [DLG], Digital Raster Graphic [DRG]”, “Department of Natural Resources [DNR]”, “United States Department of Defense”, “United States Department of Commerce, Bureau of Public Roads & State’s Highway Commission”, “Department of Environmental Protection [DEP]”, “Department of Fish and Wildlife”, “Department of Game and Fishing”, “Ocean Mapping Group, Department of Geodesy and Geomatics Engineering, University of New Brunswick”, “Pennsylvania Fish and Boat Commission [PFBC]”, “Florida Natural Areas Inventory [FNAI]”, “North Carolina Wildlife Resources Commission [NCWRC]”, “New York State, Department of Environmental Conservation”, “National Geophysical Data Center & Great Lakes Environmental Research Laboratory - Great Lakes Information Network”, “Imray Charts”, “Wavey Line Charts Publishing”, “Angler Atlas”, “Fish-n-Map Company”, “Track Map Data”, “Servicio de Hidrografia Naval [SHN], Argentina”, “Western Australia Department of Planning and Infrastructure [DPIWA]”, “Australian Hydrographic Service [AHS]”, “Maritime Safety Agency of State of Queensland [MSQ]”, “@The State of Queensland [Department of the Environment and Resource Management] [DERM]”, “I-Cubed”, “GeoContent”, “DigitalGlobe”, “European Environment Agency [Corine]”, “Algemene Nederlandsche Wielsrijders Bond [ANWB]”, “© Dutch Ministry of Infrastructure and Environment”, “Dienst Der Hydrografie, Netherlands”, “Vlaamse Hydrografie, Belgium”, “Belgium National Oceanographic Data Centre [BMDC]”, “Management Unit of the North Sea Mathematical Models [MUMM]”, “Landesvermessungsamt Baden-Wurttemberg”, “Bundesamt für Seeschifffahrt und Hydrographie [BSH]”, “Bundesministerium für Verkehr, Bau und Stadtentwicklung – Die Wasser- und Schifffahrtsverwaltung des Bundes [WSW], Germany”, “Geodatastyrelsen [GST]”, “Delius Klasing Verlag [DKV]”, “Estonian Maritime Administration [EMA]”, “Finnish Maritime Administration [FMA]”, “National Land Survey [NLS]”, “Service Hydrographique et Oceanographique de la Marine [SHOM]”, “Hellenic Navy Hydrographic Service [HNHS]”, “Hrvatski Hidrografski Institute [HHI], Croatia”, “Icelandic Coast Guard [ICG]”, “Istituto Idrografico della Marina, Italia”, “Ministero dello Sviluppo Economico, Italia”, “Japan Hydrographic Department”, “Norwegian Hydrographic Service [Statens Kartverk Interreg Geovekst]”, “Nordeca SA”, “Myosa Boating Union”, “State Hydrographic Service Ukraine [SHSU]”, “United Kingdom Hydrographic Office [UKHO], ©British Crown Copyright, [2013]”, “British Oceanographic Data Centre [BODC] and the Environment Agency”, “Channel Coastal Observatory”, “IHO-IOC GEBCO Gazetteer of Undersea Feature Names, Bathymetric Contours derived from the GEBCO_08 Grid and GEBCO One Minute Grid; www.gebco.net”, “United Kingdom Department of Energy and Climate Control”, “The database of British and Irish Hills by Graham Jackson and Chris Crocker”, “Swedish Maritime Administration [SMA]”, “Hydrographica AB”, “Instituto Hidrográfico, Portugal [IHPT]”, “Instituto Hidrográfico de la Marina, España [IHM]”, “Ministerio de Agricultura, Alimentación y Medio Ambiente, España [MAGRAMA]”, “Departamento de Medio Ambiente, Planificación Territorial, Agricultura y Pesca, Gobierno Vasco”, “National Hydrographic Office, Sultanate of Oman [NHOSO]”, “South Africa Navy Hydrographic Office [SAN]”, “@ Swisstopo”, “Swiss Lakes Charts with the permission from Cap.Jean DeBosset”, “Abris LLC”, “GeoNames”, “Claymoreclan Design”, “Reliance Globalcom”, “Kingfisher Information Services by Seafish.Org”, “Land Information New Zealand [LINZ]”

This Navionics electronic marine chart incorporates Data which is © “Commonwealth of Australia [“Great Barrier Reef Marine Park Authority”]” 2009. The Data has been used in this Navionics electronic marine chart with the permission of the Commonwealth. The Commonwealth has not evaluated the Data as altered and incorporated within this Navionics electronic marine chart, and therefore gives no warranty regarding its accuracy, completeness, currency or suitability for any particular purpose.

The “Crown in Right of the State of Western Australia” accepts no liability for the accuracy of copying of information contained in this product and does not warrant that this product meets any regulations as an appropriate product for navigation.

This product has been produced by Navionics S.p.A. based on “Canadian Hydrographic Service [CHS]” data, following any minimum standards/guidelines that may have been established by CHS, pursuant to CHS Digital Value-Added Reseller Agreement No. 2012-0605-1260-N. The incorporation of data sourced from CHS in this product shall not be construed as constituting an endorsement by CHS of this product. This product does not meet the requirements of the Charts and Nautical publications Regulations under the Canada Shipping Act, 2001. Certified charts and publications, corrected and up-to-date, must be used to meet the requirements of those regulations.

All above Companies, Institutions and Hydrographic Offices have not verified the product and do not accept liability for its accuracy.

Copyright © 2013 Navionics S.p.A.

Qt Project



NOTE: This product uses Qt software. Qt is licensed under commercial and open source licenses [GNU General Public License version 3 and GNU Lesser General Public License version 2.1]. This portion of the software is free software; you can redistribute it and/or modify it under the terms of the GNU General Public License and GNU Lesser General Public License as published by the Free Software Foundation; either version 3 of the GNU General Public License and version 2.1 of the GNU Lesser General Public License, or [at your option] any later version. This program is distributed in the hope that it will be useful, but WITHOUT ANY WARRANTY; without even the implied warranty of MERCHANTABILITY or FITNESS FOR A PARTICULAR PURPOSE. See the GNU General Public License and GNU Lesser General Public License for more details.

You may receive a copy of the GNU General Public License and GNU Lesser General Public License along with this program; if not, write to the Free Software Foundation, Inc., 51 Franklin Street, Fifth Floor, Boston, MA 02110-1301 USA.

To receive a free copy of the Qt software used in this system, please send a letter of request* with the following information:

Name (First & Last)
Phone Number
E-mail Address
Mailing Address
Humminbird serial number
[Your Humminbird unit must be registered at humminbird.com/support/productregistration.aspx.]

Shipping and Handling:

We can only accept requests that include a money order in the amount of \$9.99 to cover shipping and handling. Please allow 4-6 weeks for processing.

Send the letter of request* to the following address:

Software Request
Humminbird
678 Humminbird Lane
Eufaula, AL 36027

***NOTE:** A copy of the Qt software is not required to upgrade your fishing system. The Humminbird application software and control head include a separate service warranty. Please see humminbird.com and the separate warranty card included with your unit for details.

FCC Notice

This device complies with Part 15 of the FCC Rules. Operation is subject to the following two conditions: [1] this device may not cause harmful interference, and [2] this device must accept any interference received, including interference that may cause undesired operation.

FCC CAUTION STATEMENT

This equipment has been tested and found to comply with the limits for a Class B digital device, pursuant to Part 15 of the FCC Rules. These limits are designed to provide reasonable protection against harmful interference in a residential installation. This equipment generates, uses and can radiate radio frequency energy and, if not installed and used in accordance with the instructions, may cause harmful interference to radio communications. However, there is no guarantee that interference will not occur in a particular installation. If this equipment does cause harmful interference to radio or television reception, which can be determined by turning the equipment off and on, the user is encouraged to try to correct the interference by one or more of the following measures:

- Reorient or relocate the receiving antenna.
- Increase the separation between the equipment and receiver.
- Connect the equipment into an outlet on a circuit different from that to which the receiver is connected.
- Consult the dealer or an experienced radio/TV technician for help.

Class B Device (Broadcasting and communication equipment for home)

This equipment is home use [Class B] electromagnetic wave suitability equipment and to be used at home and it can be used in all areas.

CONTACT HUMMINBIRD

Contact Humminbird Customer Service in any of the following ways:

Web site:

humminbird.com

E-mail:

service@humminbird.com

Telephone:

1-800-633-1468

Direct Shipping:

Humminbird
Service Department
678 Humminbird Lane
Eufaula, AL 36027 USA

Hours of Operation:

Monday - Friday

8:00 a.m. to 4:30 p.m. [Central Standard Time]

Social Media Resources:



[Facebook.com/HumminbirdElectronics](https://www.facebook.com/HumminbirdElectronics)



[Twitter.com \[@humminbirdfish\]](https://twitter.com/@humminbirdfish)



[YouTube.com/humminbirdtv](https://www.youtube.com/humminbirdtv)

