



a xylem brand

Standard Drain Box

INSTRUCTION MANUAL

- FR** Manuel d'utilisation d'évacuation d'eau de douche
- DE** Bedienungsanleitung für das Duschbecken-Entleerungssystem
- IT** Manuale delle istruzioni per la scatola di scarico della doccia
- NL** Handleiding douche-afvoerbak
- SE** Användarhandledning för duschutloppsbox
- ES** Manual de instrucciones de la caja de desagüe de ducha



rule

a xylem brand

WARNING



This unit is designed for use with fresh water and salt water **ONLY**. Use with any other hazardous, caustic, or corrosive material could result in damage to the pump and the surrounding environment, possible exposure to hazardous substances and injury.

AVERTISSEMENT

FR



Cette unité est conçue pour être utilisée **UNIQUEMENT** avec de l'eau douce ou de l'eau salée. L'utilisation de tout autre matériau dangereux, caustique ou corrosif pourrait endommager la pompe et l'environnement alentours et entraîner une exposition à des substances dangereuses ou des blessures.

WARNHINWEIS

DE



Diese Vorrichtung ist **NUR** für den Einsatz in Süß- und Salzwasser geeignet. Der Kontakt mit anderen gefährlichen, ätzenden oder reizenden Flüssigkeiten kann zu Beschädigungen der Pumpe und Umgebung, möglicher Freisetzung von gefährlichen Stoffen und zu Verletzungen führen.

AVVERTENZA

L'unità deve essere usata **SOLAMENTE** con acqua dolce o salata. L'uso con altro materiale pericoloso, caustico o corrosivo può danneggiare le pompa e l'ambiente circostante e causare l'esposizione a sostanze pericolose e infortuni alla persona.

IT

**WAARSCHUWING**

Deze unit is ontworpen voor gebruik met **UITSLUITEND** zoetwater en zoutwater. Gebruik met enig ander gevaarlijk, bijtend of corrosief materiaal kan resulteren in schade aan de pomp en de omgeving, mogelijke blootstelling aan gevaarlijke stoffen en letsel.

NL

**VARNING**

Denna enhet är konstruerad **ENDAST** för bruk med söt- och saltvatten. Användning med andra farliga, frätande eller brännande material kan resultera i skada på pump och den omgivande miljön, möjlig exponering för farliga ämnen och personskada.

SE

**ADVERTENCIA**

Esta unidad está diseñada para usar con agua dulce y salada **ÚNICAMENTE**. Si se usa con cualquier otro material peligroso, cáustico o corrosivo, pueden ocasionarse daños a la bomba y al medio ambiente circundante, posible exposición a sustancias peligrosas y lesiones.

ES



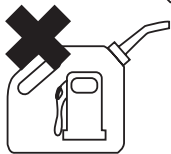
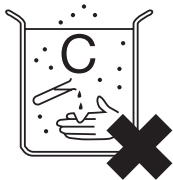

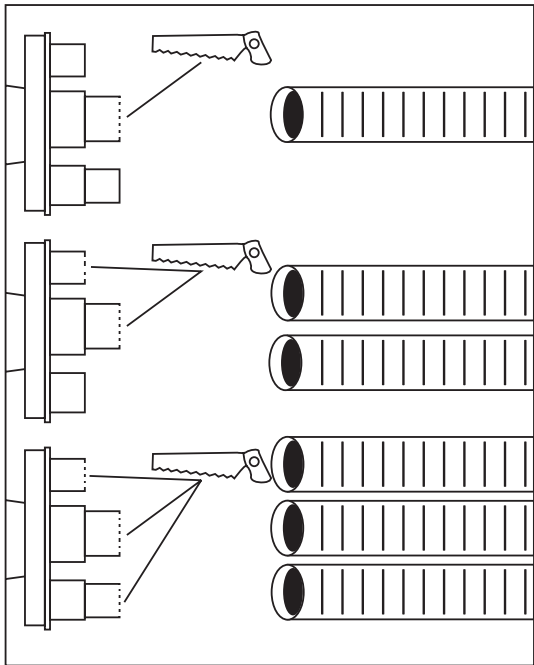

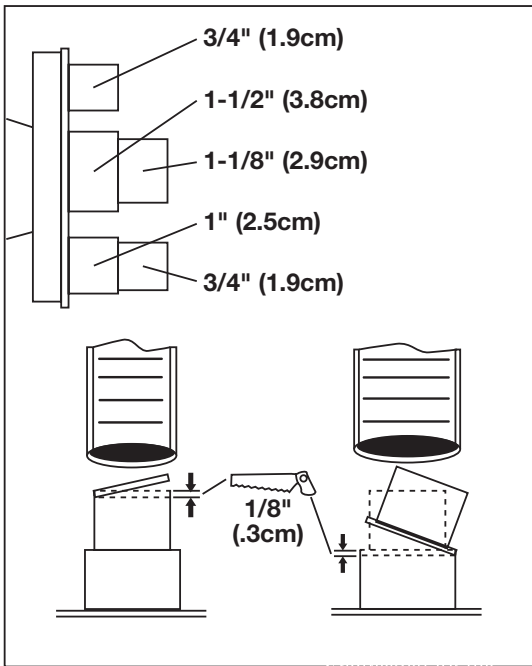

- CLEANING
- NETTOYAGE
- REINGUNG
- PULIZIA
- REINGING
- RENGÖRING
- LIMPIEZA

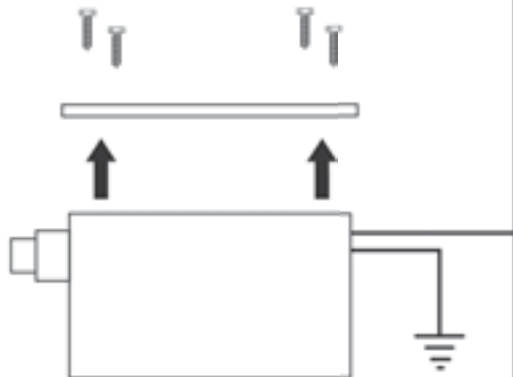

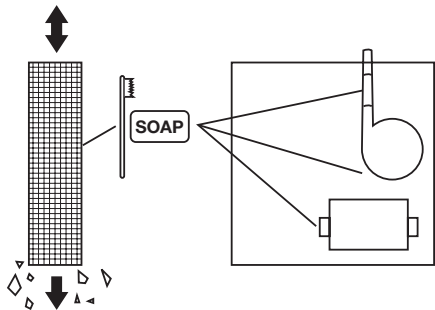
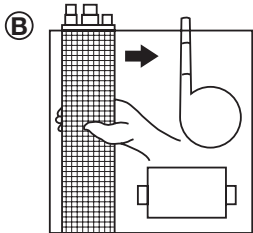
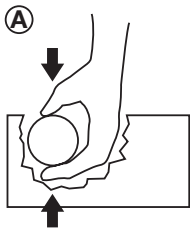

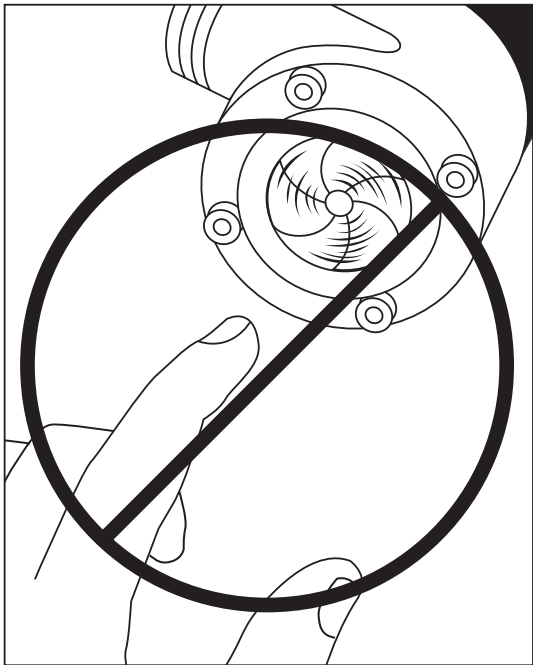

All mounting holes must be sealed with a marine grade sealant to prevent water intrusion.



FR

Tous les trous de fixation doivent être rendus étanches à l'aide d'un mastic marine pour éviter toute pénétration d'eau.

DE

Alle Montagebohrungen müssen mit einem für Marineanwendungen geeigneten Dichtmittel abgedichtet werden, um das Eindringen von Wasser zu verhindern.

IT

Per evitare l'intrusione dell'acqua, sigillare tutti i fori di montaggio con un sigillante di qualità marina.

NL

Een zeewatervaste kit moet voor alle montageopeningen gebruikt worden om indringing van zeewater te vermijden.

SE

Alla monteringshål måste förseglas med ett tätningsmedel för båtar för att hindra vatten från att tränga in.

ES

Todos los orificios de montaje deben sellarse con un sellador de grado marino para evitar la entrada de agua.

ABYC
Setting Standards for Safer Boating

Install to ABYC standards H-2 and E11

FR

Installation conformément aux normes H-2 et E11 de ABYC.

DE

In Übereinstimmung mit den ABYC-Normen H-2 und E-11 installieren.

IT

Installare secondo gli standard ABYC H-2 e E-11.

NL

Installeren volgens ABYC normen H-2 en E11

SE

Installera i enlighet med ABYC-standard H-2 och E11.

ES

Instalar según las normas H-2 y E11 del ABYC.



CE Logo

When this product carries a CE mark, it conforms to one or more of the following standards: EN 61000-6-1:2001

EN 61000-6-3:2007

Following the Provisions of the Electromagnetic Compatibility Directive 2004/108/EC
ISO 8846 / Electrical Devices Protection Against Ignition of Surrounding Flammable Gases
ISO 10133:2000 / Electrical Systems - Extra Low Voltage D.C. Installations Following the Provisions of the Recreation Craft Directive 94/25/EEC



Keep all wire connections above the highest water level. Wires must be joined with butt connectors and a marine grade sealant to prevent wire corrosion.

FR



Maintenir tous les raccords électriques au-dessus du niveau d'eau le plus élevé. Les fils doivent être raccordés avec des connecteurs bout à bout et un mastic marine pour empêcher la corrosion des conducteurs.

DE



Darauf achten, dass sich alle Kabelverbindungen stets oberhalb des Wasserspiegels befinden. Drähte müssen mit Stoßverbindern verbunden und zum Rostschutz mit einem geeigneten Dichtmittel behandelt werden.

IT



Mantenere tutti i collegamenti dei fili elettrici al di sopra del livello più alto dell'acqua. Per evitarne la corrosione, i fili elettrici devono essere congiunti con connettori a pressione diretta e sigillante specifico per uso marino.

NL



Houd alle draadverbindingen boven het hoogste waterniveau. De draden moeten worden samengehouden met een kabelverbinder en zeewatervaste kit. Dit om corrosie van de draden te voorkomen.

SE



Håll alla ledningsanslutningar ovanför den högsta vattennivån. Ledningar måste kopplas ihop med stumkontakter och förseglingsmedel för marint bruk för att förhindra ledningskorrosion.

ES



Mantenga todas las conexiones de cables por arriba del máximo nivel del agua. Los cables deben empalmarse con conectores de tope y un sellador de grado marino, a fin de evitar la corrosión de los mismos.

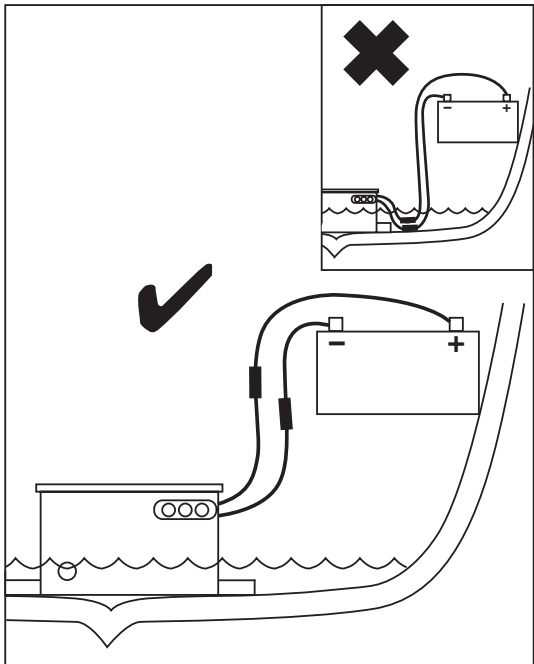



Always install proper fuse size to prevent damage to product should a short occur. Failure to install proper fuse could increase risk of pump malfunction potentially resulting in personal injury and/or fire hazard.

FR



Toujours installer la taille de fusible appropriée pour éviter d'endommager le produit en cas de court-circuit, faute de quoi la pompe pourrait mal fonctionner et entraîner des blessures et/ou des dangers d'incendie.

DE



Immer die richtige Sicherungsstärke installieren, um im Fall eines Kurzschlusses eine Beschädigung des Geräts zu vermeiden. Die Verwendung der falschen Sicherungsstärke kann zu einem Versagen der Pumpe und damit möglicherweise zu Verletzungen und/oder Feuergefahr führen.

IT



Per evitare danni al prodotto in caso di cortocircuito, installare sempre fusibile della dimensione corretta. Se viene installato un fusibile scorretto, il rischio di malfunzionamento della pompa aumenta, con il pericolo d'infortunio alla persona e/o d'incendio.

NL



Monteer altijd de juiste zekering om schade te voorkomen aan het product bij kortsluiting. Nalaten de juiste zekering te installeren, kan het risico op storingen aan de pomp verhogen, met eventueel persoonlijk letsel en/of brandgevaar tot gevolg.

SE



Installera alltid rätt säkringsstorlek för att produktskada ifall av kortslutning. Underlåtelse att installera rätt säkring kan öka risken för pumpfel med ris för personskada och/eller brand som resultat.

ES



Instale siempre fusibles de tamaño apropiado para evitar daños al producto en caso de cortocircuito. Si no se instala el fusible del tamaño adecuado, puede aumentar el riesgo de fallas de la bomba que pueden ocasionar potencialmente lesiones y/o peligros de incendio.

- GRAY WIRE - POSITIVE
- FIL GRIS - POSITIF
- GRAUES KABEL - POSITIV
- FILO GRIGIO - POSITIVO
- GRUZE DRAAD - POSITIEF
- GRÅ LEDNING - POSITIV
- CABLE GRIS - POSITIVO

- FUSE - SEE CHART
- FUSIBLE - VOIR LE DIAGRAMME
- SICHERUNG - SIEHE TABELLE
- FUSIBILE - VEDI TABELLA
- ZEKERING - ZIE TABEL
- SÄKRING - SE DIAGRAM
- FUSIBLE - VEA EL CUADRO

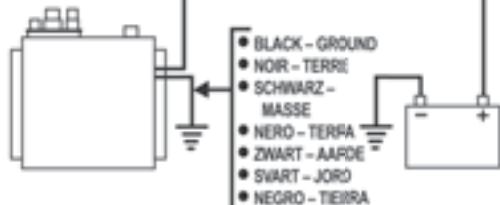



Disconnect power from the system before working on the unit to avoid personal injury, damage to the surrounding environment and/or damage to the unit.

FR



Déconnecter la source d'alimentation électrique du système avant d'effectuer toute réparation ou entretien pour éviter les blessures et d'endommager l'environnement alentours et/ou l'unité.

DE



Zur Vermeidung von Verletzungen, Umgebungs- und/oder Gerätebeschädigung vor jeglichen Arbeiten an der Einheit die Stromzufuhr trennen.

IT



Per evitare infortuni alla persona, danni all'ambiente circostante e/o all'unità, staccare sempre l'alimentazione dal sistema prima di lavorare sull'unità.

NL



Schakel de stroomtoevoer naar het systeem uit voordat u aan de unit begint te werken. Dit om persoonlijk letsel, schade aan de omgeving en/of de unit te voorkomen.

SE



Koppla från strömtillförseln från systemet innan du börjar arbeta på enheten för att undvika personskada, skada på omgivningen och/eller produktskada.

ES



Desconecte la alimentación eléctrica del sistema antes de trabajar en la unidad, a fin de evitar lesiones personales, daños al medio ambiente circundante y/o a la unidad.

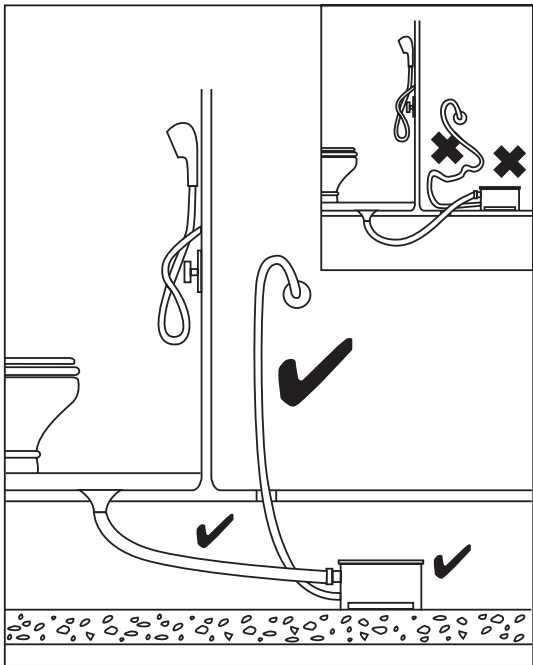

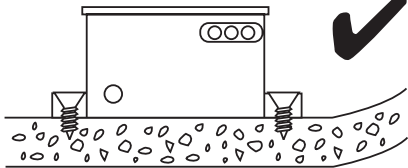
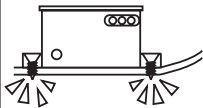
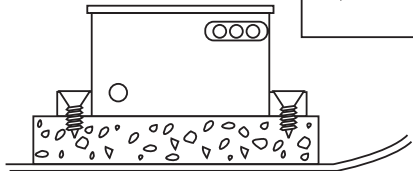

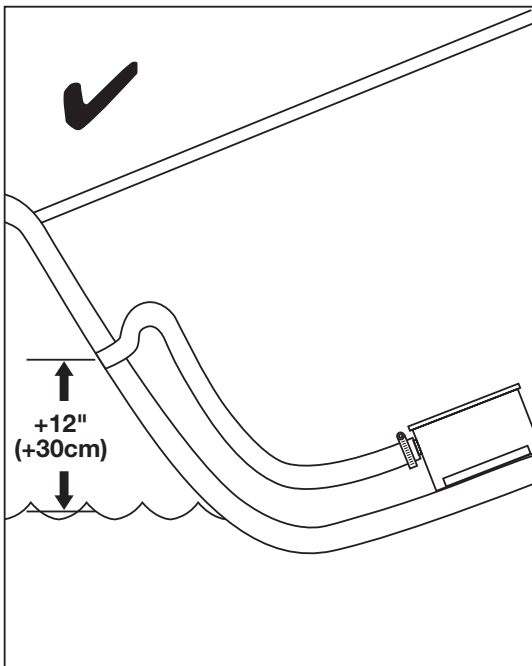

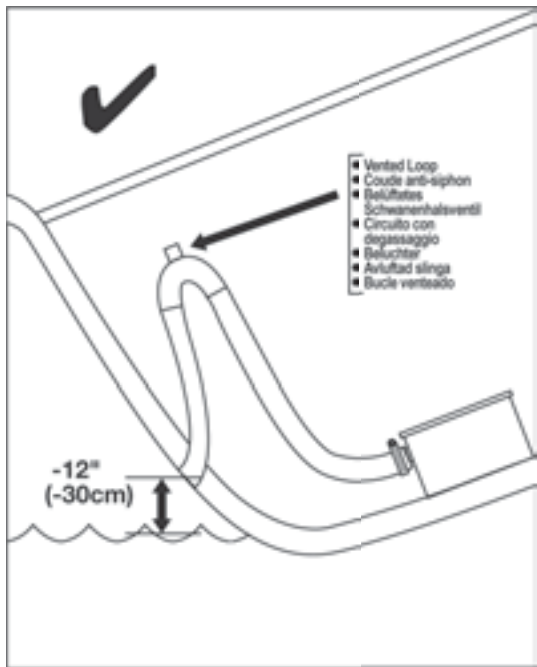

	A	B	C	D	E
	Model	Discharge	Voltage	Amp Draw	Fuse Size
(FR)	Modèle	Évacuation	Tension	Tirage amp.	Taille de fusible
(DE)	Modell	Entleerung	Spannung	Leistungsaufnahme	Sicherungsstärke
(IT)	Modello	Scarico	Tensione	Ampere assorbite	Dimensione fusibile
(NL)	Model	Afvoer	Spanning	Amp. stoot	Zekering
(SE)	Modell	Utlopp	Spänning	Strömförbrukning	Säkringsstorlek
(ES)	Modelo	Descarga	Voltaje	Consumo	Tamaño del fusible

A	B	C	D	E
97A	3/4" (19mm)	12V	2.0A	3.0A
97A-24	3/4" (19mm)	24V	1.3A	1.5A
98A	3/4" (19mm)	12V	4.0A	5.0A
98A-24	3/4" (19mm)	24V	2.0A	3.0A



rule
a xylem brand

www.xylemflowcontrol.com

Rule is a trademark of Xylem Inc. or one of its subsidiaries.

© 2012 Xylem, Inc.

950-0521

Rev. C 10/2012